

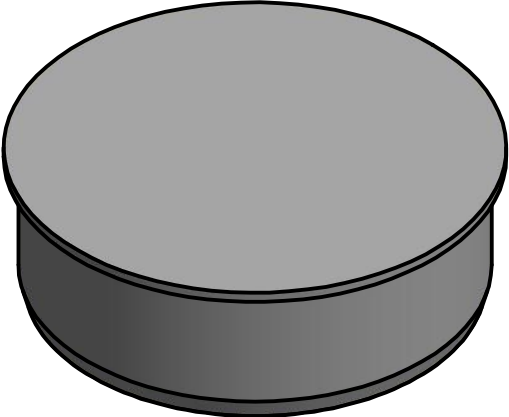

A-A (1 : 2)

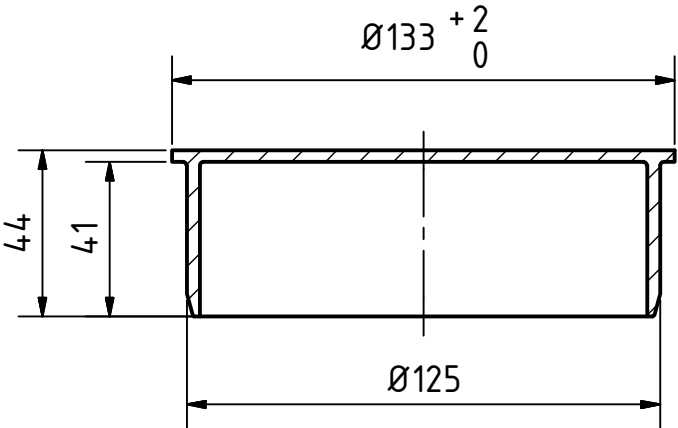
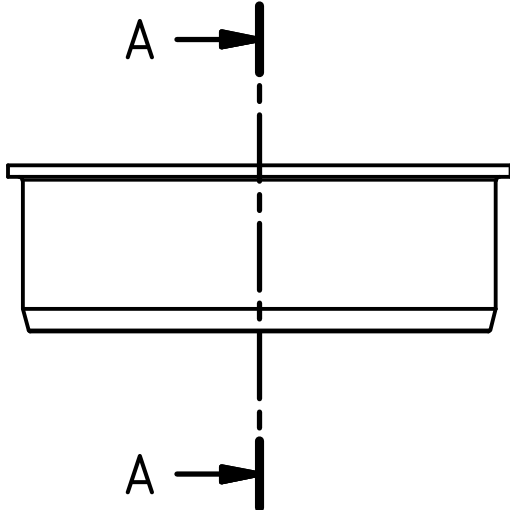

		Maße nach DIN EN 1451-1		Art.Nr.: 116620		Maßstab 1:2		
				Material: PP-H schwerentflammbar				
		Datum		Name		<h1>HT-System PP</h1>		
		Gezeichnet: 04.10.2016		A.Schmedes				
		Kontroll.						
Status	Änderungen	Datum	Name	Norm				
Gebr. Ostendorf Kunststoffe GmbH Rudolf-Diesel-Str. 6-8 D-49377 Vechta verkauf@ostendorf-kunststoffe.com www.ostendorf-kunststoffe.com						HTM Muffenstopfen DN/OD 125		1 A3
						Schutzvermerk nach DIN ISO 16016 beachten!		