

KALDEWEI

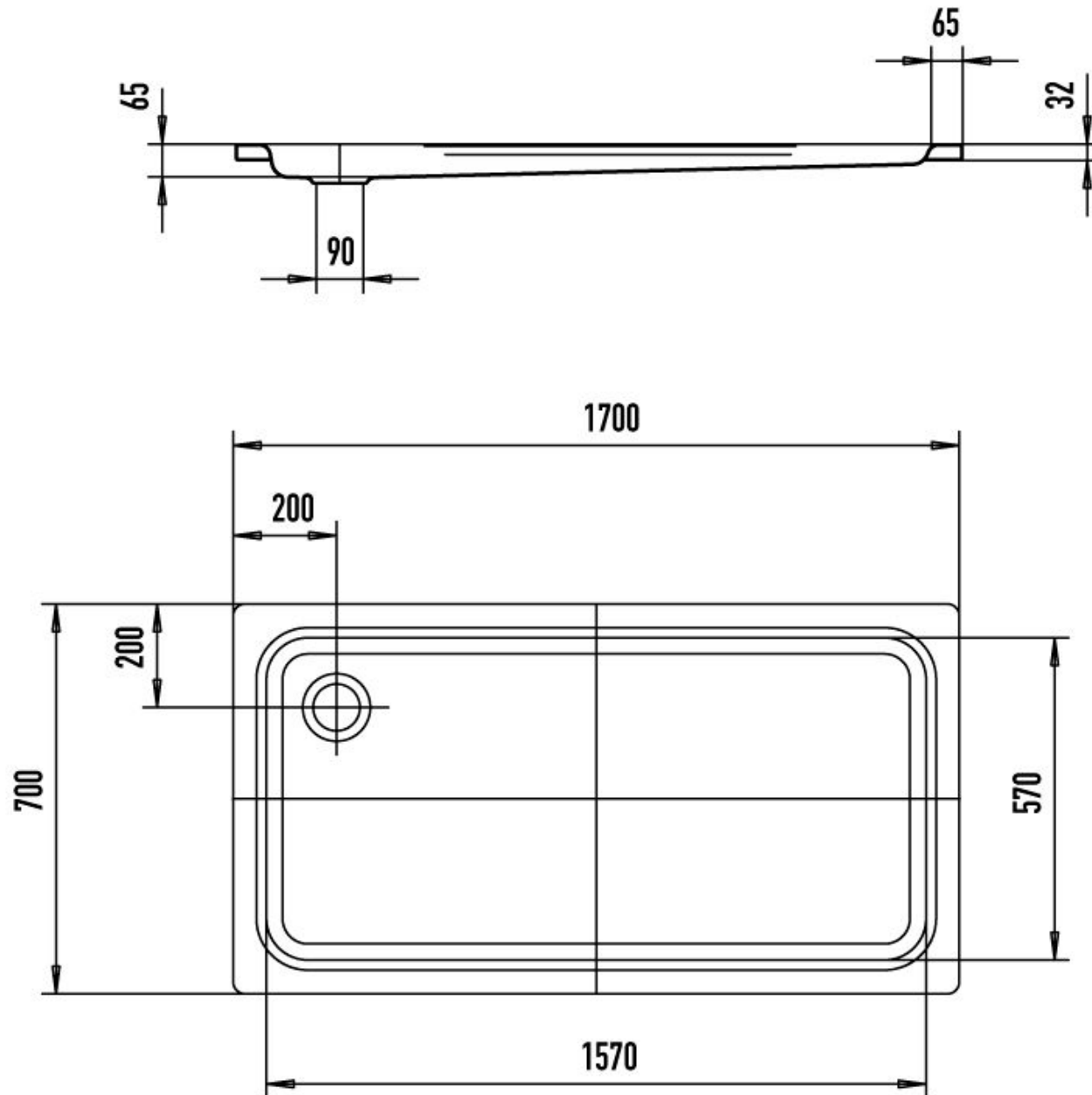

**DUSCHPLAN
424-1**