

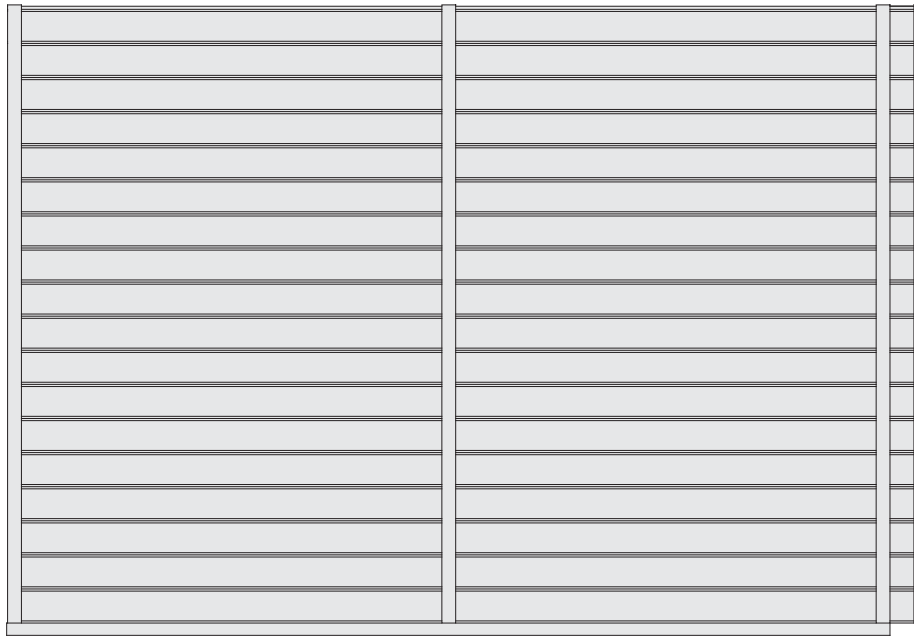

77287 7786

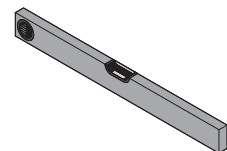

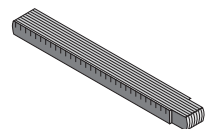
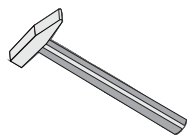
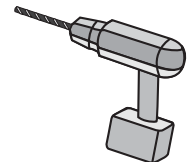
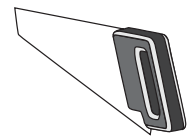

-  **Aufbauanleitung**
-  **Building Instructions**
-  **notice de montage**
-  **montagehandleiding**
-  **Montagevejledning**
-  **Instrucciones de construcción**
-  **Istruzioni per il montaggio**
-  **Montážní návod**

 **+49 421 38693 33**





 Vergleichen Sie zuerst die Material-liste mit Ihrem Paketinhalt! Bitte haben Sie Verständnis, dass Beanstandungen nur im nicht aufgebauten Zustand bearbeitet werden können!

 Vergelijk eerst de lijst van materialen met de inhoud van uw pakket! Reclamaties kunnen alleen in behandeling worden genomen zolang de onderdelen nog niet zijn gemonteerd!

 Confrontate questa distinta materiali prima con il contenuto del pacchetto! Vi preghiamo di comprendere che eventuali reclami possono essere accolti solo prima del montaggio!

 First compare the list of materials with your package contents! Please understand that complaints can be processed in the non-built status only!

 Start med at kontrollere materialelisten med indholdet af den leverede pakke! Vi gør venligst opmærksom på at reklamationer kun kan behandles for materialer som ikke er blevet bearbejdet!

 Nejprve přezkontrolujte obsah balení podle materiálového listu! Mějte pochopení pro to, že případnou reklamaci se můžeme zabývat pouze tehdy, když díly nebudou smontované! Za pomoci tohoto seznamu můžete jednotlivé díly přiřadit k montážnímu návodu.

 Commencez par comparer la liste du matériel avec le contenu de votre paquet! Sachez que nous traitons uniquement les réclamations concernant le matériel à l'état non monté!

 En primer lugar, compare la lista de material con el contenido del paquete. Rogamos entienda que las reclamaciones sólo pueden ser tramitadas antes de montar el objeto!

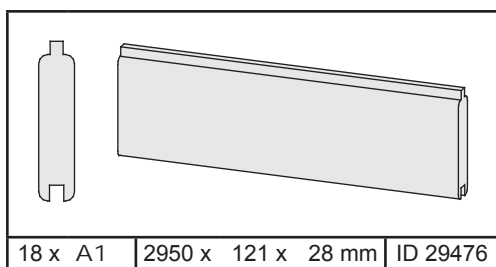
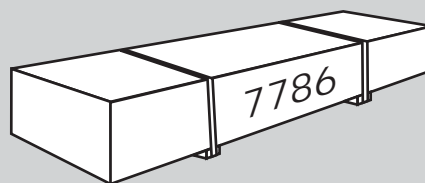
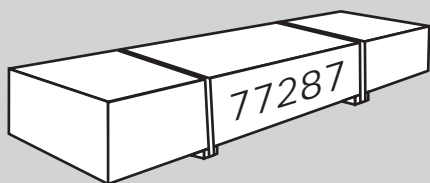



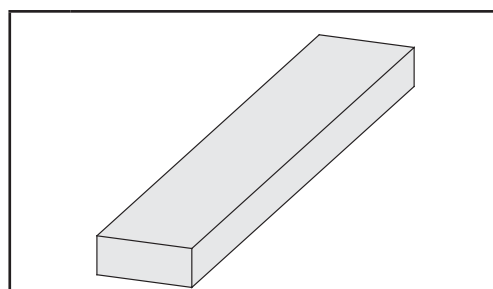

18 x A1	2950 x 121 x 28 mm	ID 29476
---------	--------------------	----------

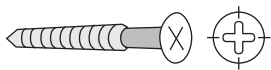





1 x Z1	2100 x 95 x 18 mm	ID 11427
1 x Z2	2100 x 120 x 18 mm	ID 65102
3 x Z3	2100 x 45 x 45 mm	ID 59046
1 x Z4	3090 x 60 x 40 mm	ID 28694

		
30 x	4 x 30 mm	ID 3686
140 x	4 x 50 mm	ID 3688
20 x	4 x 70 mm	ID 3689



*

 Nicht im Lieferumfang enthalten
 Not included
 Non comprises dans la livraison
 Niet bijgeleverd

 No forman parte del suministro
 Non incluso
 V ceně není zahrnuto
 Ikke inkluderet

 Übersicht
 Overview
 enquête

 overzicht
 undersøgelse
 estudio

 sondaggio
 přehled

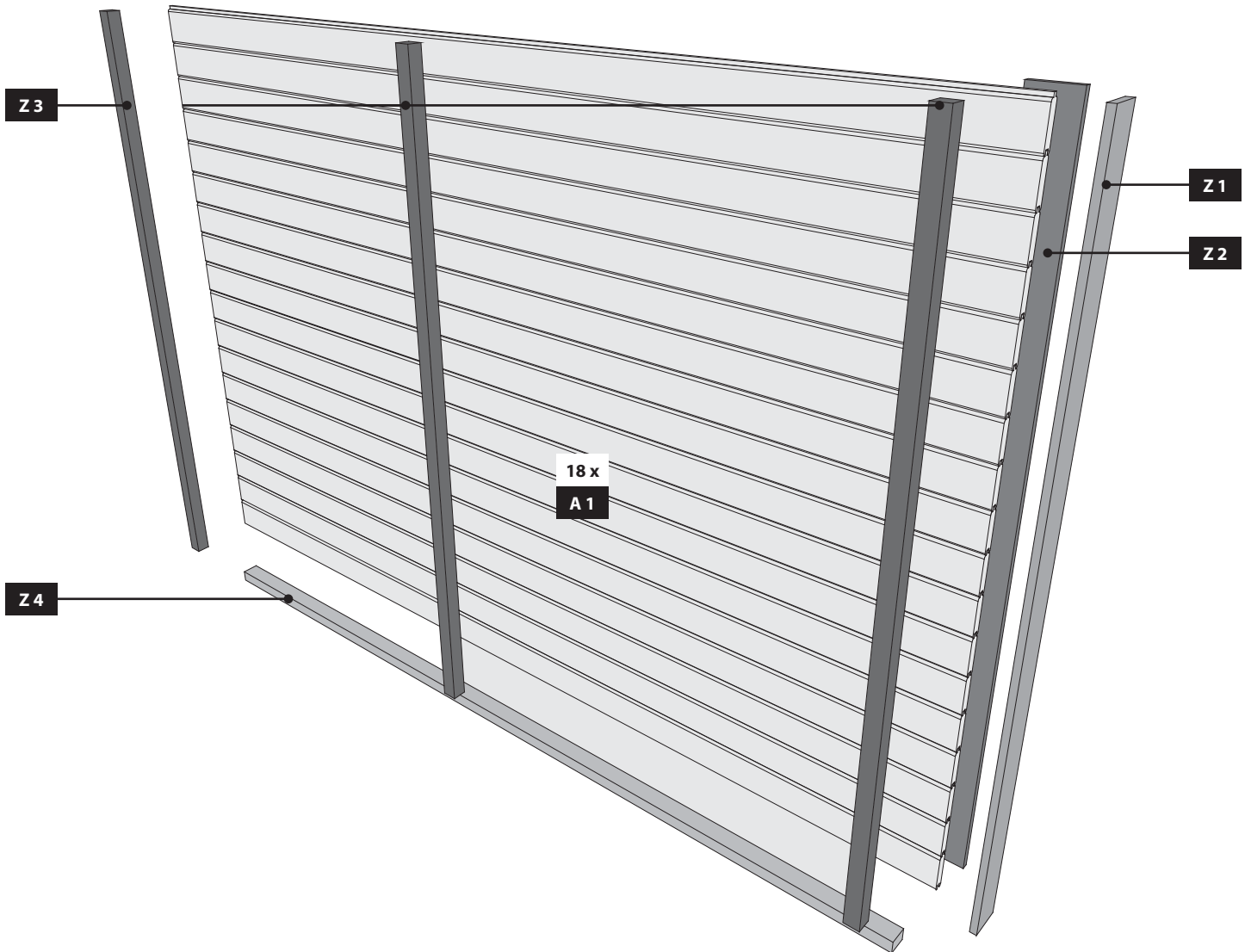

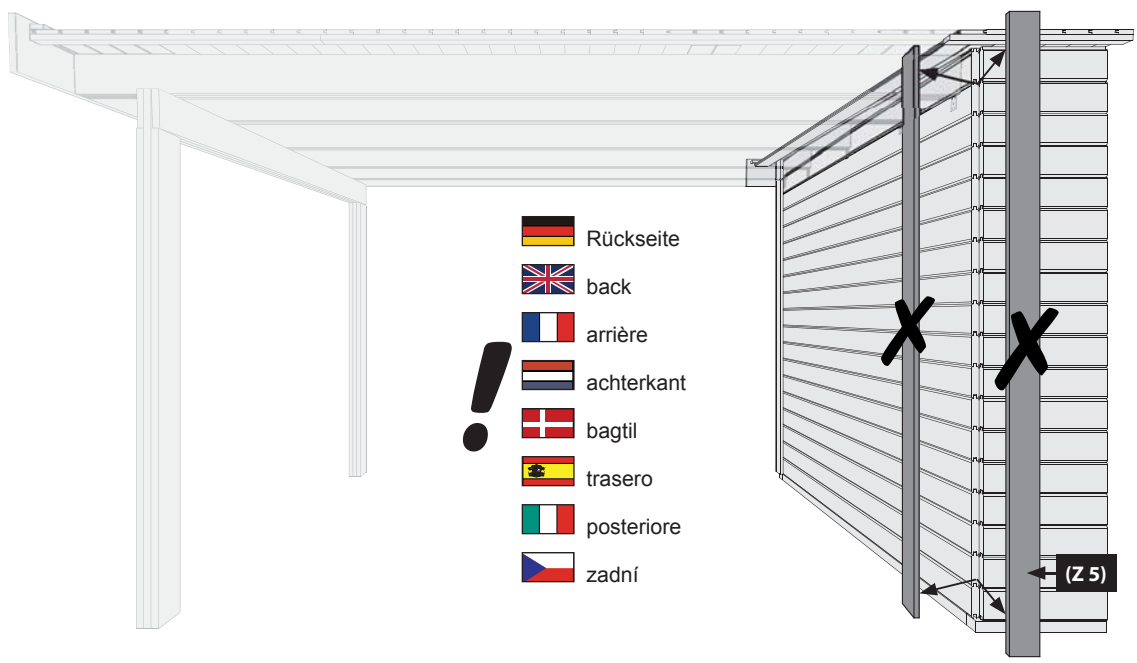

- * Länge muss ermittelt und zugesägt werden
- Length must be determined and sawn
- La longueur doit être déterminée et sciée
- De lengte moet worden bepaald en worden gezaagd
- La longitud debe ser determinada y aserrada
- La lunghezza deve essere determinata e segata
- Délka musí být určena a rozřezána
- Længden skal bestemmes og saves

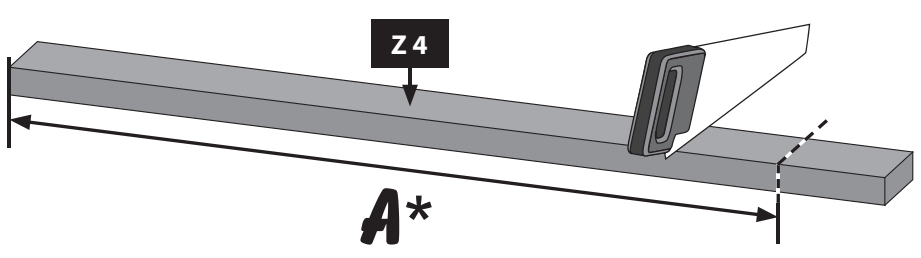
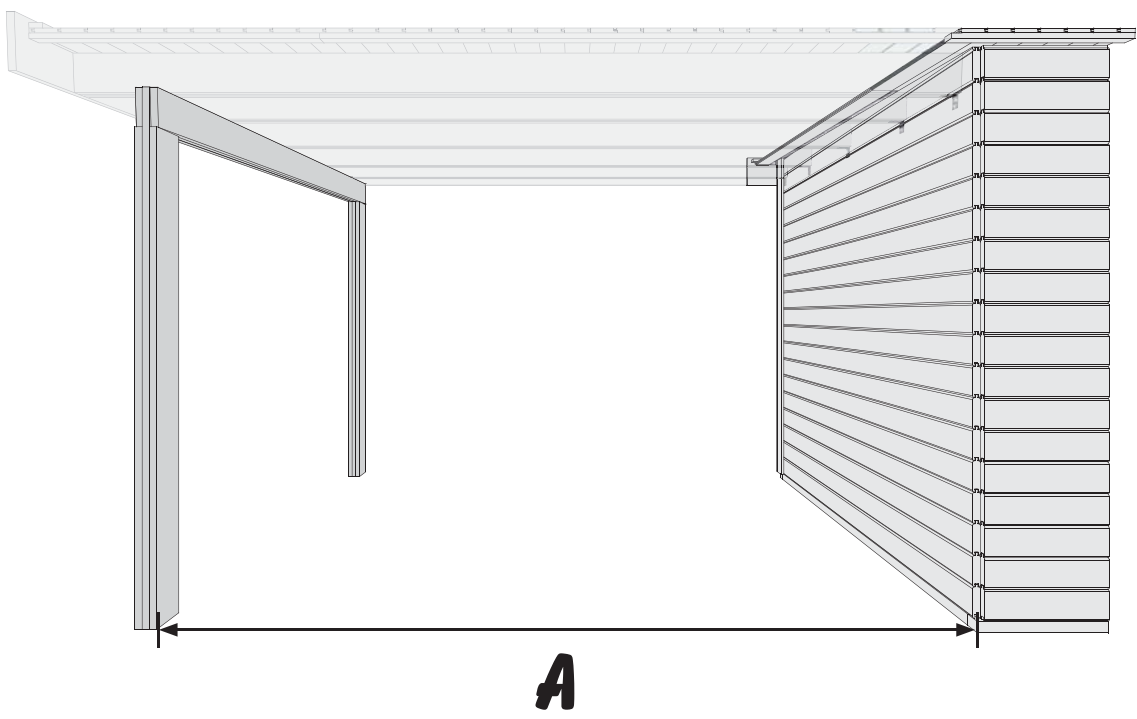
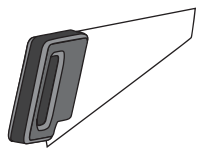
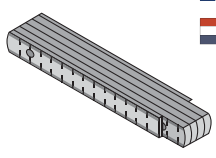

03

Ø3 mm 4x70

4x

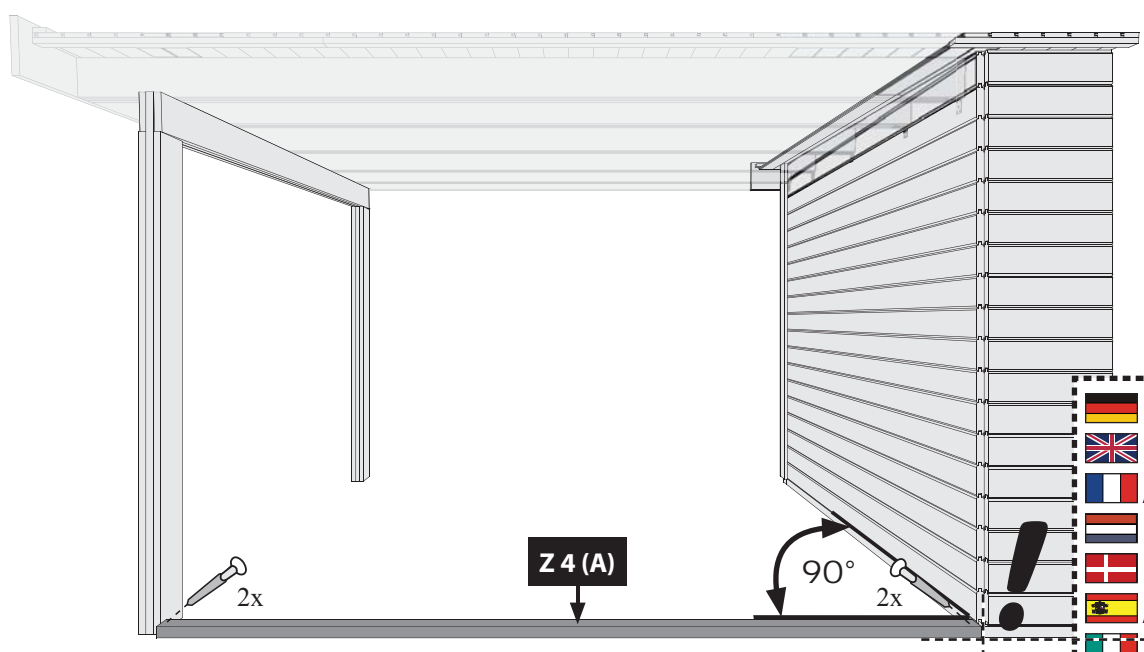

-  Bündig!
-  Flush!
-  Affleurement!
-  Gelijk!
-  I flugt!
-  Aras!
-  Combacia!
-  Stejný!

04

Ø3 mm 4x50

12x

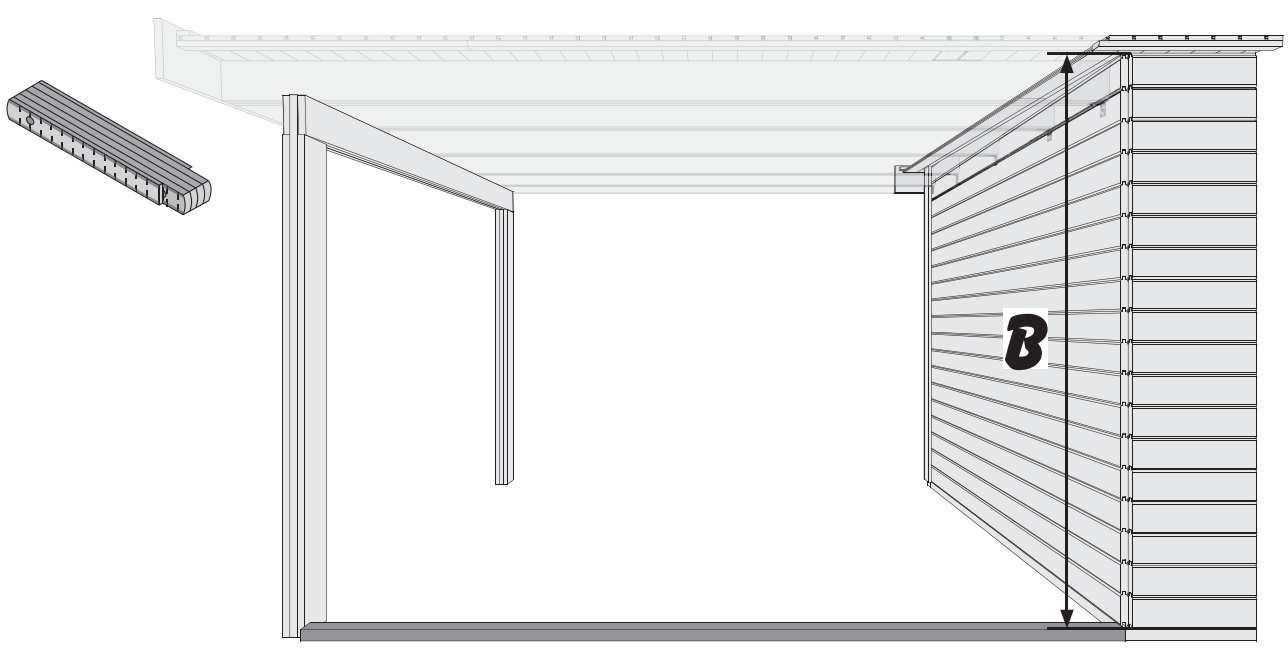

2x

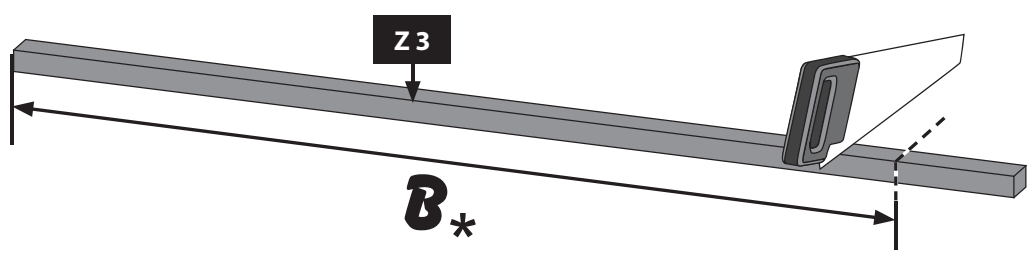

05

Ø3 mm 4x50

12x



05.1

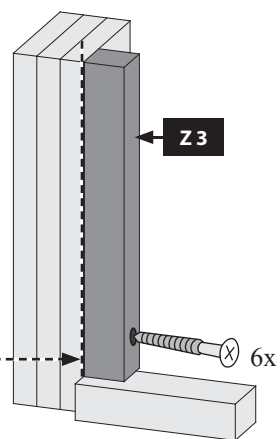
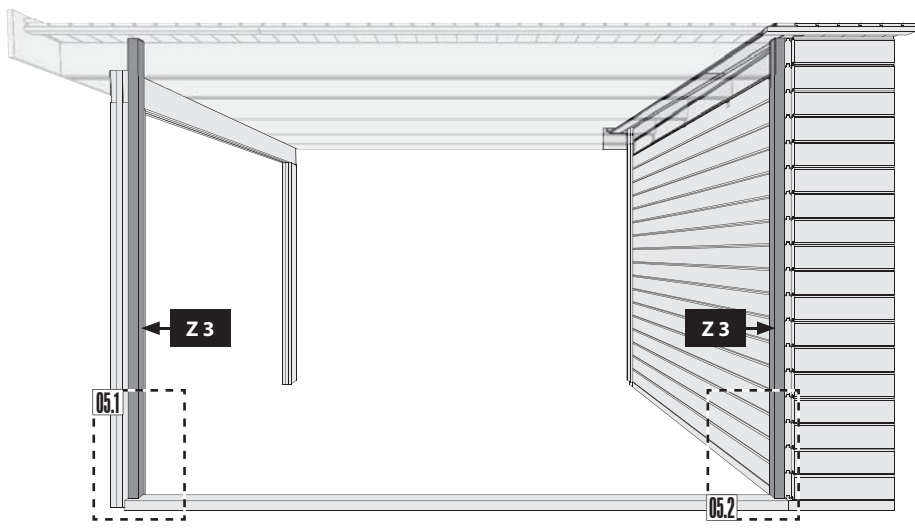

-  Bündig!
-  Flush!
-  Affleurement!
-  Gelijk!
-  I flugt!
-  Aras!
-  Combacia!
-  Stejný!

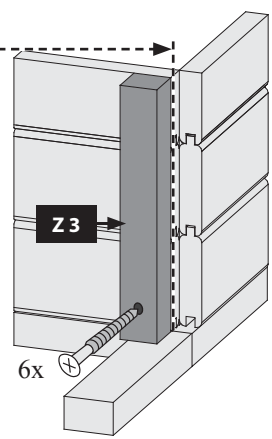

05.2

06

Ø3 mm 4x50

68x



06.1

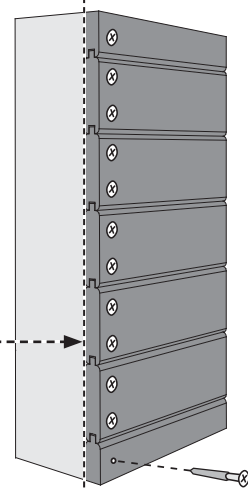
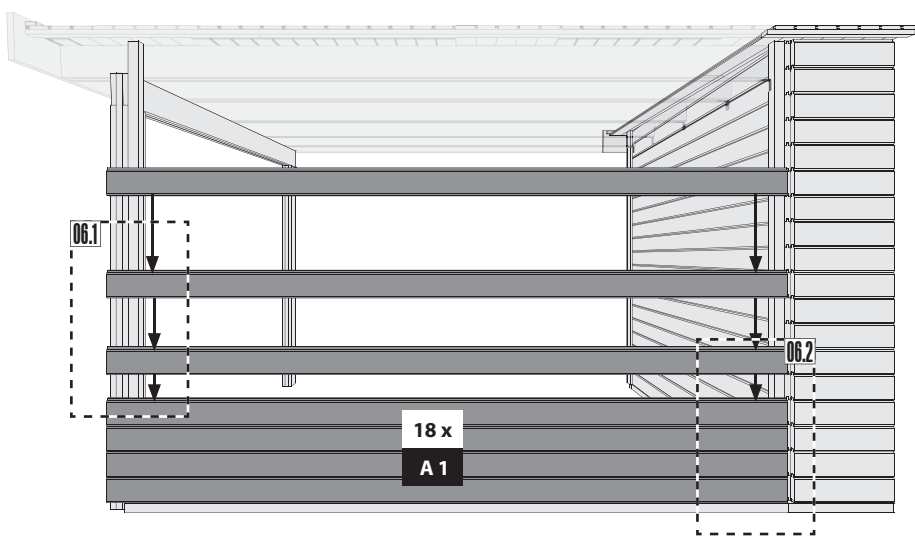

-  Bündig!
-  Flush!
-  Affleurement!
-  Gelijk!
-  I flugt!
-  Aras!
-  Combacia!
-  Stejný!

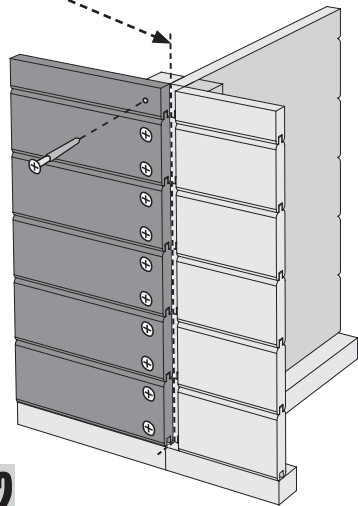

06.2

07

Ø3 mm 4x50

4x

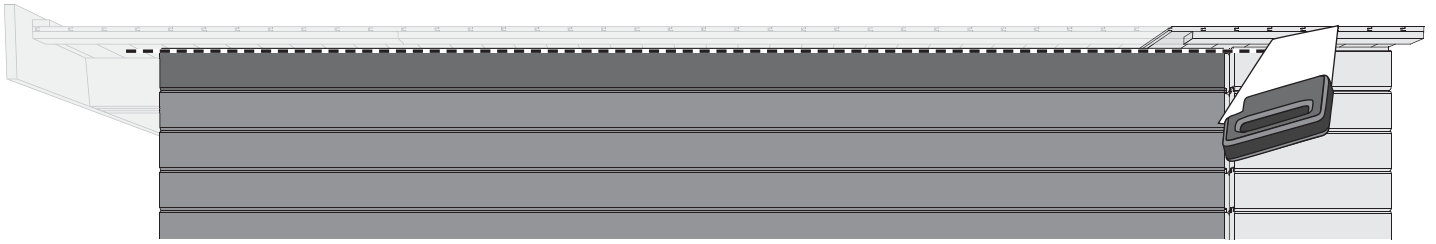
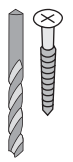

08

C



Z2

C

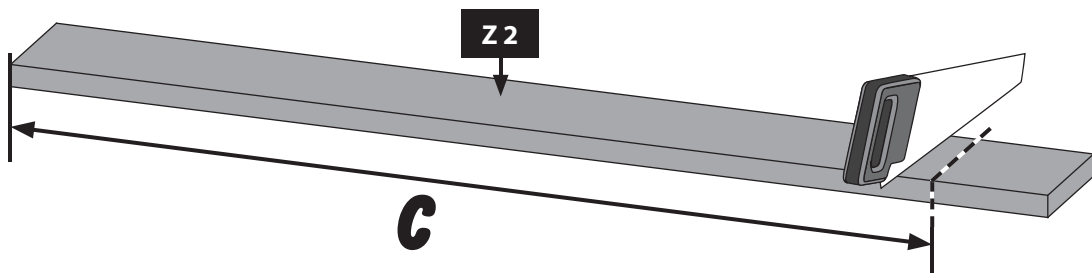

Ø3 mm 4x30

10x



-  Bündig!
-  Flush!
-  Affleurement!
-  Gelijk!
-  I flugt!
-  Aras!
-  Combacia!
-  Stejný !

Ø3 mm 4x30

20x

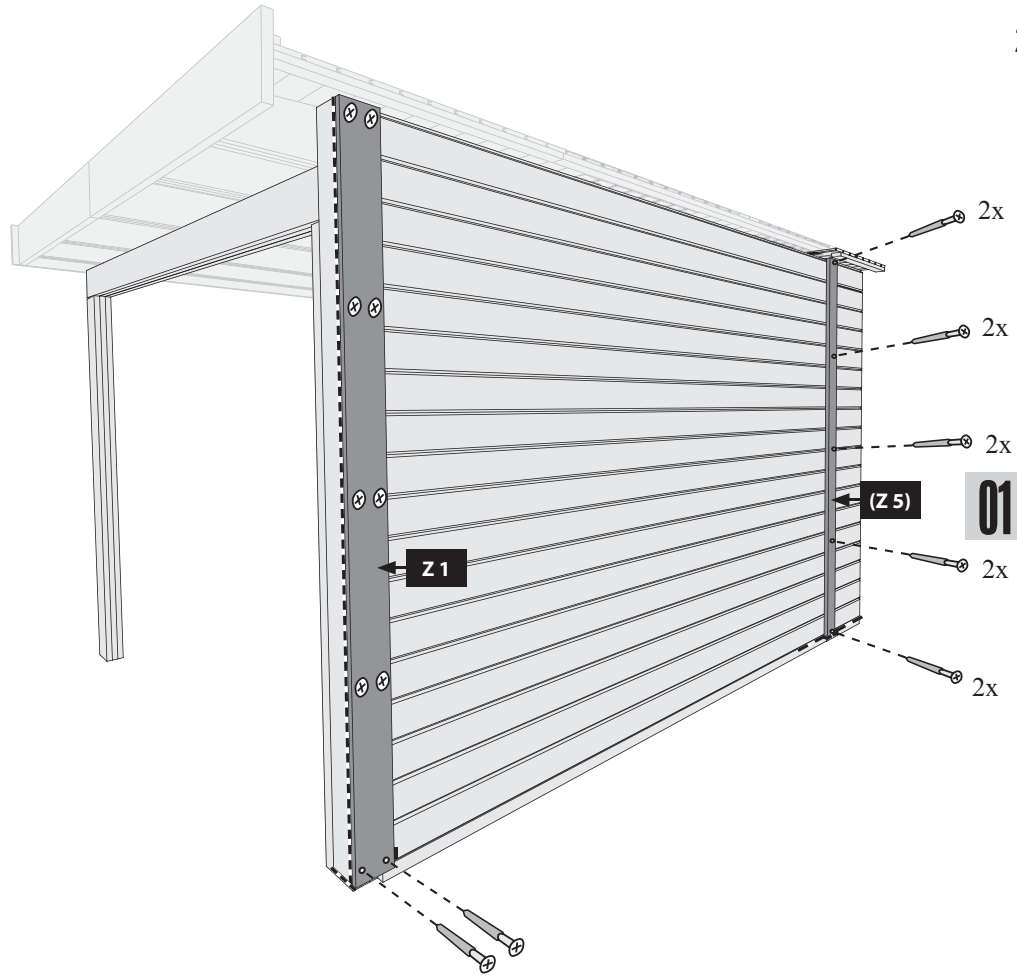

-  Bündig!
-  Flush!
-  Affleurement!
-  Gelijk!
-  I flugt!
-  Aras!
-  Combacia!
-  Stejný !

Ø3 mm 4x50

36x

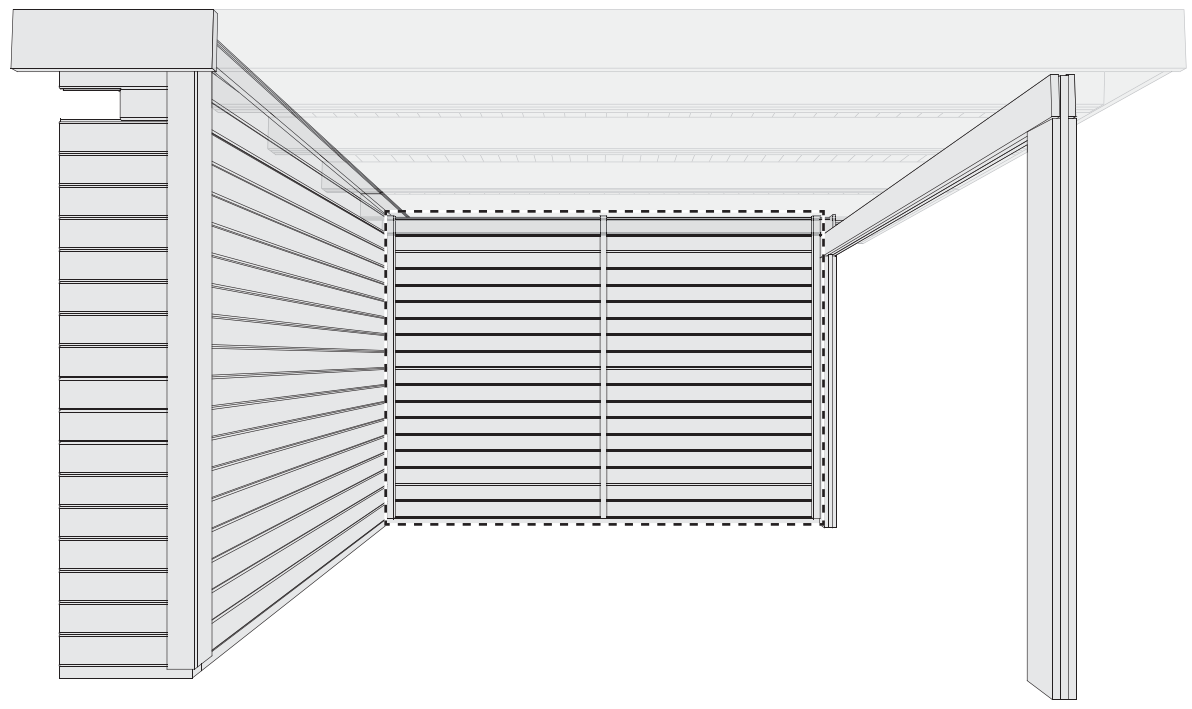

Z3

