

F30310

Bedienungsanleitung

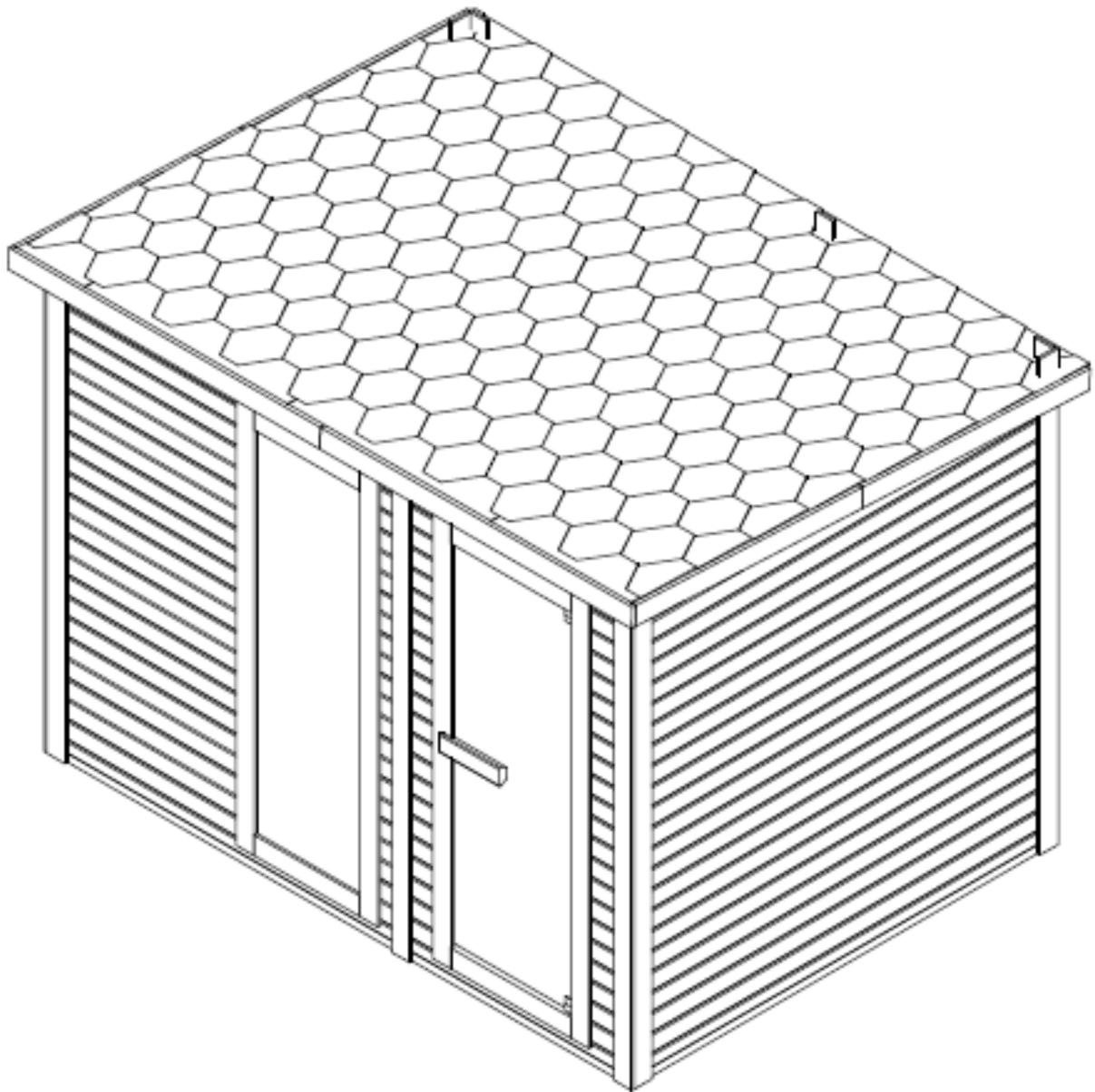

ACHTUNG

Lesen Sie diese Anleitung sorgfältig durch, bevor Sie Ihre Sauna zum ersten Mal in Betrieb nehmen.

Wir empfehlen Ihnen, es an einem sicheren Ort aufzubewahren, damit Sie es in Zukunft wieder verwenden können.

Bitte notieren Sie sich die Seriennummer des Schaltkastens der Kabine, da diese Nummer im Falle einer Reparatur oder Ersatzteilbestellung benötigt wird.

- Holz ist ein lebendiges Element. Um sein ursprüngliches Aussehen zu erhalten, ist es wichtig, die Außenseite des Holzes gegen Feuchtigkeit zu behandeln.
- Stellen Sie die Sauna auf eine vollkommen ebene und harte Fläche.
- Verwenden Sie keine flüssigen Reinigungsmittel. Schalten Sie die Sauna vor der Reinigung aus und verwenden Sie einen feuchten Lappen.
- Schützen Sie das Stromkabel der Sauna, damit es nicht gequetscht oder eingeklemmt wird.
- Vergewissern Sie sich vor dem Austausch bestimmter Bauteile, dass diese vom Hersteller vorgeschrieben sind oder die gleichen Eigenschaften wie die Originalteile haben. Ein falscher Austausch kann einen Brand, einen Kurzschluss oder eine Beschädigung der Sauna verursachen. Wir empfehlen dringend, einen qualifizierten Techniker hinzuzuziehen.
- Um das Risiko von Verbrennungen oder elektrischen Schlägen zu vermeiden, verwenden Sie keine Metallwerkzeuge.
- Tiere dürfen nicht in die Sauna gebracht werden.
- Lassen Sie die Sauna nicht unbeaufsichtigt eingeschaltet.
- Lassen Sie die Sauna nicht länger als 1 Stunde am Stück eingeschaltet, um eine vorzeitige Beschädigung des Geräts zu vermeiden. Schalten Sie die Sauna nach 1 Stunde Dauerbetrieb mindestens 30 Minuten lang aus.
- Es wird empfohlen, kein Schließsystem an der Sauna Tür zu installieren.
- Prüfen Sie vor dem Anschluss der Sauna an das Stromnetz, ob Ihre Elektroinstallation den Anforderungen entspricht.
- Installation und Reparaturen dürfen nur von einer Elektrofachkraft durchgeführt werden!
- Verwenden Sie nur Originalteile.
- Schalten Sie die Sauna bei Nichtgebrauch aus.

GEFAHR

- Das Abdecken der Öfen führt zu Brandgefahr durch Überhitzung. Decken Sie die Heizelemente nicht ab!
- Halten Sie brennbare oder leicht entflammbare Materialien/Gegenstände (z.B. Handtücher) stets vom Saunaofen fern.
- Berühren Sie das Heizgerät während und kurz nach der Benutzung nicht, da Verbrennungsgefahr durch die heißen Teile besteht.
- Die Glühbirne erwärmt sich während des Betriebs. Wenn die Glühbirne gewechselt werden muss, ziehen Sie den Stecker aus der Kabine und lassen Sie die Glühbirne abkühlen
- abkühlen, bevor Sie sie auswechseln.

Sicherheit

WICHTIG!

Bitte lesen Sie die Sicherheitshinweise sorgfältig durch, bevor Sie Ihre Saunakabine aufstellen und benutzen.
Die Hinweise sind wichtig für Ihre Sicherheit, also halten Sie sich bitte strikt an sie ein.

Achten Sie auf Hyperthermie, Hitzschlag oder Hitzeerschöpfung, die durch Nichtbeachtung der Sicherheitshinweise verursacht oder verschlimmert werden können. Die Symptome sind Fieber, schneller Puls, Schwindel, Ohnmacht, Lethargie und Taubheitsgefühl im ganzen Körper oder in Teilen des Körpers. Die Auswirkungen sind: verminderte Wahrnehmung der Hitze, Unkenntnis der drohenden Gefahren, Bewusstlosigkeit.

Die Sauna darf nicht benutzt werden von:

- Kinder unter 6 Jahren.
- Menschen mit starken Reaktionen auf Sonnenlicht.
- Personen mit Vorerkrankungen wie Herzkrankheiten, hohem oder niedrigem Blutdruck, Durchblutungsstörungen oder Diabetes ohne vorherige ärztliche Beratung.
- Schwangere Frauen. Überhöhte Temperatur kann den Fötus gefährden.
- Personen, die an Dehydrierung, offenen Wunden, Augenkrankheiten, Verbrennungen oder Sonnenstich leiden.

Kinder zwischen 6 und 16 Jahren dürfen die Sauna benutzen, sofern sie ständig von einem verantwortlichen Erwachsenen beaufsichtigt werden und die Temperatur 60°C nicht überschreitet.

Bei gesundheitlichen Problemen, Medikamenteneinnahme oder Verletzungen von Muskeln und Bändern dürfen Sie die Sauna nur nach vorheriger Rücksprache mit einem Arzt und dessen Genehmigung benutzen.

Wenn Sie chirurgische Implantate tragen, dürfen Sie die Sauna nicht benutzen, ohne vorher einen Arzt zu befragen und dessen Zustimmung einzuholen.

Benutzen Sie die Sauna nicht nach anstrengenden Aktivitäten.

Warten Sie 30 Minuten, bis sich Ihr Körper abgekühlt hat.

Verbringen Sie nicht mehr als 40 Minuten am Stück in der Sauna.

Nehmen Sie vor oder während der Sitzung keinen Alkohol oder Drogen zu sich.

Schlafen Sie nicht in der Sauna, wenn diese in Betrieb ist.

Um die Gefahr einer Überhitzung zu vermeiden, schließen Sie Ihre Sauna an eine ausreichend starke Steckdose an und schließen Sie keine anderen elektrischen Geräte an dieselbe Steckdose an.

Um das Risiko eines Stromschlags oder einer Beschädigung der Sauna zu vermeiden, darf diese nicht benutzt werden:

- Während eines Gewitters.
- Wenn das elektrische Kabel beschädigt ist, muss es von einer qualifizierten Person ersetzt werden.
- Bei Überhitzung des Stromkabels muss es von einer qualifizierten Person überprüft werden.
- Wenn Sie eine Glühbirne wechseln müssen, warten Sie, bis die Sauna ausgeschaltet und abgekühlt ist.

Trocknen Sie sich die Hände, bevor Sie den Strom anschließen oder abschalten.

Niemals mit nassen Händen oder Füßen arbeiten.

Schalten Sie den Strom oder die Heizung nicht schnell ein oder aus, da dies die elektrische Anlage beschädigen könnte.

Versuchen Sie nicht, die Sauna ohne Zustimmung des Saunahändlers oder des Herstellers selbst zu reparieren.

Unerlaubte Reparaturversuche führen zum Erlöschen der Herstellergarantie.

Verwenden Sie keine Reinigungsmittel in der Sauna.

Keine Gegenstände in oder auf der Sauna stapeln oder lagern.

Stellen Sie keine brennbaren Materialien oder chemische Stoffe in der Nähe der Sauna auf.

Decken Sie die Heizelemente nicht ab!





Berühren Sie das Heizgerät während und kurz nach der Benutzung nicht, da aufgrund der heißen Teile Verbrennungsgefahr besteht.



Schalten Sie die Kabine bei Nichtgebrauch aus.

Technische Daten:

Modell	F30310
Material der Kabine	Fichtenholz
Tiefe	2300mm
Breite	3100mm
Höhe	2200mm
Spannung	AC380V
Saunaofen	8KW

Montagematerial (Abweichungen möglich)

											
Ø3x16	Ø4x70	Ø4x60	Ø4x50	Ø4*40	Ø4*30	Ø4*18	Ø5*100	Ø6x60	Wood pad		
6x	103x	300x	76x	240x	62x	40x	2x	4x	2x	2x	4x

		
2x	10x	2x

Bitte entfernen Sie die Transportverpackung und überprüfen Sie, ob Ihre Infrarotkabine vollständig und unversehrt geliefert wurde, bevor Sie mit dem Zusammenbau beginnen.

Lesen Sie die Montageanleitung sorgfältig durch, bevor Sie einen geeigneten Platz für Ihre Sauna gefunden haben. Die Sauna ist ausschließlich nur für die Installation im Außenbereich entworfen.

Wählen Sie einen Bereich aus:

- An einem trockenen Ort auf einer ebenen, stabilen Oberfläche, die das Gewicht Ihrer Sauna tragen kann.
- Die Höhe muss ausreichend sein, damit Sie die Decke erreichen und elektrische Anschlüsse und Wartungsarbeiten durchführen können.
- Von Wasserquellen, Flammen oder brennbaren Materialien fernhalten.
- Die erforderliche Mindestraumhöhe beträgt 2,02 m

Praktische Ratschläge

- Bitte beachten Sie, dass für den Saunaaufbau min. 2 Erwachsene erforderlich sind.
- Identifizieren Sie jedes Panel eindeutig, bevor Sie beginnen
- Verlegen Sie bei der Montage das Netzkabel Ihrer Sauna so, dass es leicht zugänglich ist.
- Beachten Sie, dass es Unterschiede zwischen den Modellen gibt.

WICHTIG :





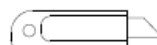
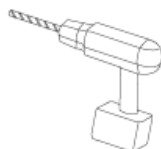
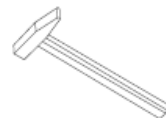
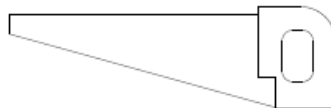
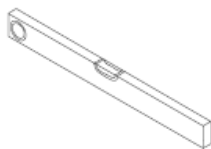



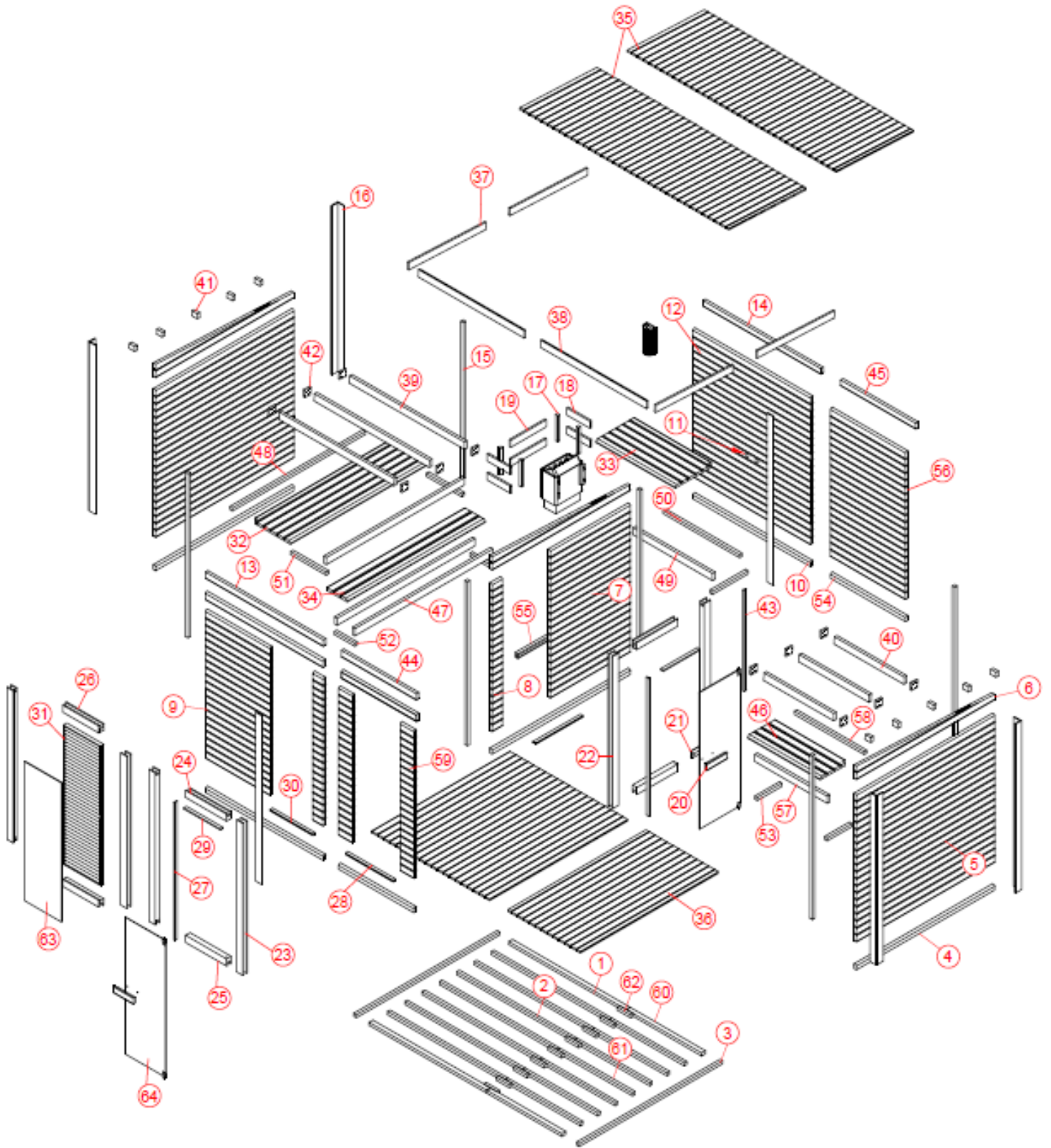

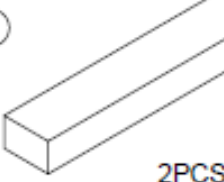
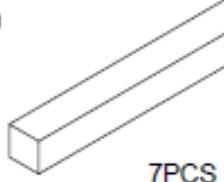
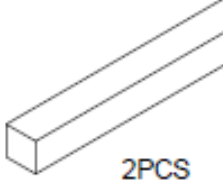
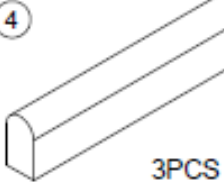
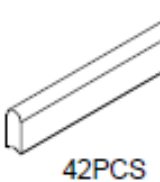

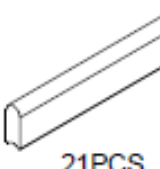

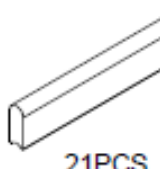
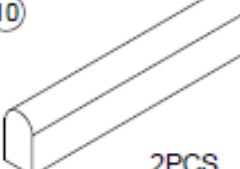
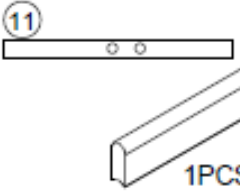
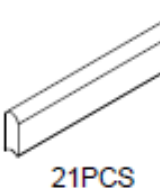
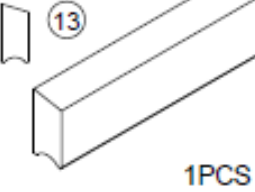
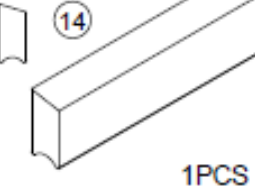
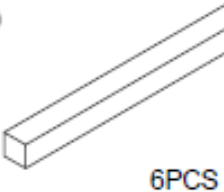
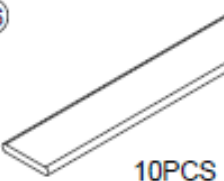
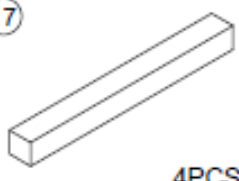
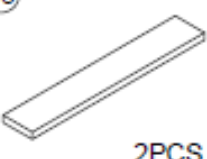
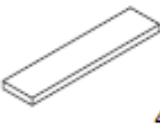

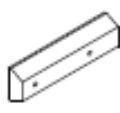
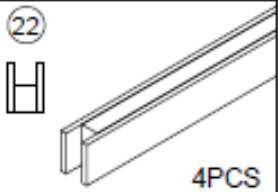
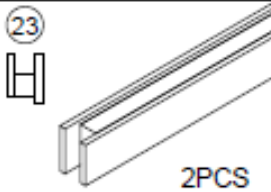
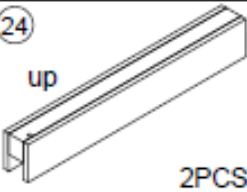

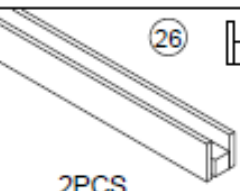
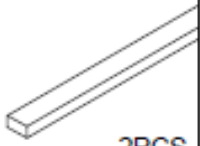
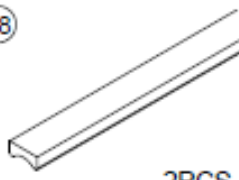
Bitte überprüfen Sie die Senkung und den Lochdurchmesser der Bohrlöcher, um eine Beschädigung des Holzes zu vermeiden.

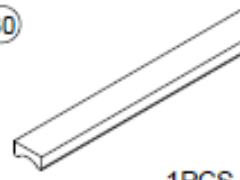

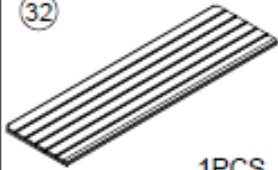
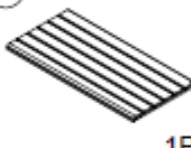

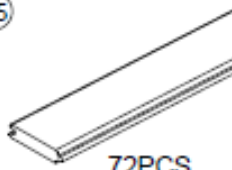



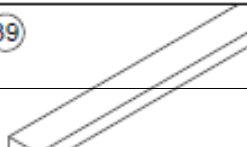
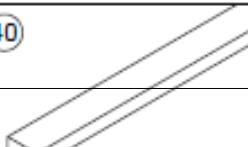

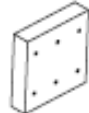

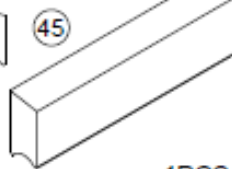
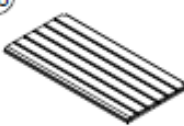

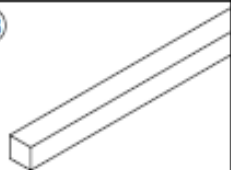

Werkzeuge:

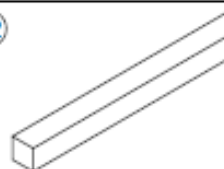

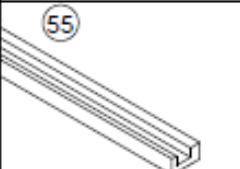
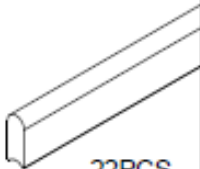
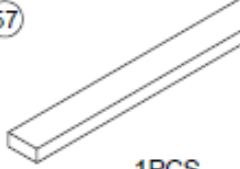
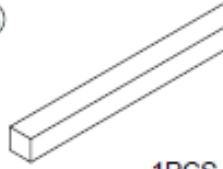
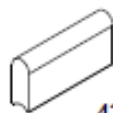
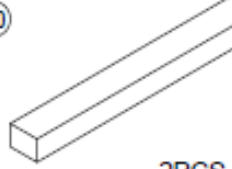
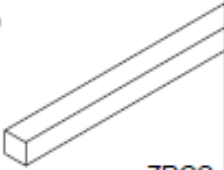
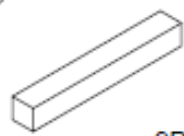
Stückliste:

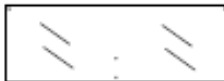

①  2PCS 1724*55*38mm	②  7PCS 1724*38*38mm	③  2PCS 2100*38*38mm	④  3PCS 2024*67*38mm	⑤  42PCS 2024*97*38mm
⑥  3PCS 2024*168*38mm	⑦  21PCS 1172*97*38mm	⑧  42PCS 150*97*38mm	⑨  21PCS 945*97*38mm	⑩  2PCS 1724*67*38mm
⑪  1PCS 1724*97*38mm	⑫  21PCS 1724*97*38mm	⑬  1PCS 1724*81*38mm	⑭  1PCS 1724*70*38mm	⑮  6PCS 2188*38*38mm
⑯  10PCS 2140*90*13mm	⑰  4PCS 330*33*33mm	⑱  2PCS 520*90*20mm	⑲  4PCS 340*90*20mm	⑳  1PCS 300*90*40mm
㉑  1PCS 252*90*40mm	㉒  4PCS 1927*90*66mm	㉓  2PCS 1927*90*66mm	㉔  2PCS 600*90*66mm	㉕  2PCS 600*90*66mm
㉖  2PCS 547*90*66mm	㉗  2PCS 1747*40*13mm	㉘  2PCS 700*38*17mm	㉙  2PCS 537*40*13mm	㉚  1PCS 627*38*17mm
㉛  1PCS 1765*545*47mm	㉜  1PCS 2022*560*33mm	㉝  1PCS 1162*560*33mm	㉞  1PCS 2022*300*33mm	㉟  72PCS 1130*97*18mm
㊳ 	㊴ 	㊵ 	㊶ 	㊷ 

 10PCS 80*60*38mm	 12PCS 90*90*20mm	 1PCS 1550*33*13mm	 1PCS 1100*81*38mm	 1PCS 1100*70*38mm
 1PCS 1060*400*33mm	 3PCS 2022*90*38mm	 1PCS 1946*38*38mm	 1PCS 1162*90*38mm	 1PCS 1124*38*38mm
 3PCS 522*38*38mm	 2PCS 300*38*38mm	 2PCS 362*38*38mm	 2PCS 1100*67*38mm	 1PCS 820*40*20mm
 22PCS 1100*97*38mm	 1PCS 1060*90*38mm	 1PCS 1022*38*38mm	 42PCS 198*97*38mm	 2PCS 1100*55*38mm
 7PCS 1100*38*38mm	 9PCS 200*38*38mm	 1PCS 1764*544*6mm	 1PCS 1733*594*6mm	 1PCS 300*142*105MM
 Sauna light	 Sauna stove	 69PCS 1000*320*5mm		

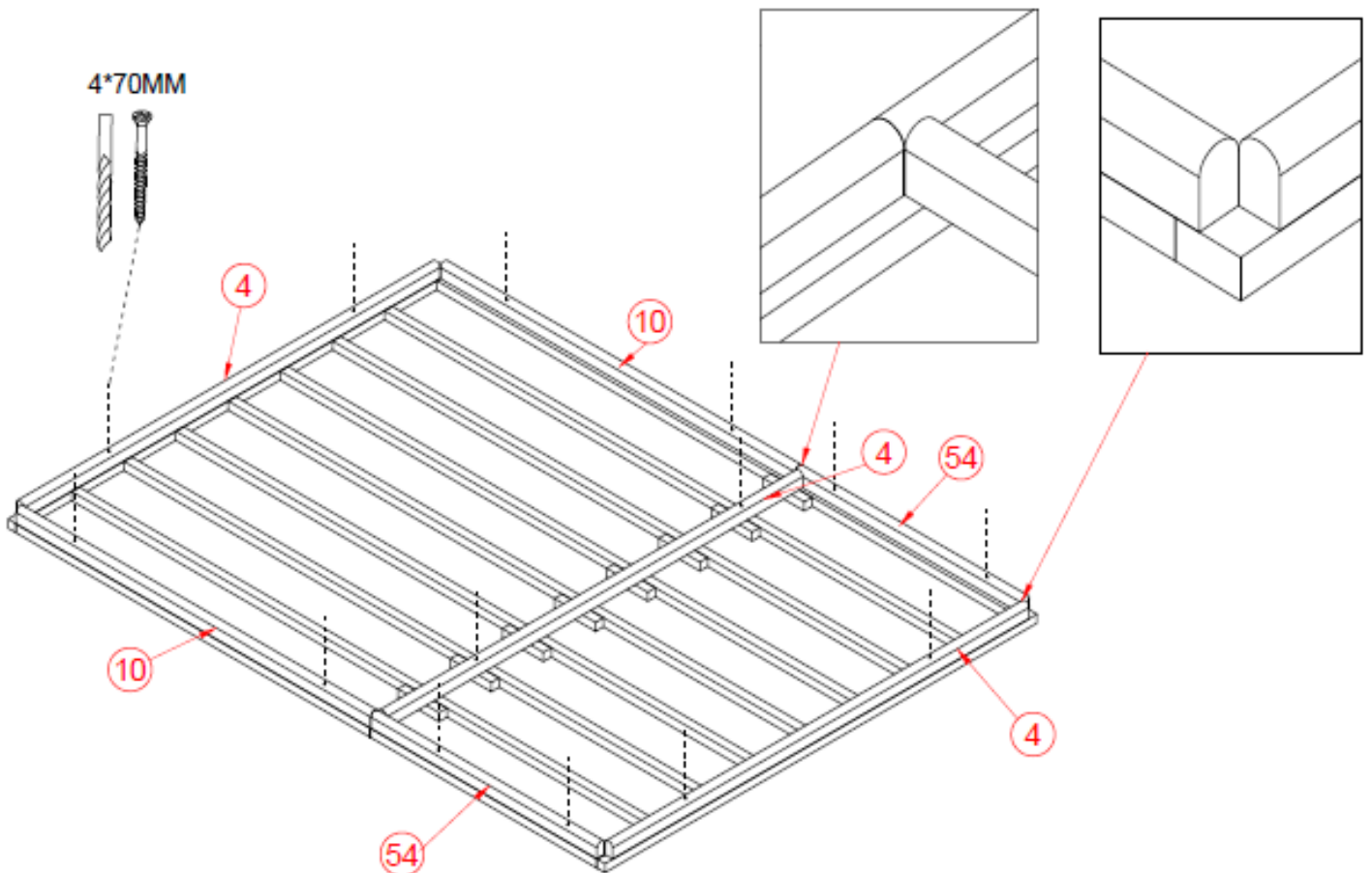
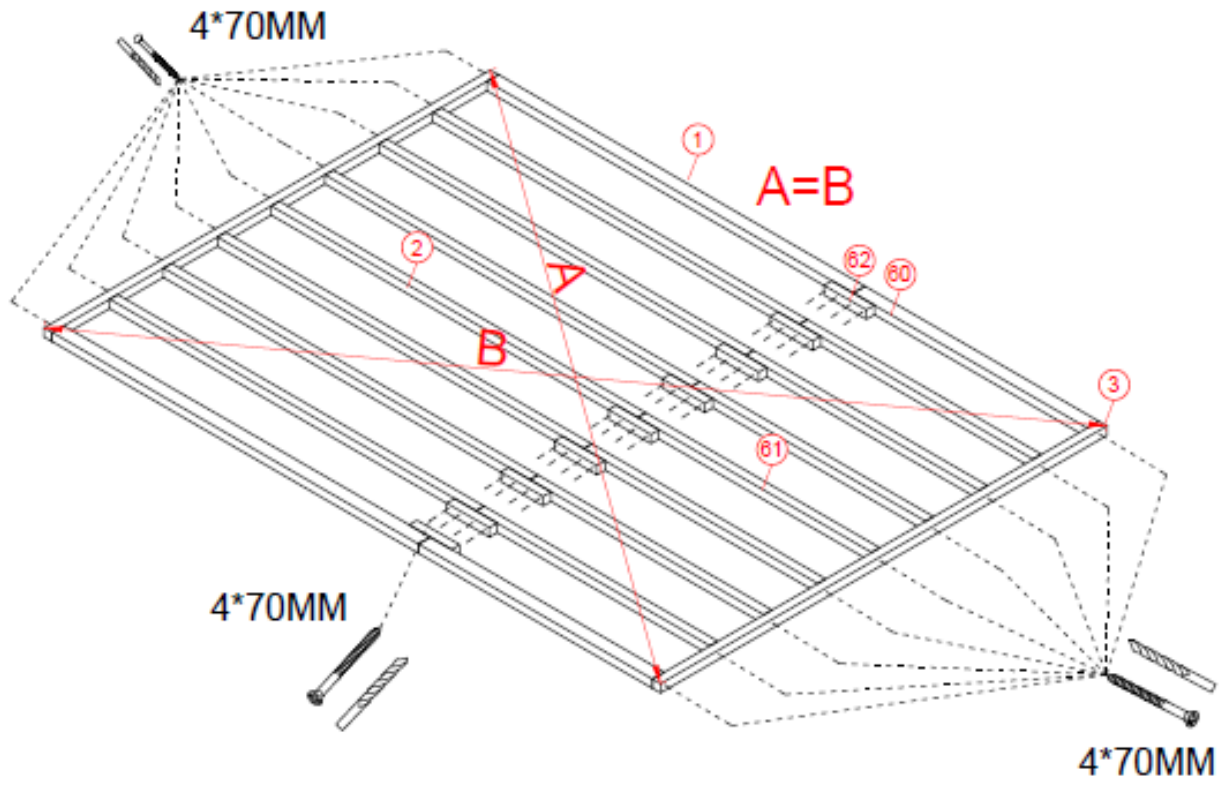

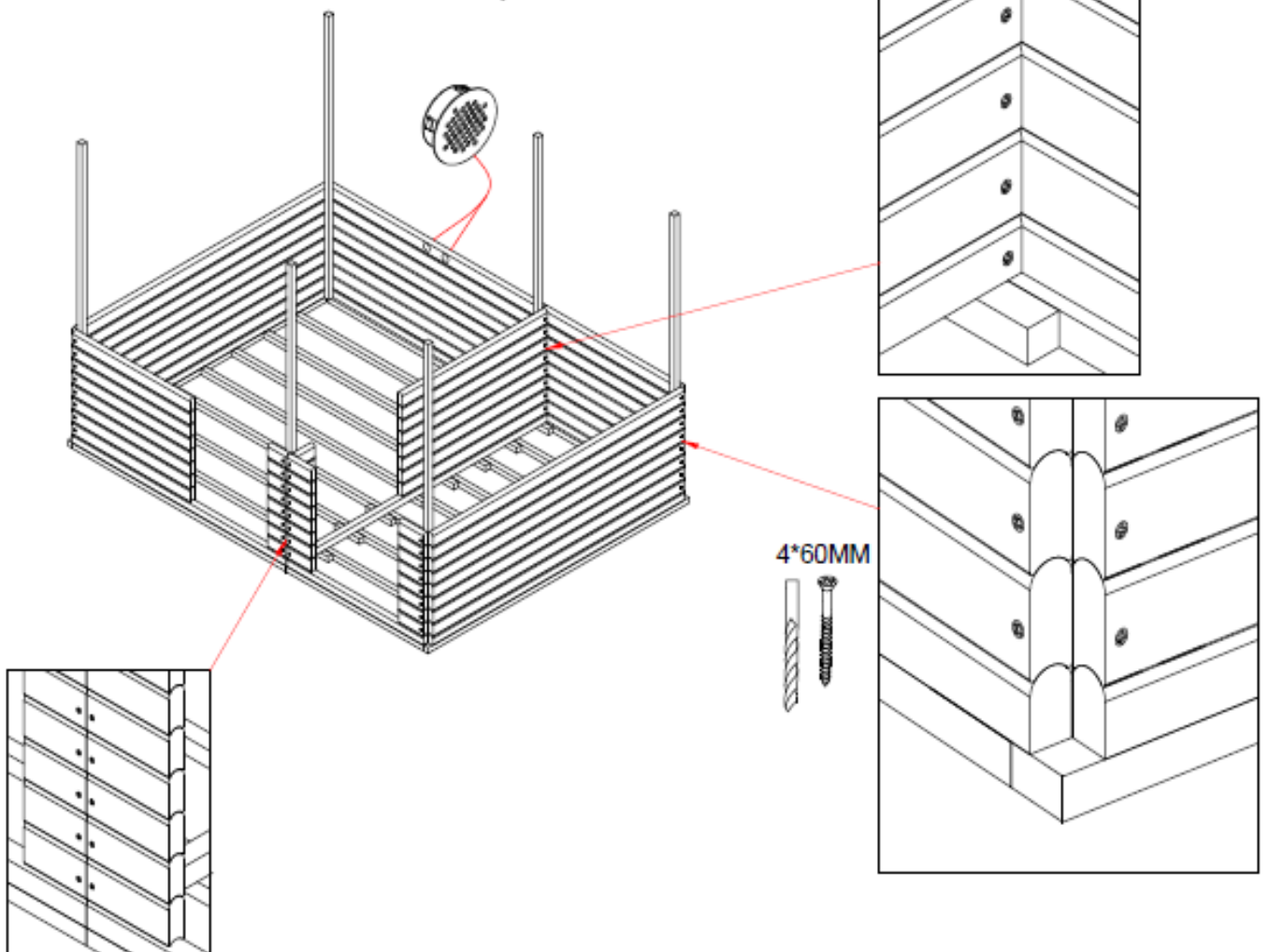
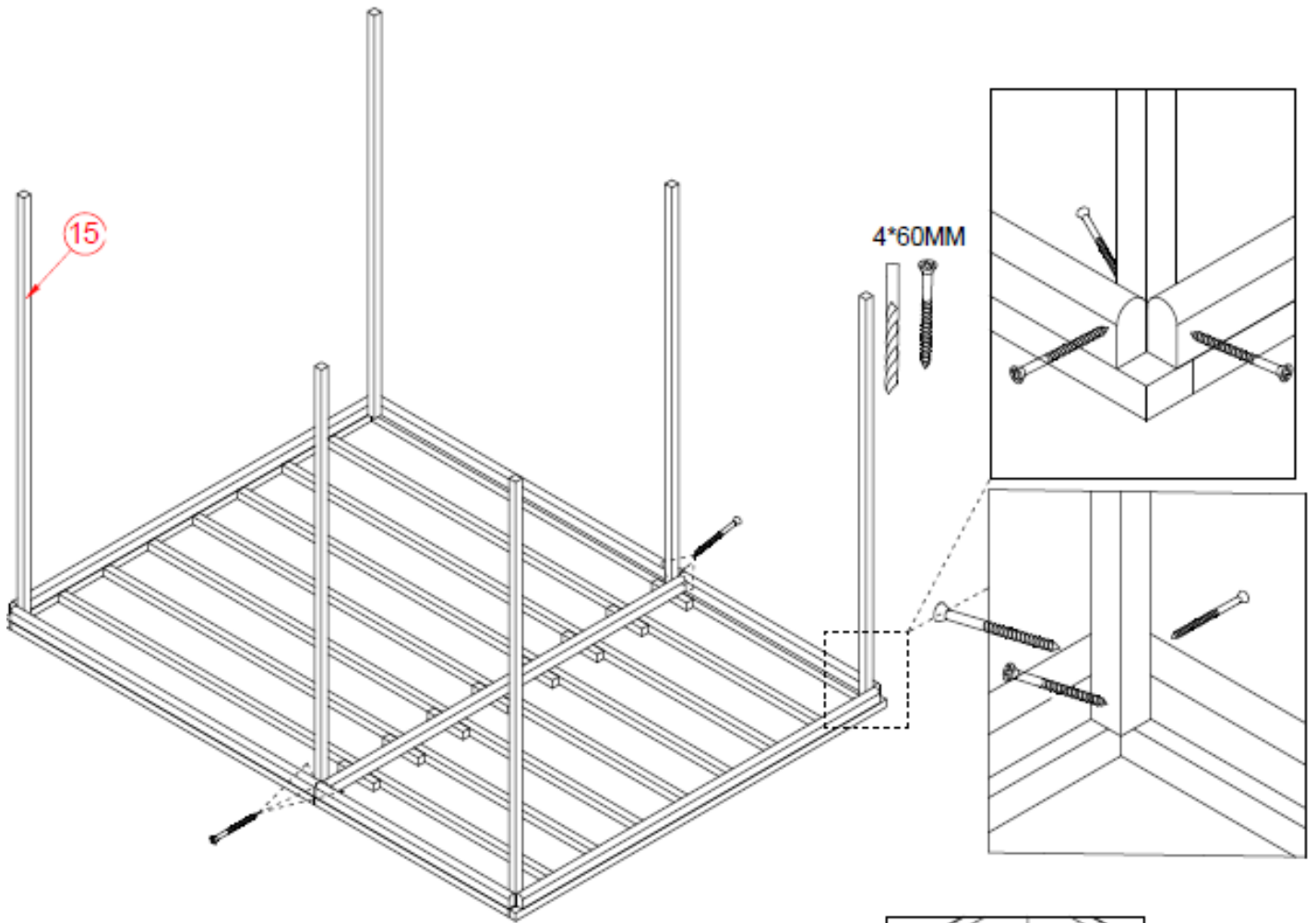

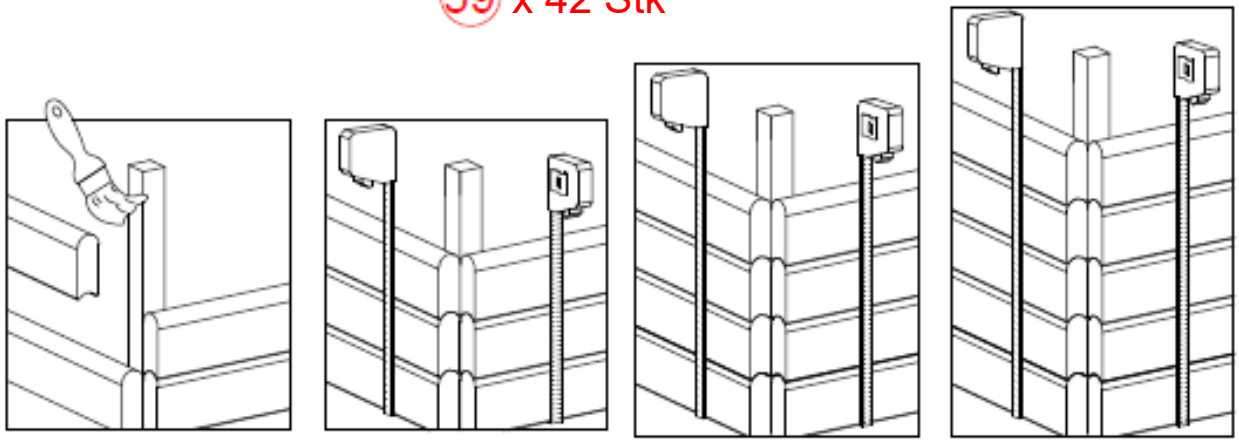
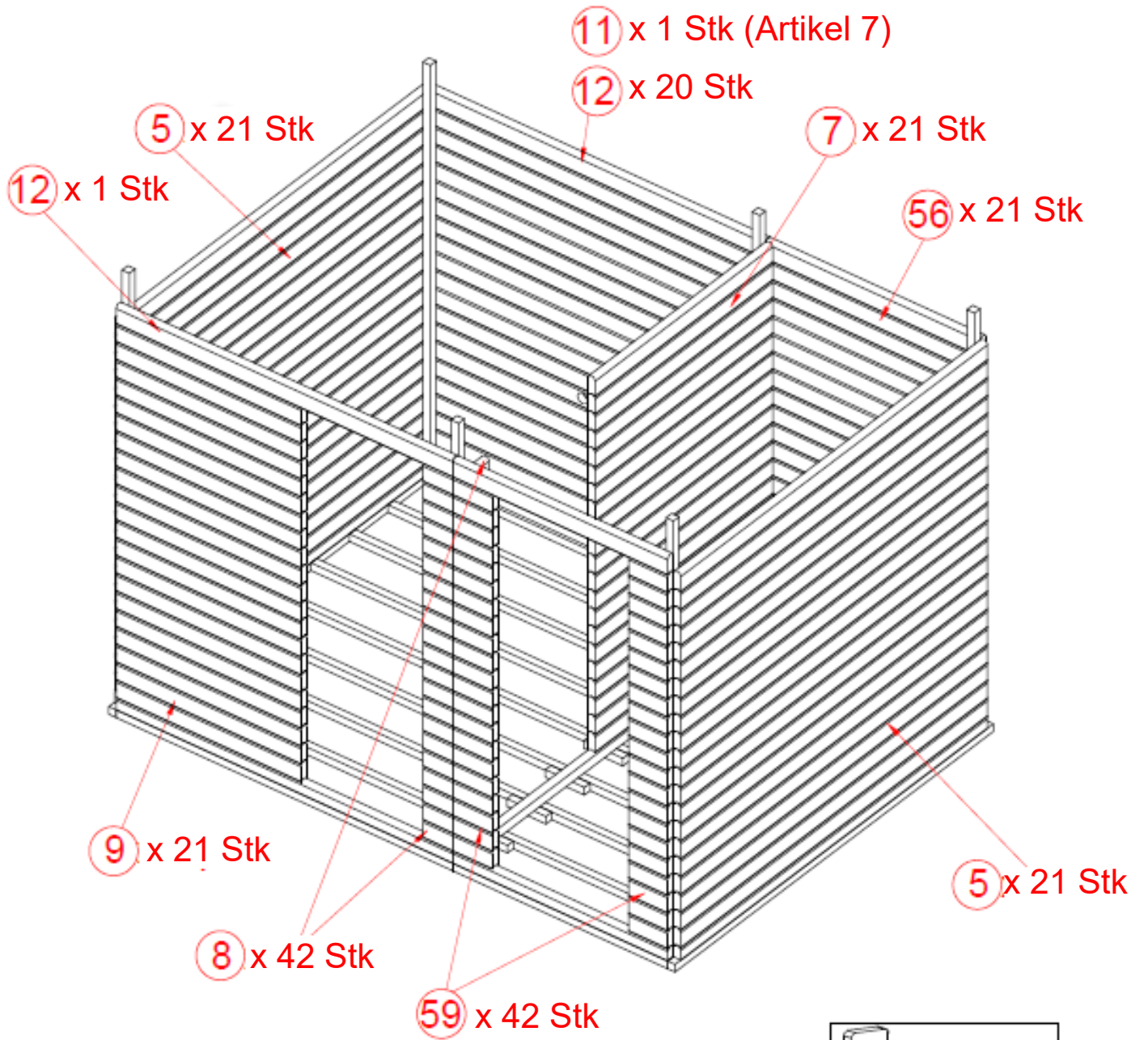

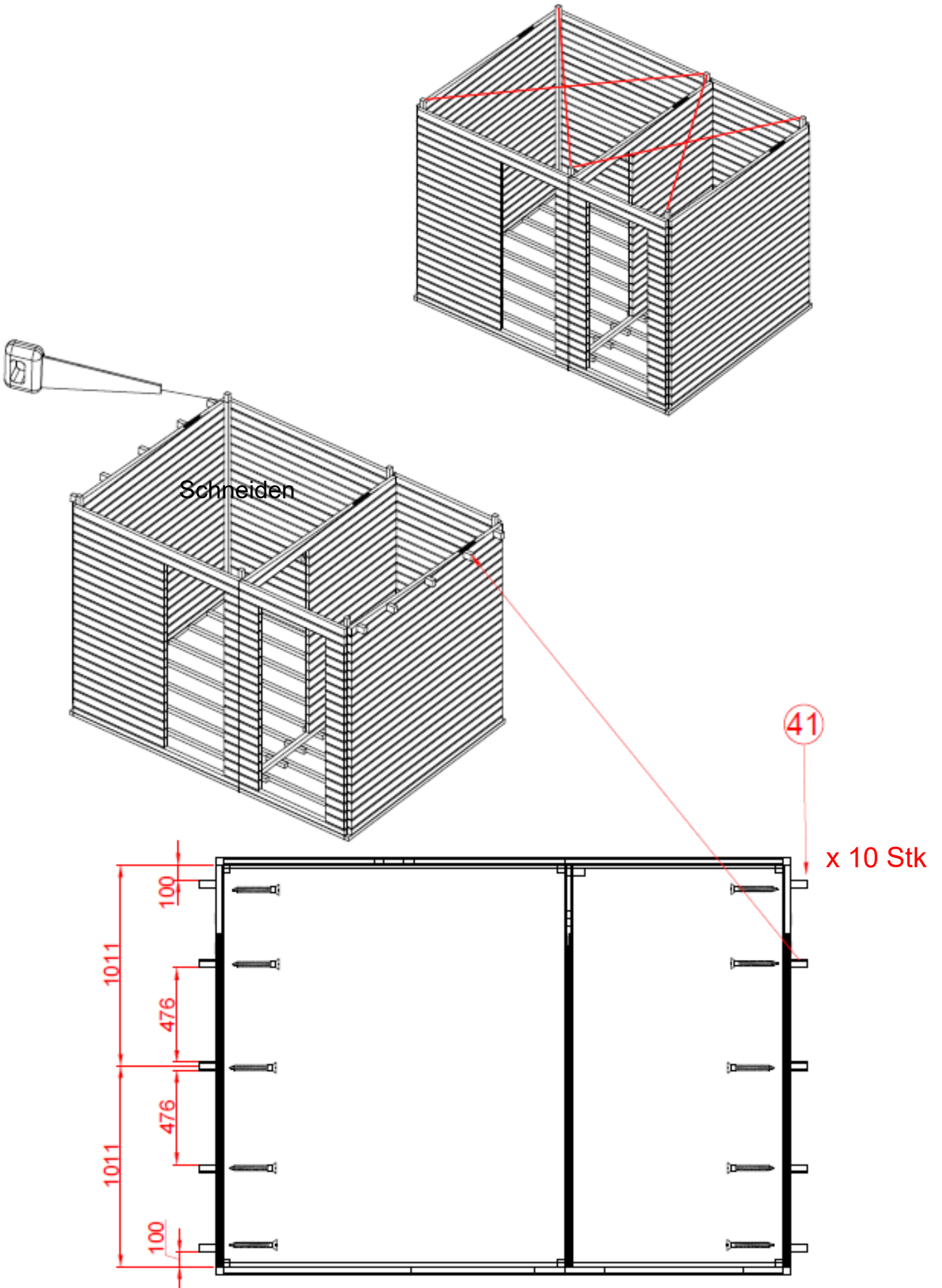

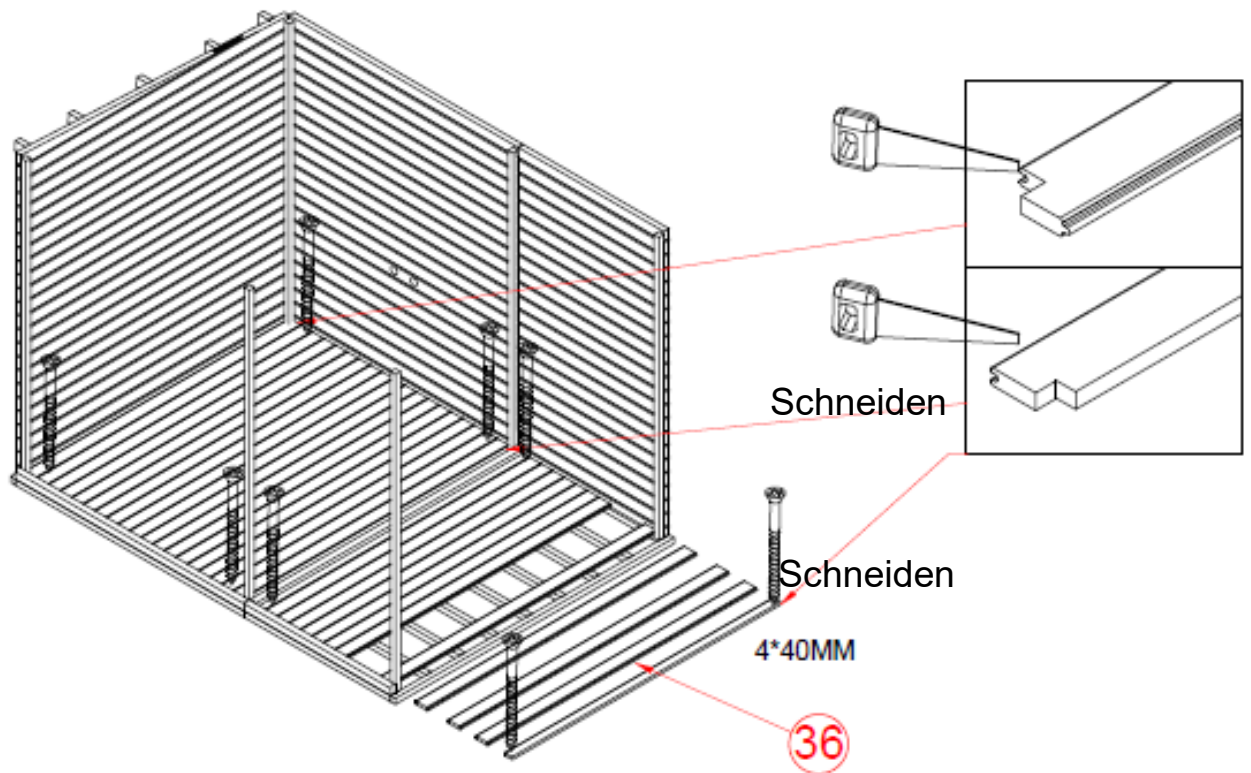
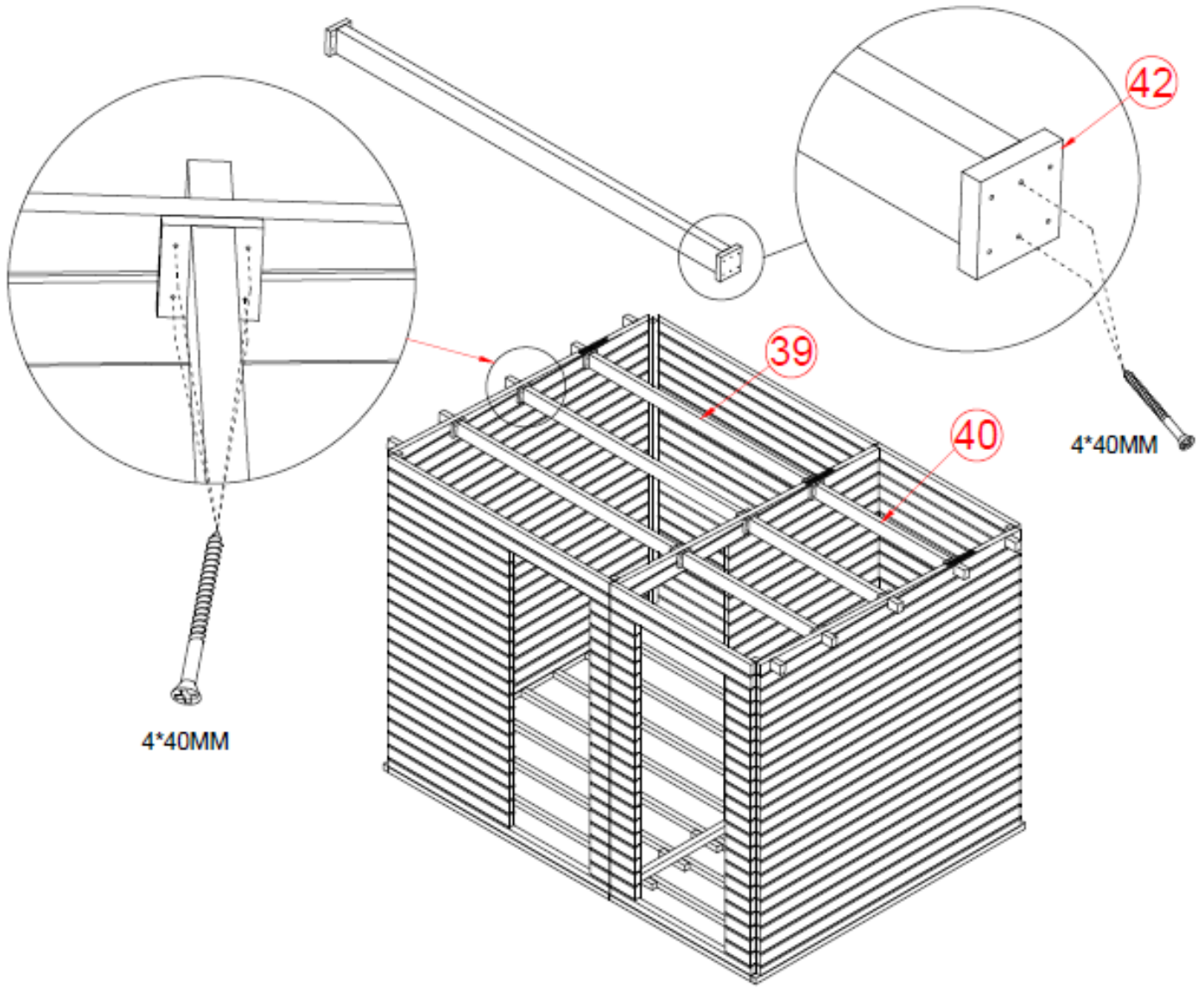

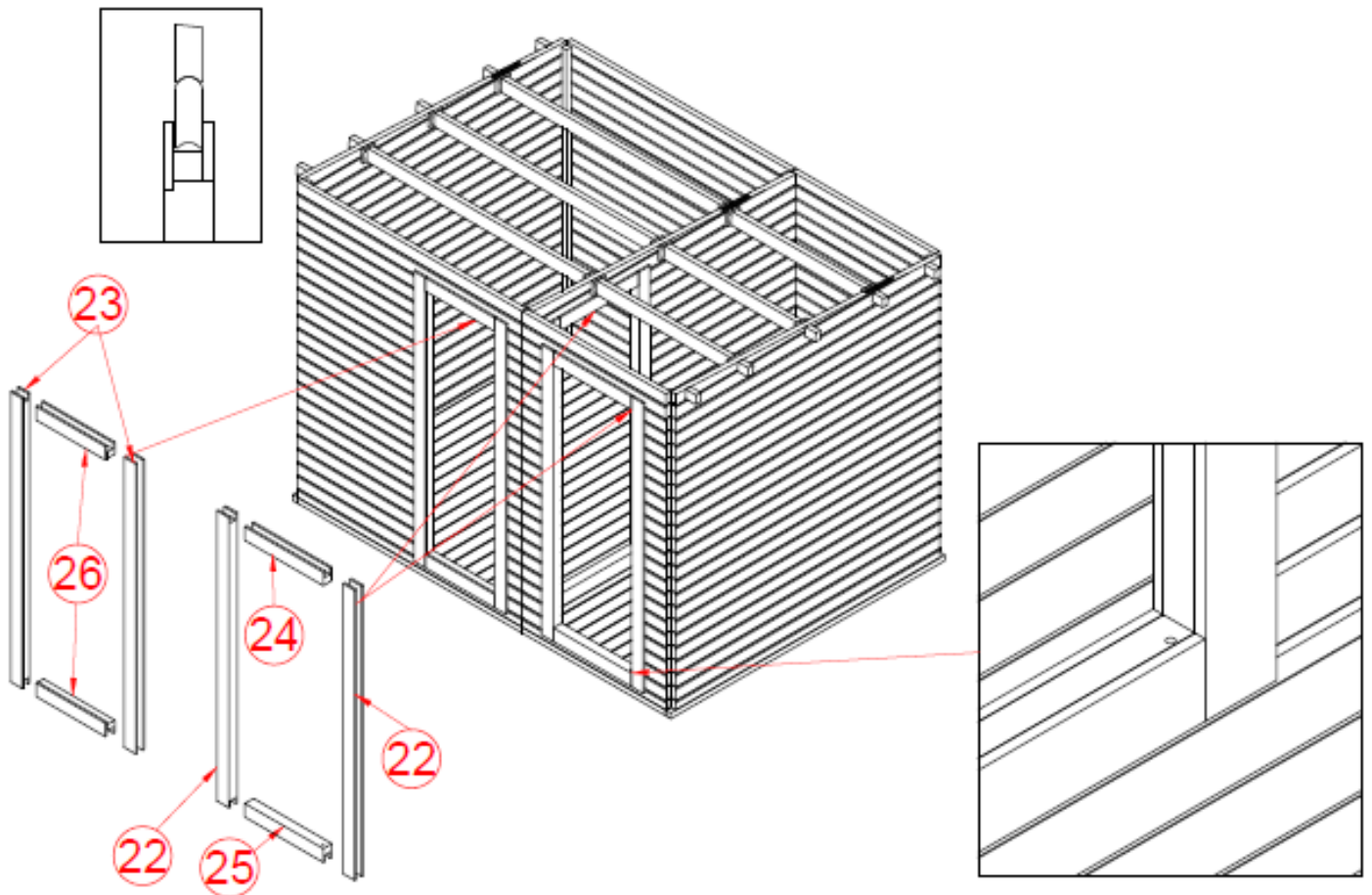
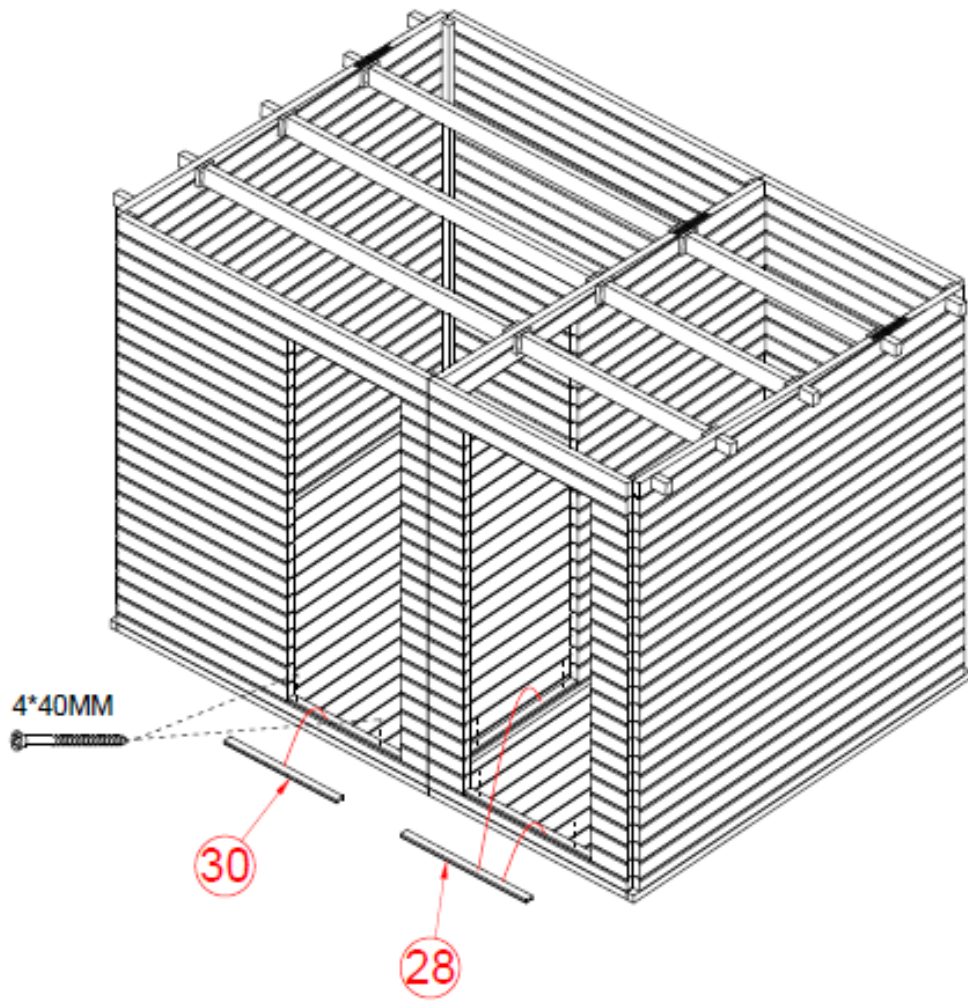

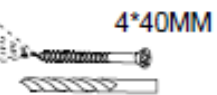
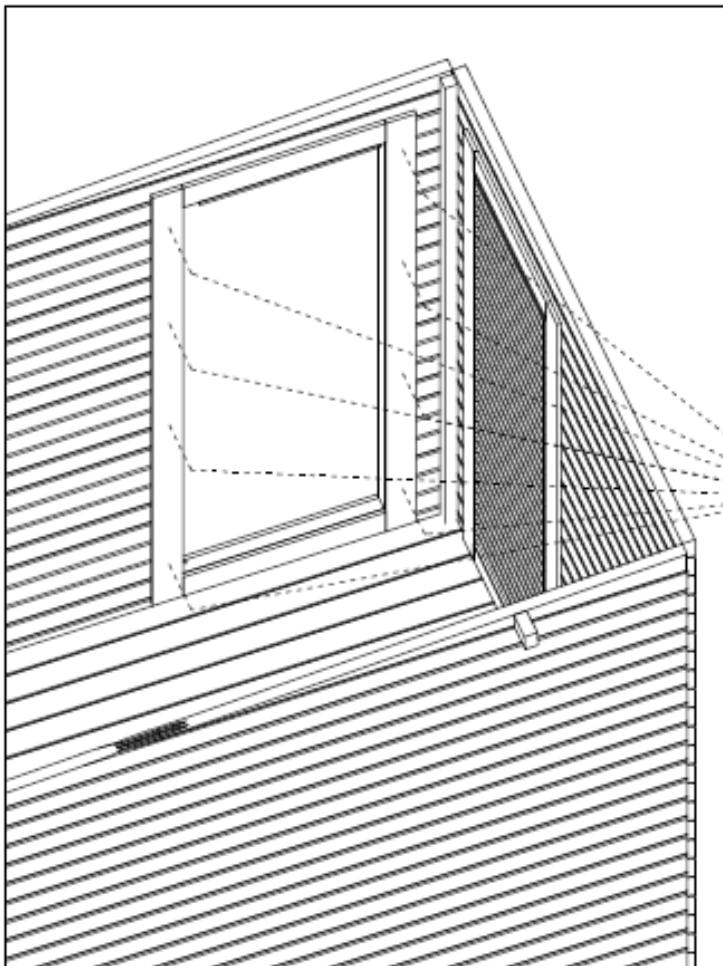
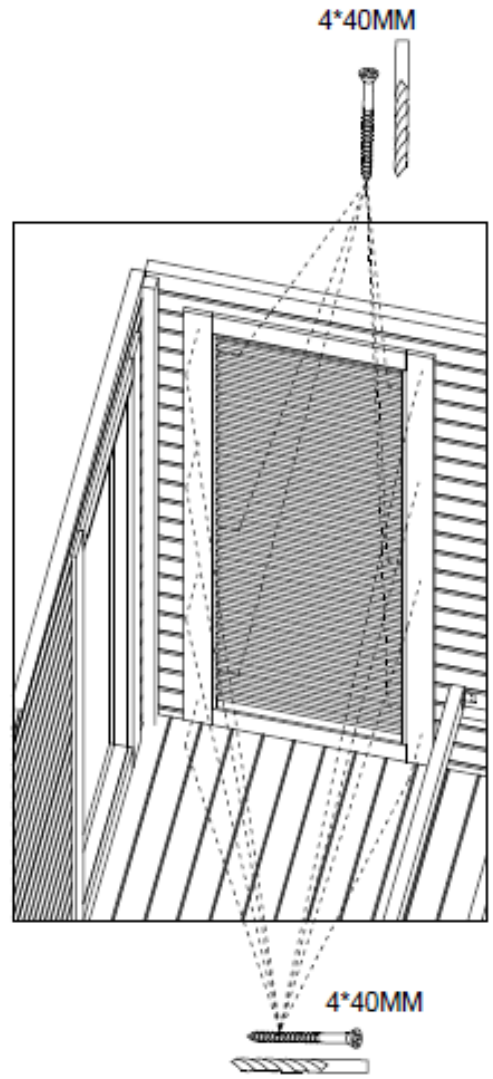
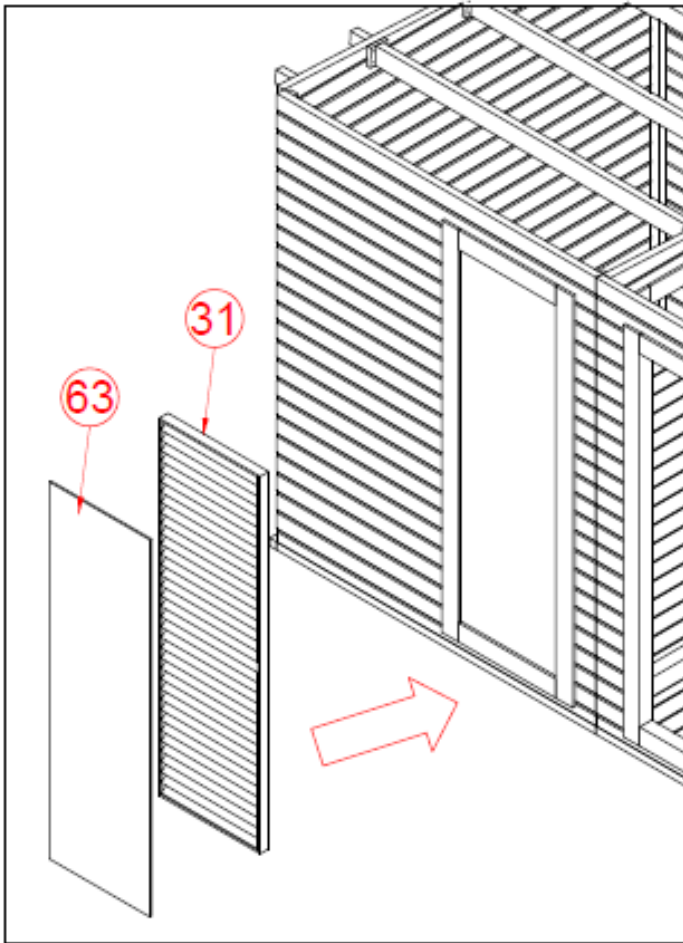

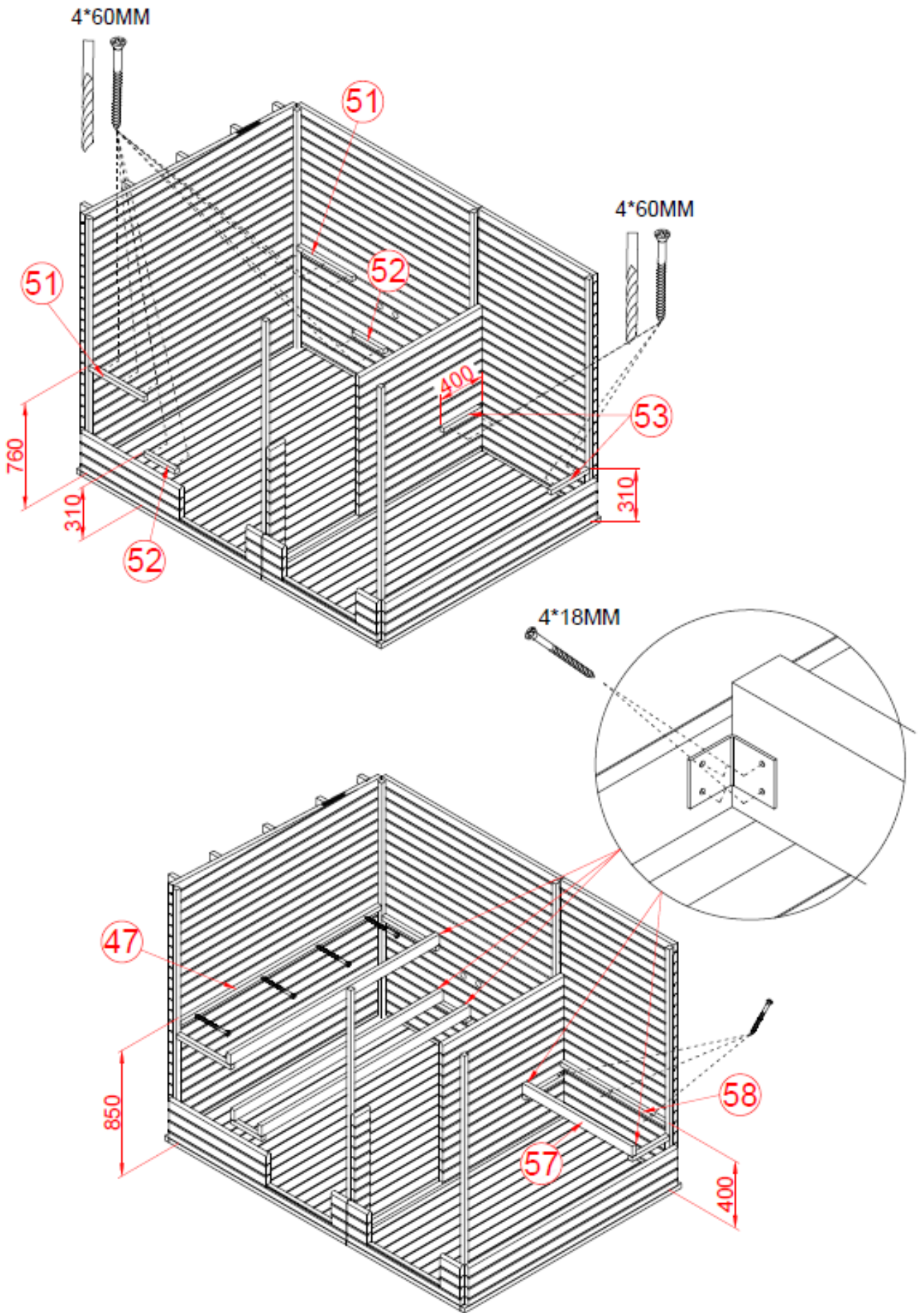

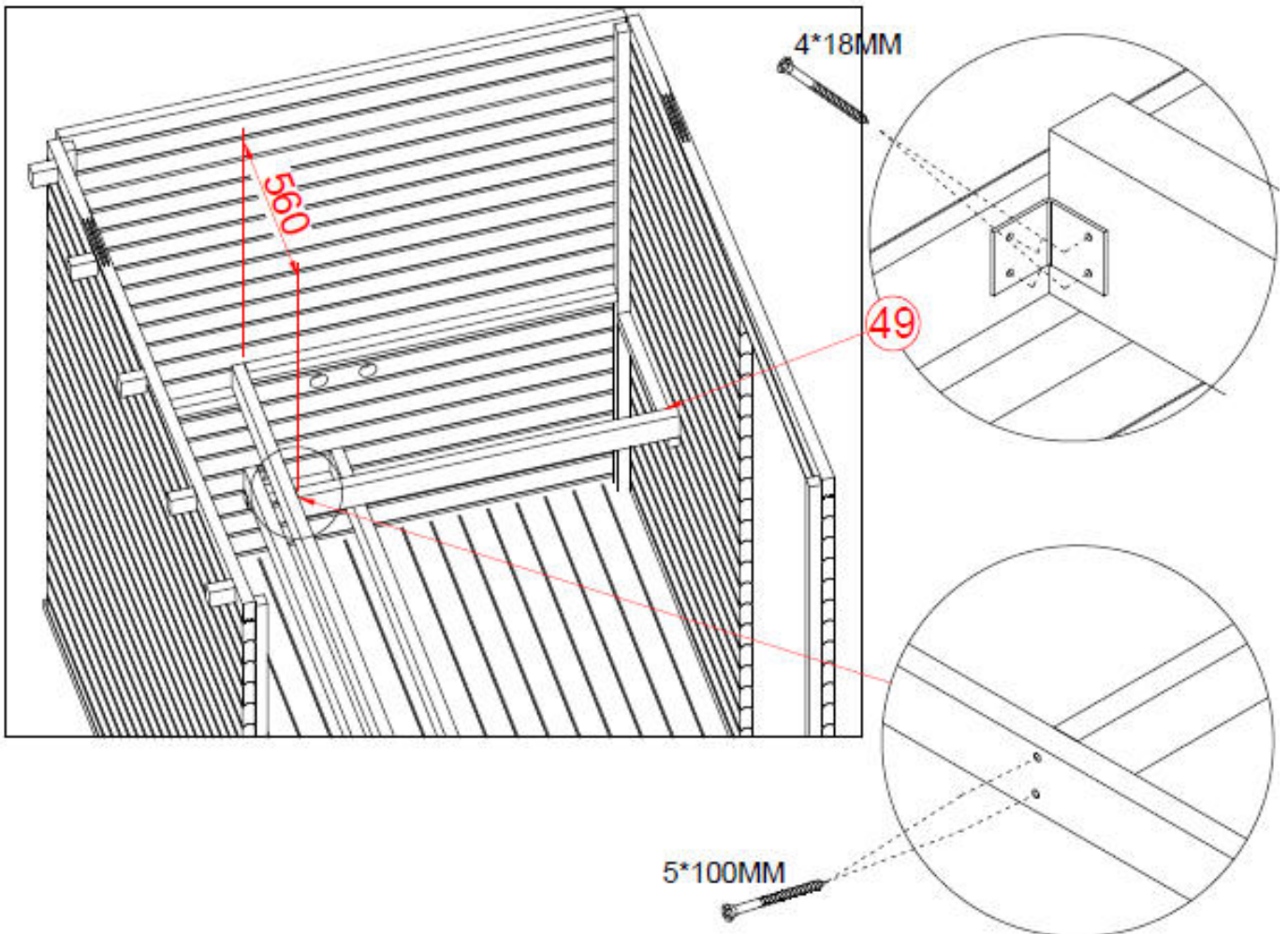
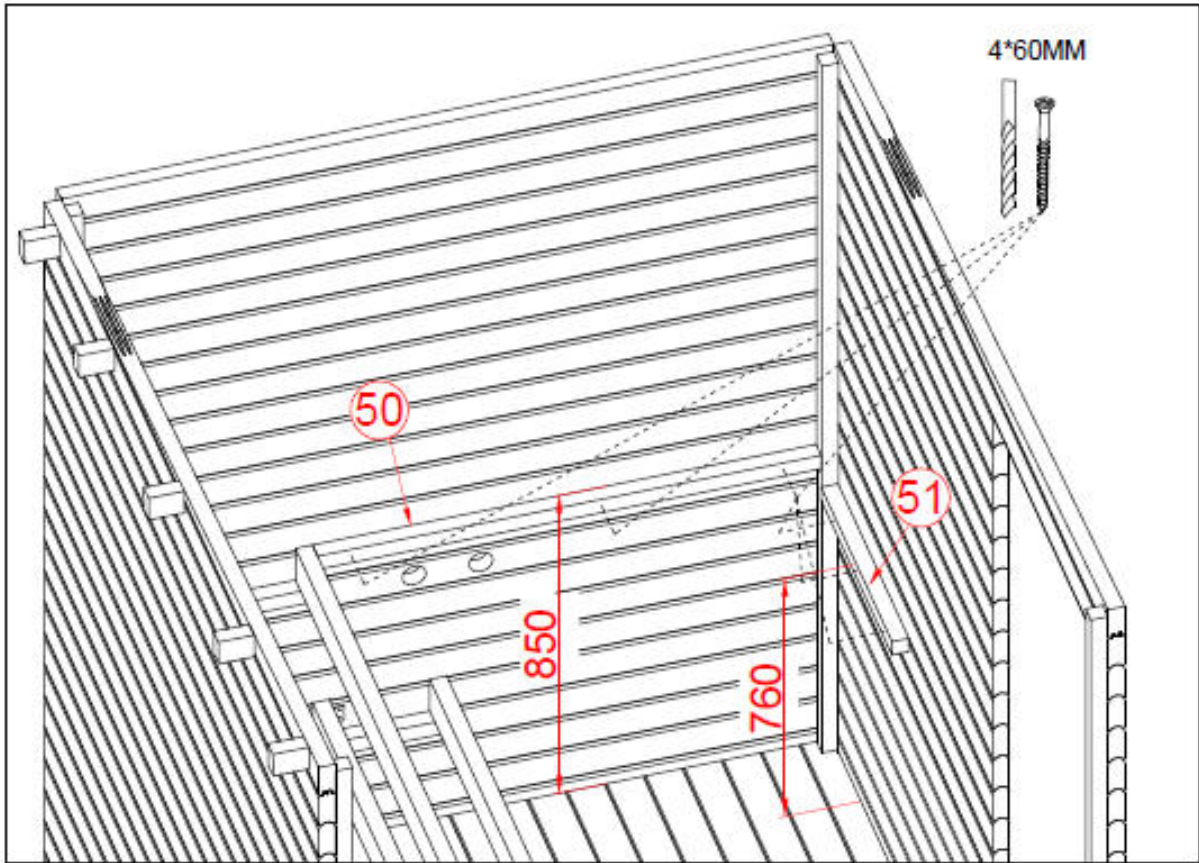

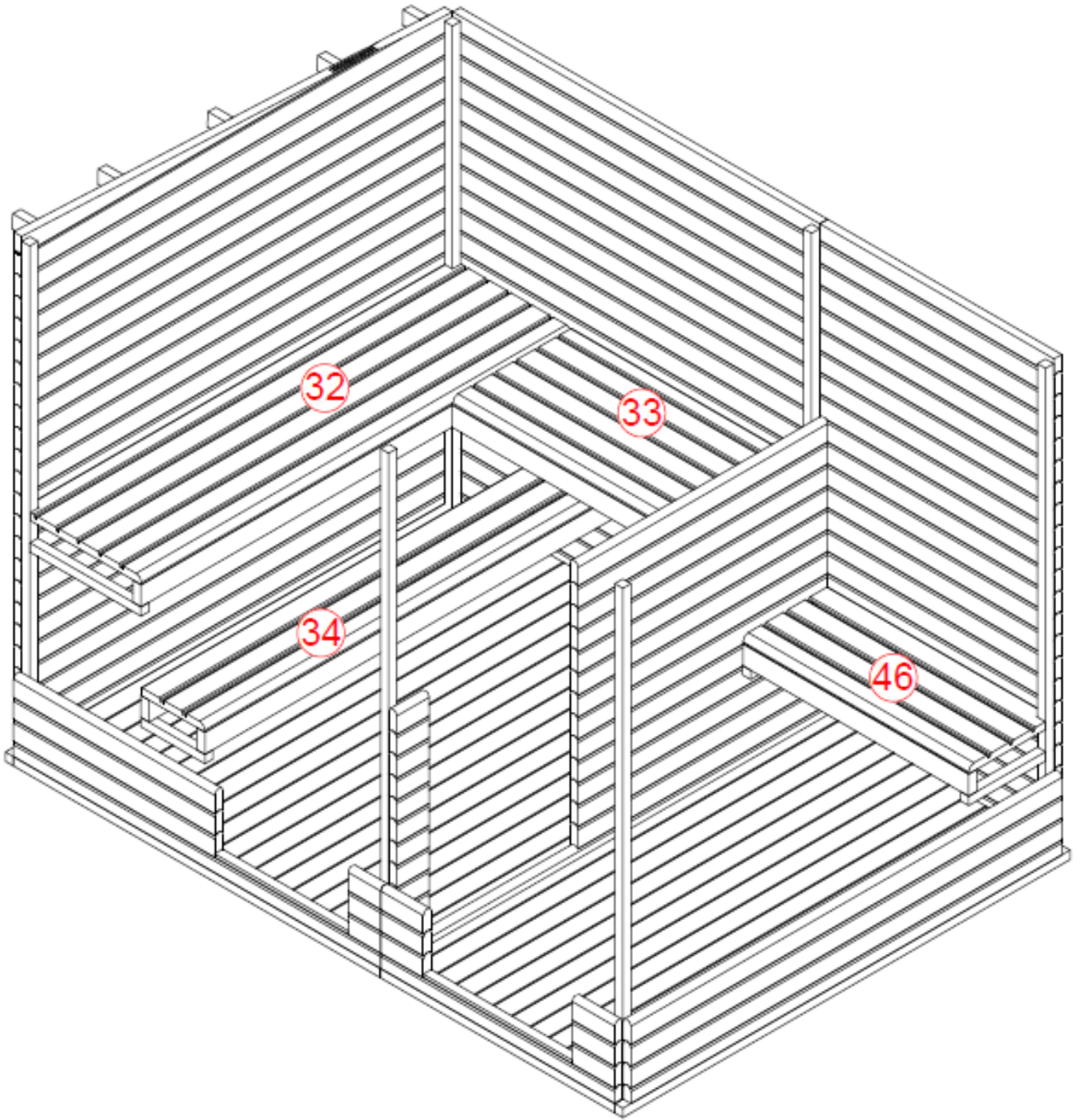

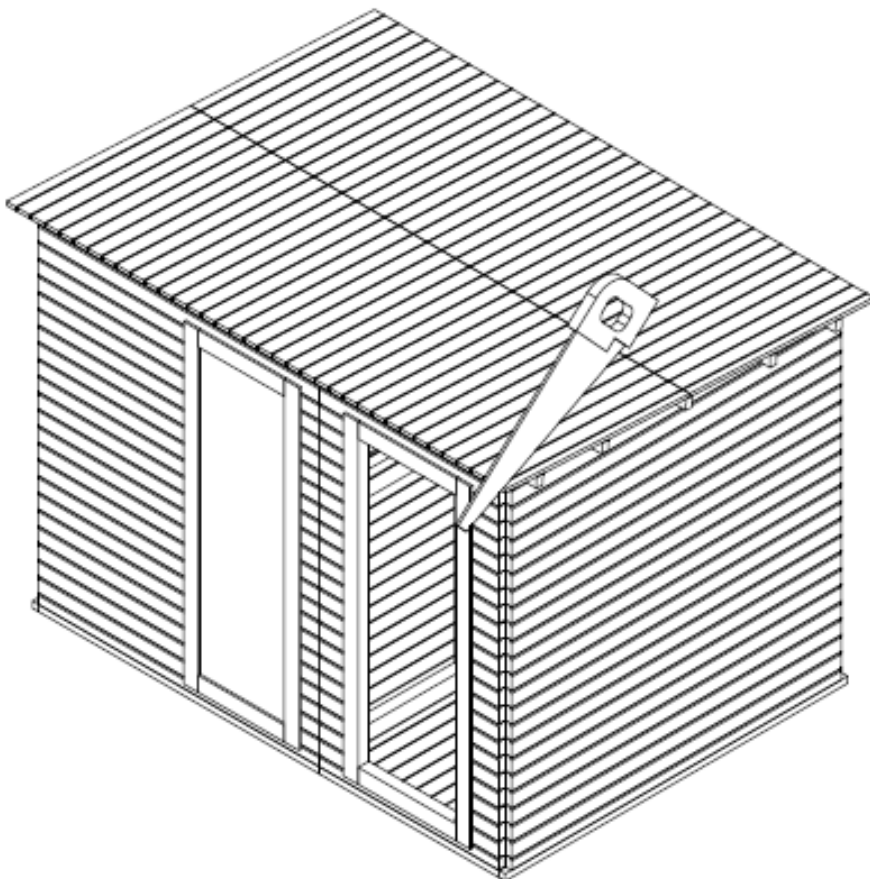
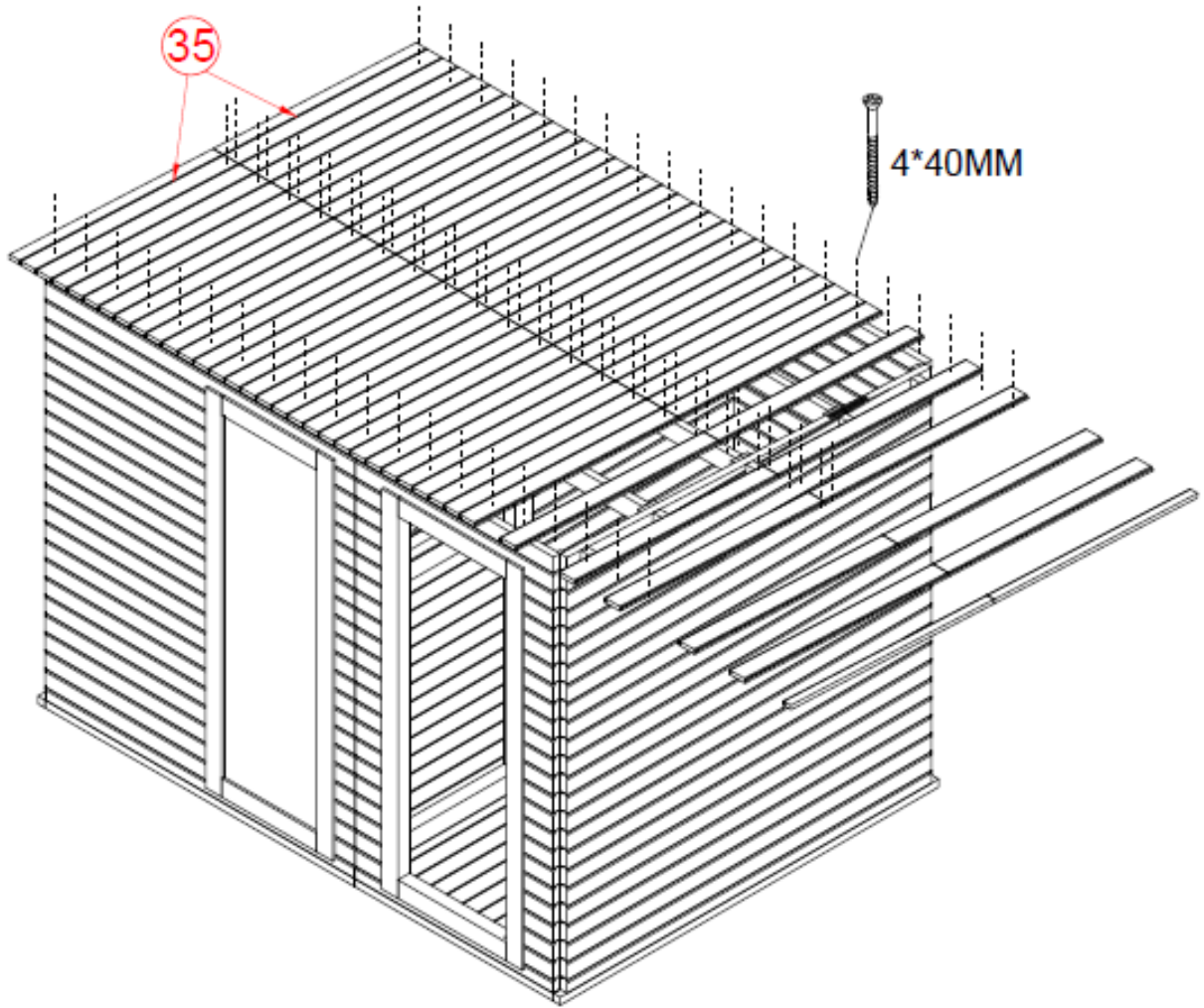

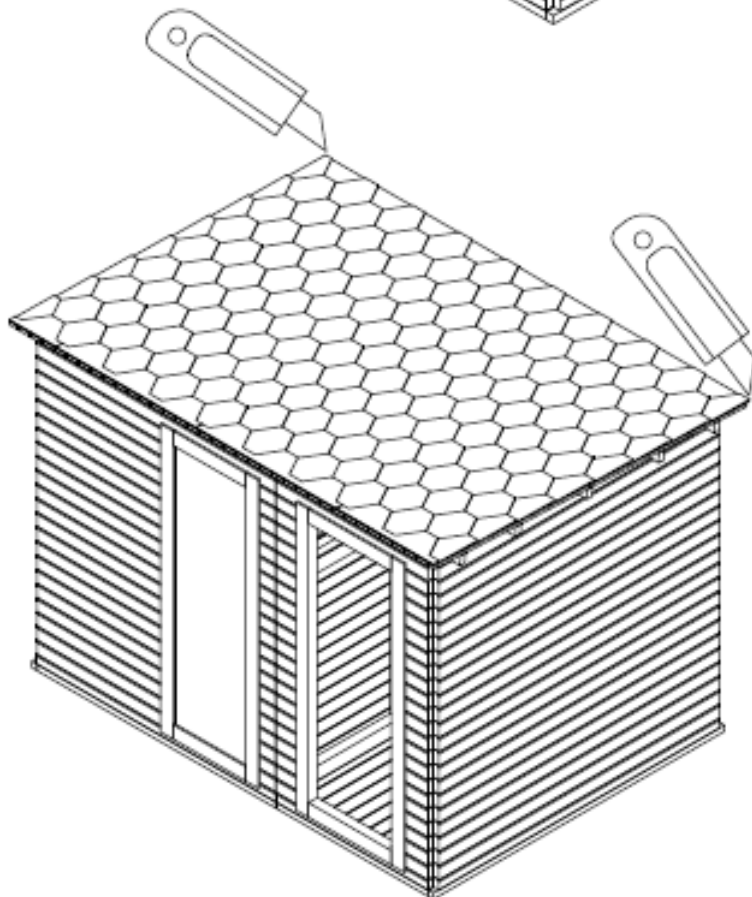
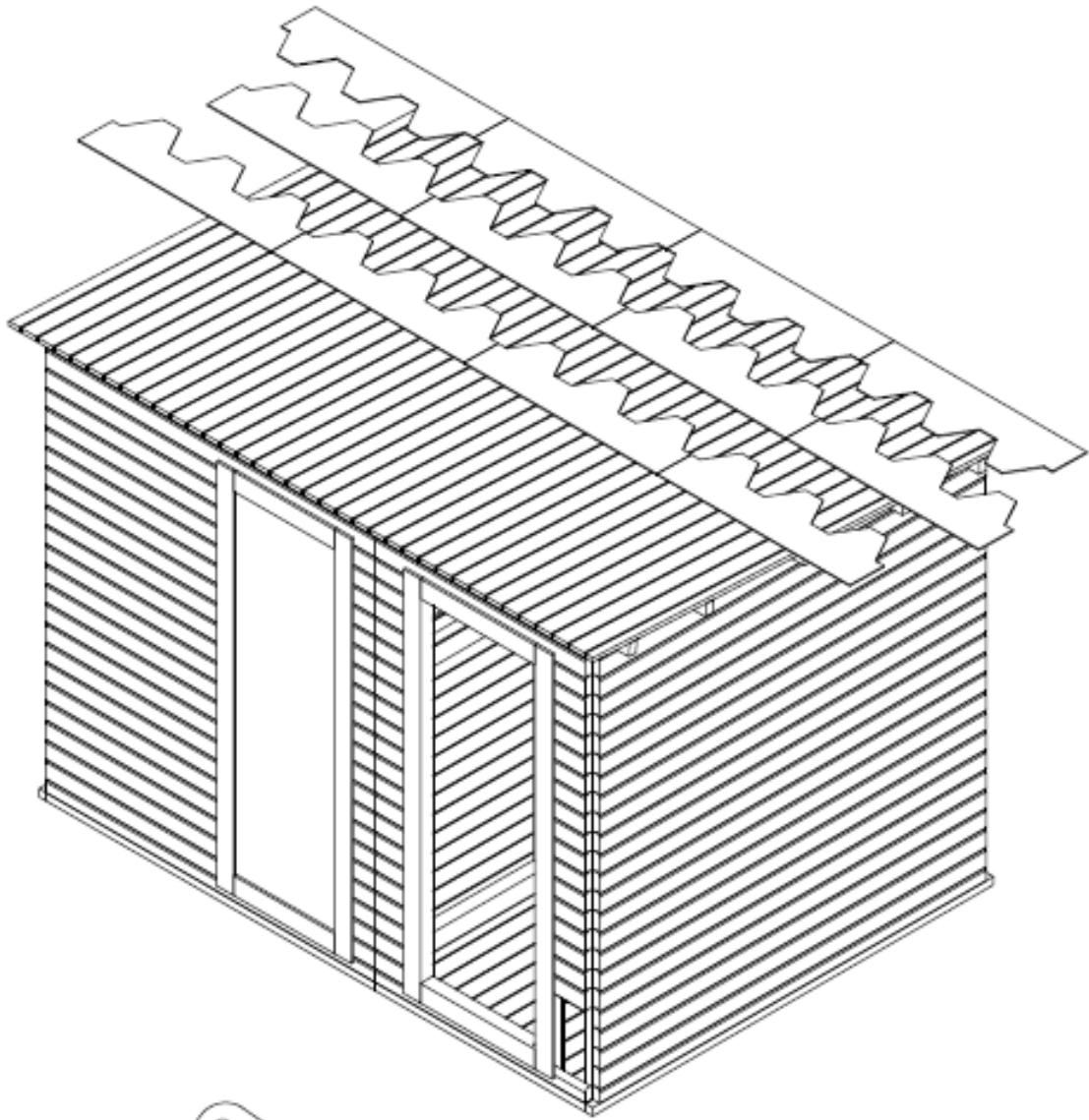

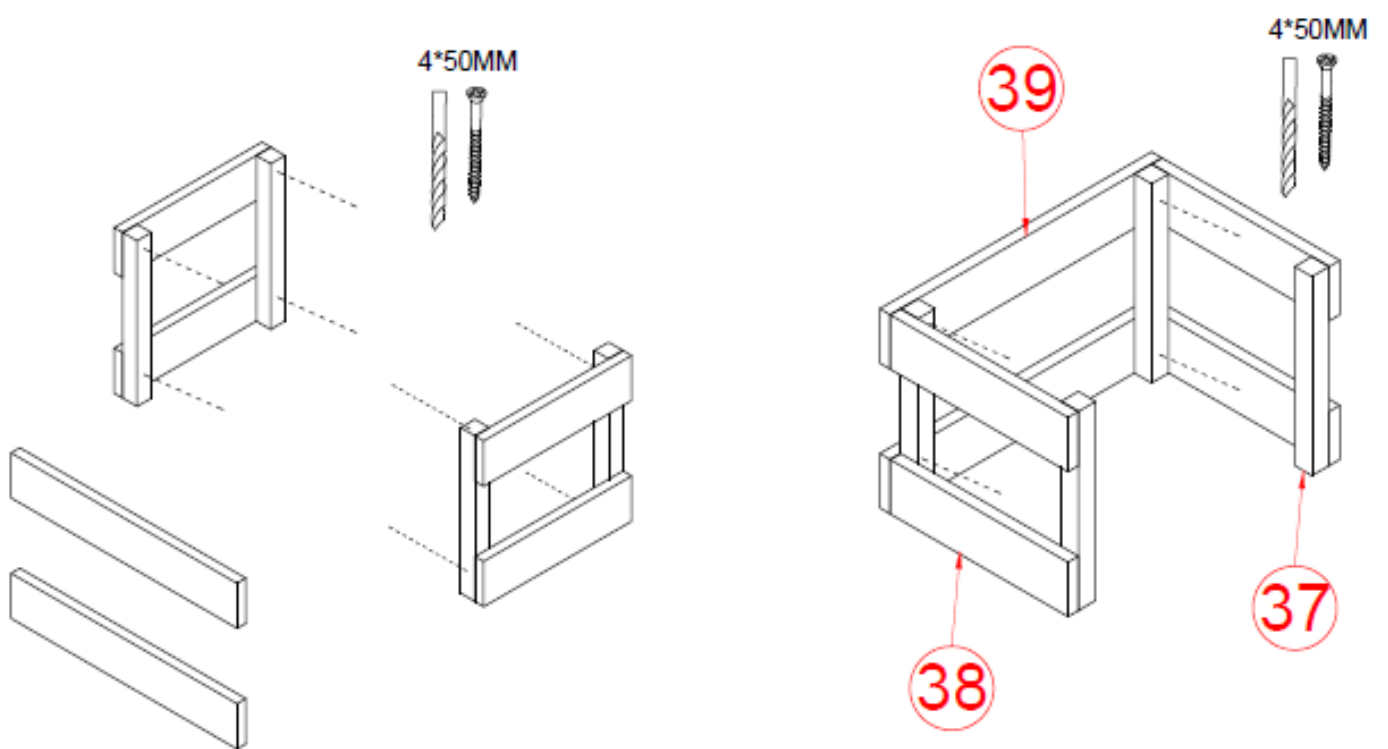
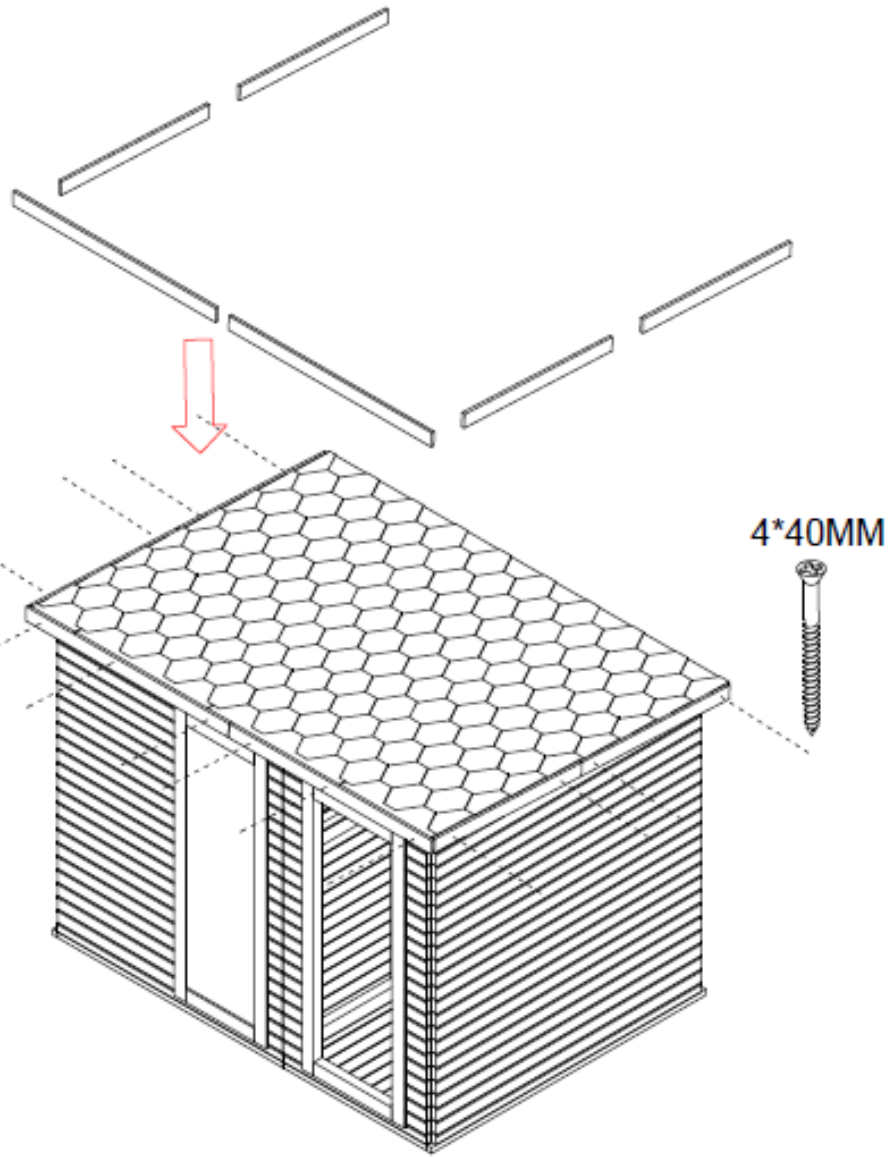

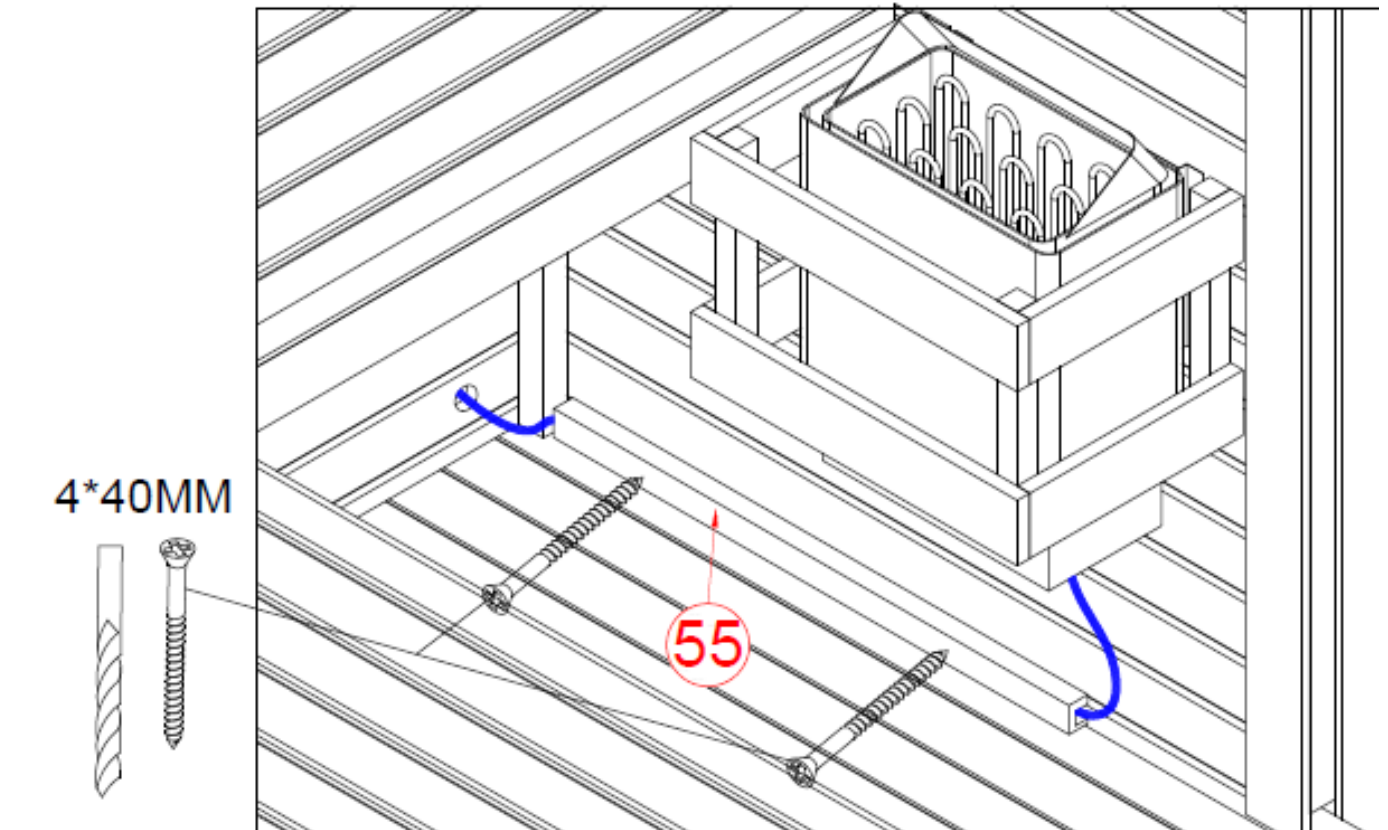
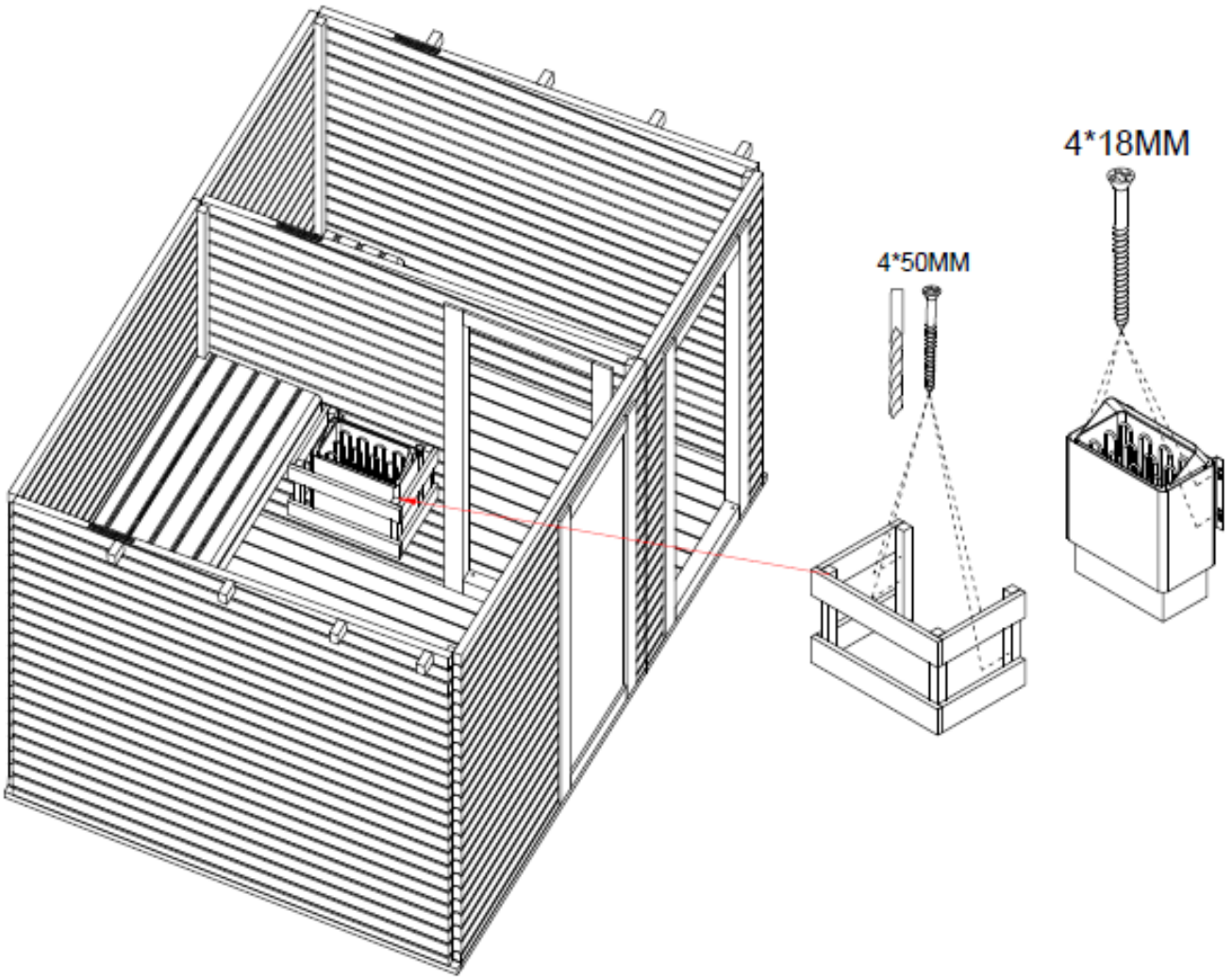

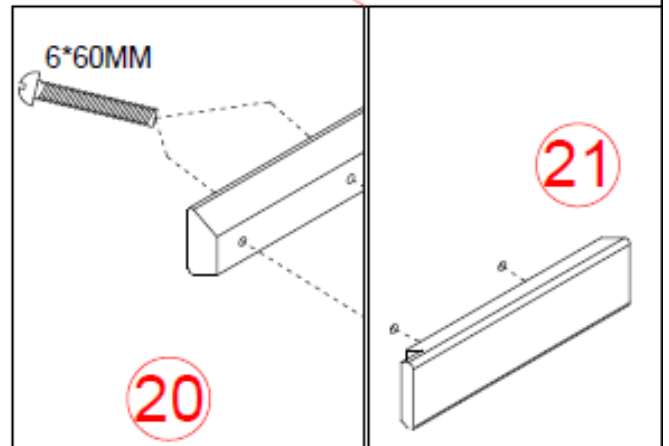
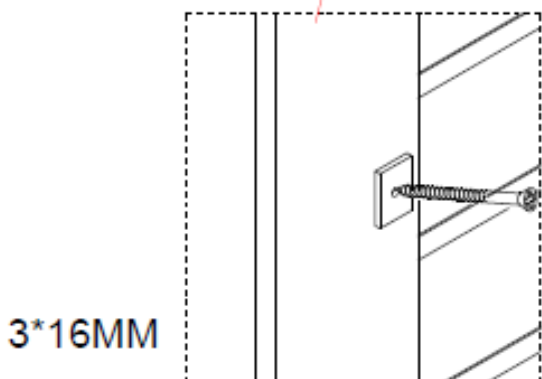
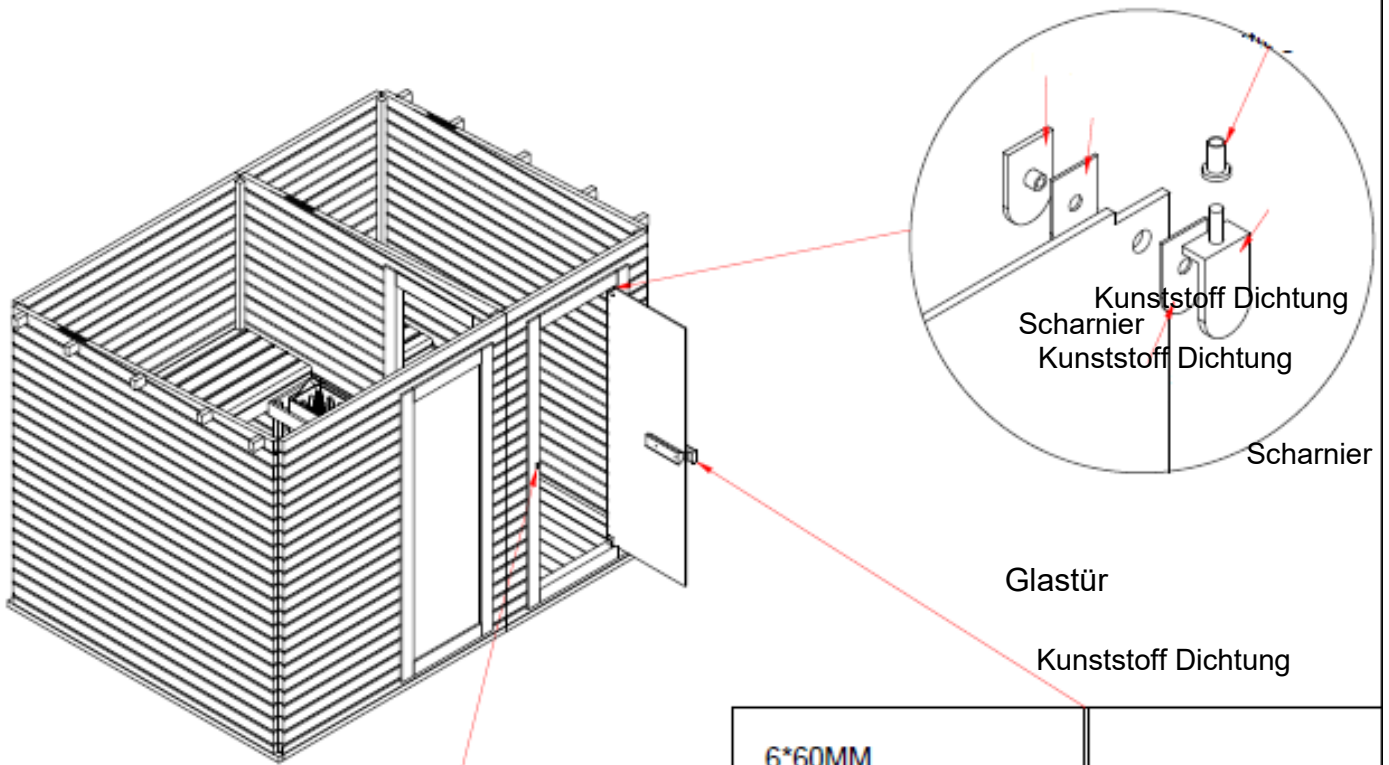
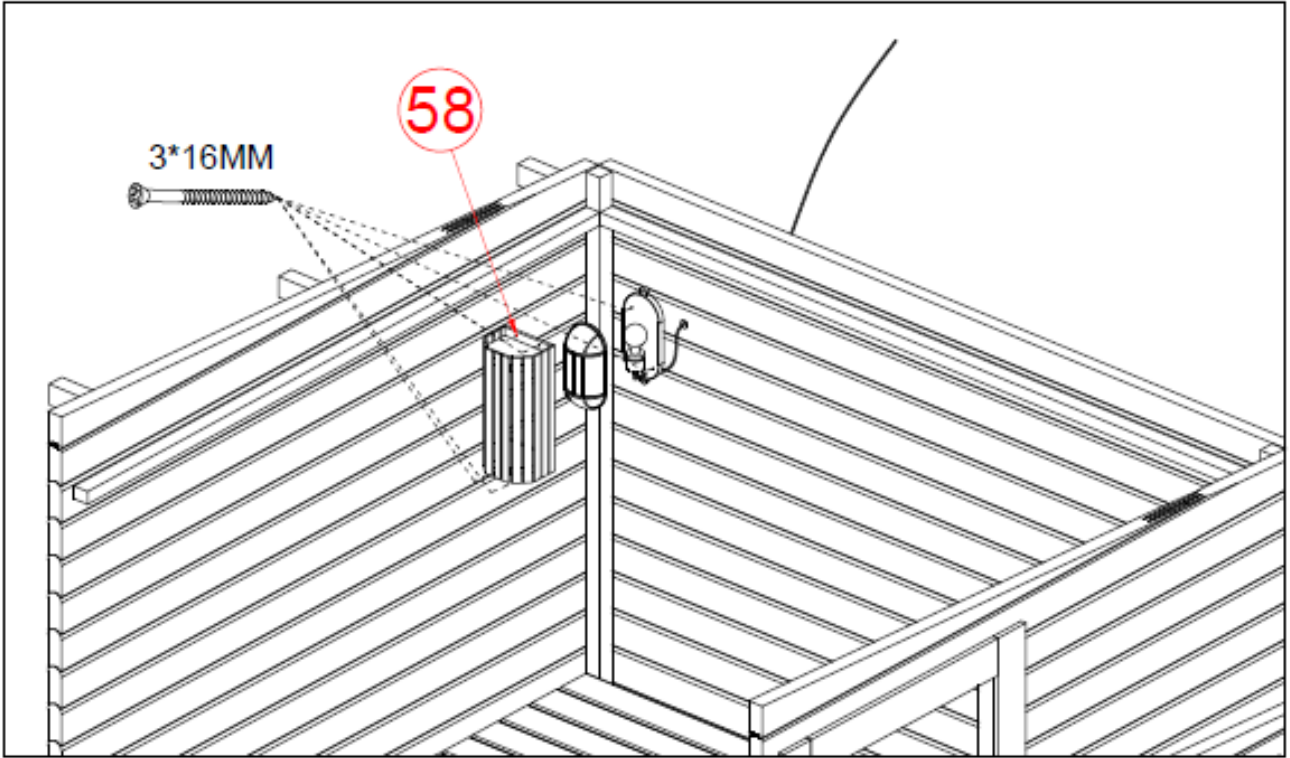

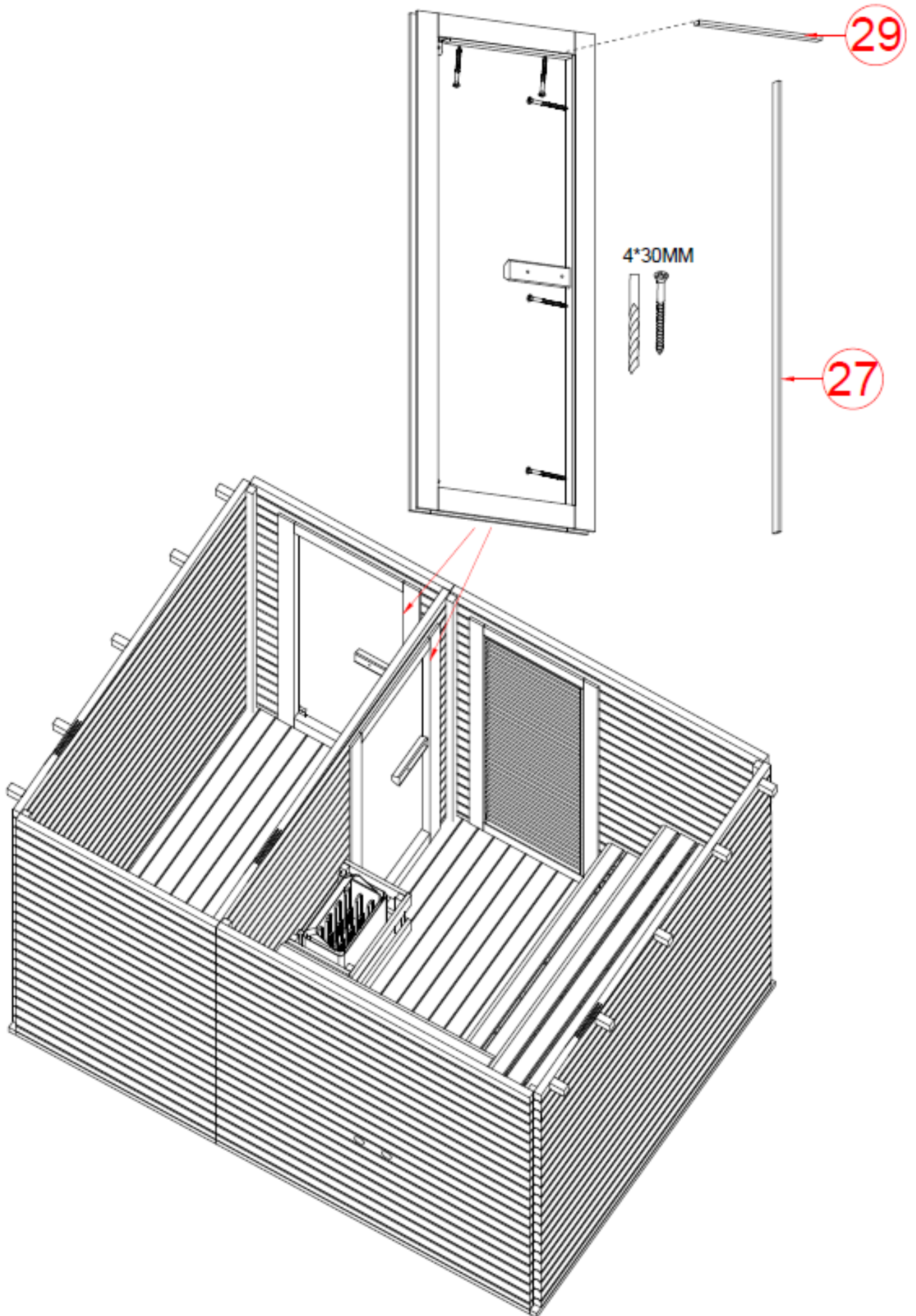

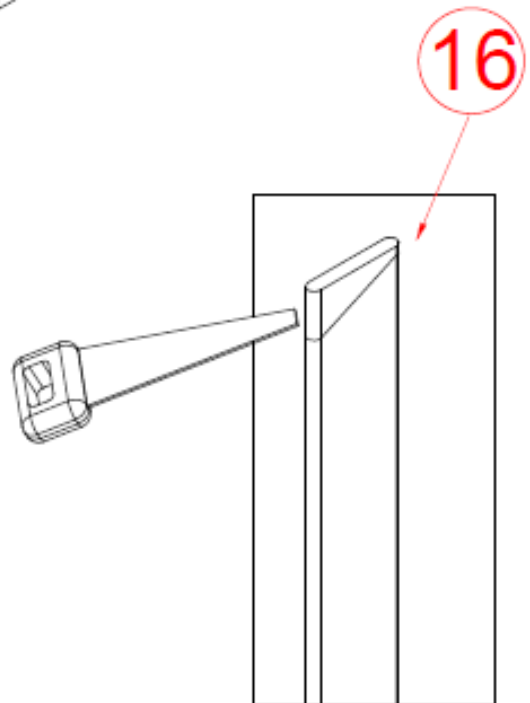
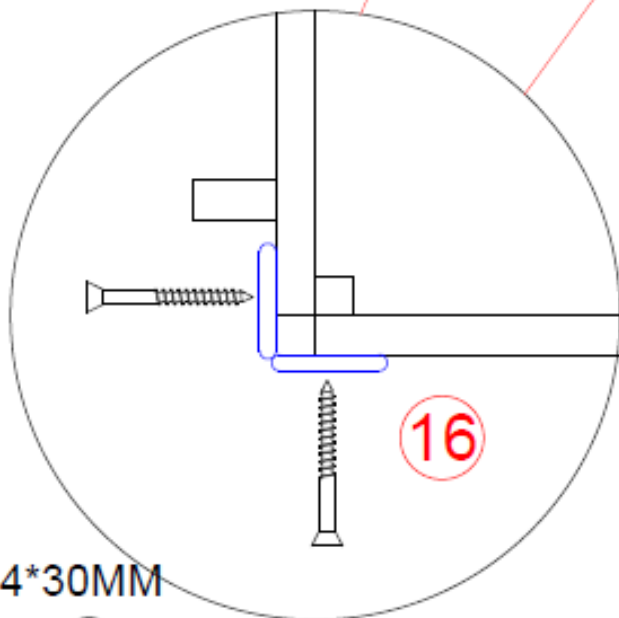
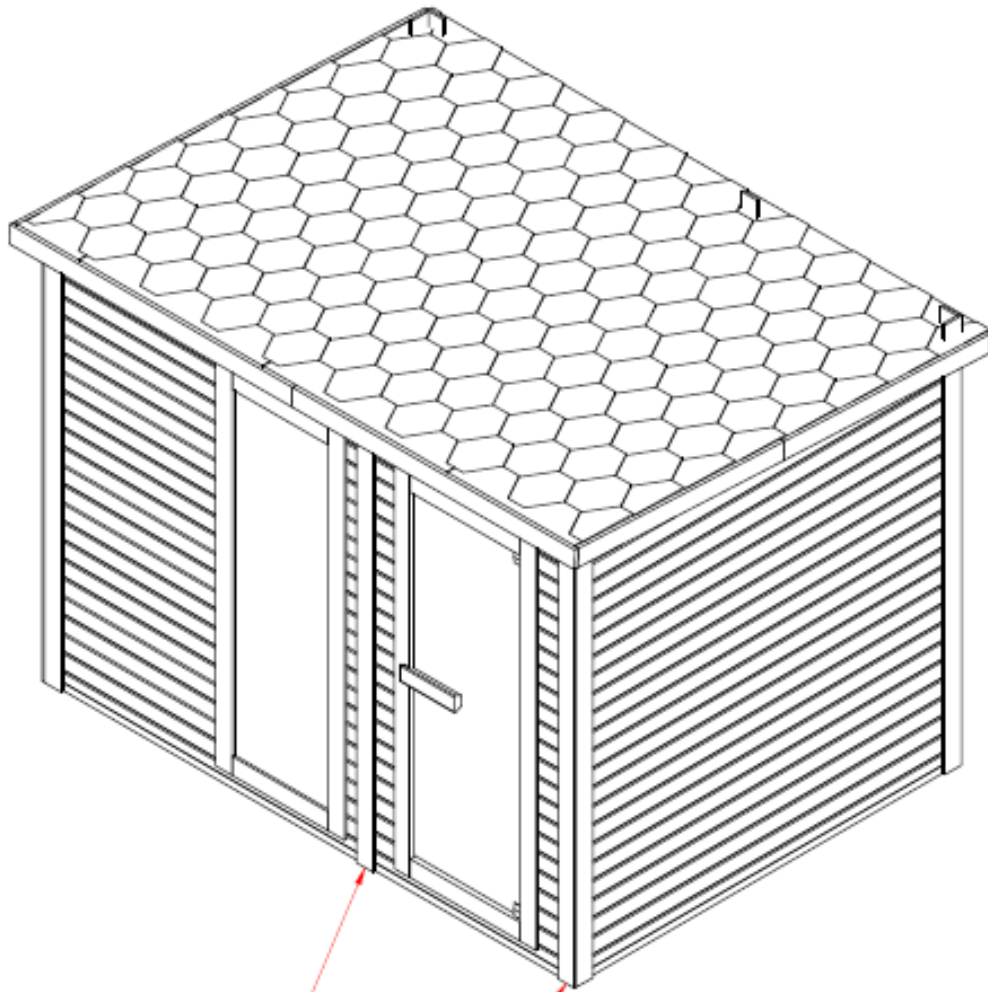

4*30MM

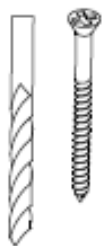

F30310

Instruction Manual

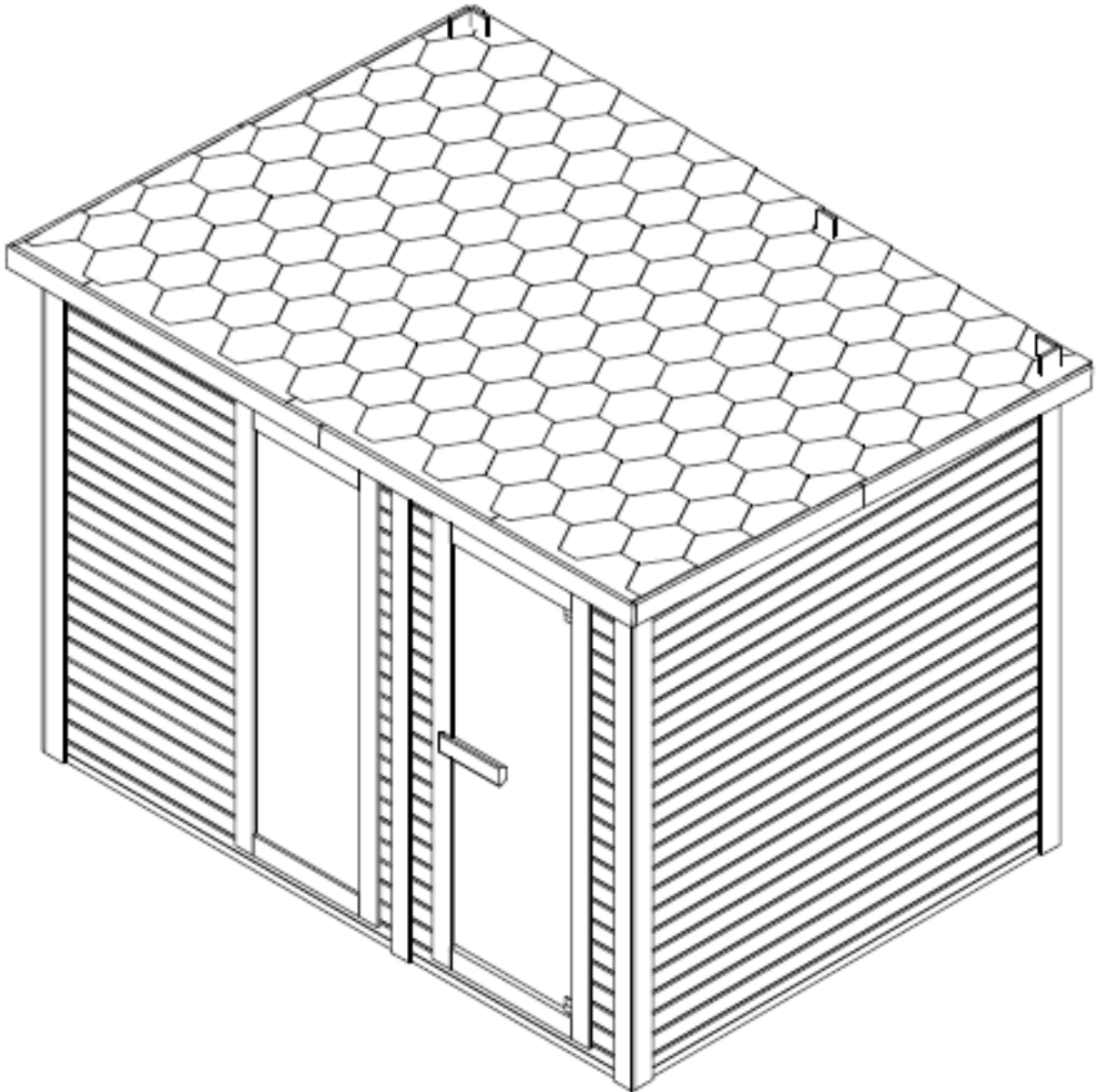

Attention

Read these instructions carefully before using your sauna for the first time.

We recommend that you store it in a safe place so that you can use it again in the future.

Please make a note of the serial number of the cabin control box, as this number will be required in the event of a repair or spare parts order.

- Wood is a living element. To maintain its original appearance, it is important to treat the outside of the wood against moisture.
- Place the sauna on a perfectly flat and hard surface.
- Do not use liquid cleaning agents. Switch off the sauna before cleaning and use a damp cloth.
- Protect the sauna's power cable so that it is not crushed or pinched.
- Before replacing certain components, make sure that they are prescribed by the manufacturer or have the same properties as the original parts. Incorrect replacement can cause a fire, short circuit or damage to the sauna. We strongly recommend that you consult a qualified technician.
- To avoid the risk of burns or electric shocks, do not use metal tools.
- Animals must not be brought into the sauna.
- Do not leave the sauna switched on unattended.
- Do not leave the sauna switched on for more than 1 hour at a time to avoid premature damage to the appliance. Switch the sauna off for at least 30 minutes after 1 hour of continuous operation.
- It is recommended not to install a locking system on the sauna door.
- Before connecting the sauna to the power supply, check that your electrical installation meets the requirements.
- Installation and repairs may only be carried out by a qualified electrician!
- Only use original parts.
- Switch off the sauna when not in use.

DANGER

- Covering the ovens leads to a fire hazard due to overheating. Do not cover the heating elements!
- Always keep flammable or highly flammable materials/objects (e.g. towels) away from the heater.
- Do not touch the heater during and shortly after use, as there is a risk of burns from the hot parts.
- The light bulb heats up during operation. If the light bulb needs to be replaced, unplug the heater from the cabin and allow the light bulb to cool down
- cool down before replacing it.

Safety

IMPORTANT!

Please read the safety instructions carefully before setting up and using your sauna cabin.
The instructions are important for your safety, so please adhere strictly to them.

Achten Sie auf Hyperthermie, Hitzschlag oder Hitzeerschöpfung, die durch Nichtbeachtung der Sicherheitshinweise verursacht oder verschlimmert werden können. Die Symptome sind Fieber, schneller Puls, Schwindel, Ohnmacht, Lethargie und Taubheitsgefühl im ganzen Körper oder in Teilen des Körpers. Die Auswirkungen sind: verminderte Wahrnehmung der Hitze, Unkenntnis der drohenden Gefahren, Bewusstlosigkeit.

Watch out for hyperthermia, heat stroke or heat exhaustion, which can be caused or worsened by not following the safety instructions. Symptoms include fever, rapid pulse, dizziness, fainting, lethargy and numbness throughout the body or in parts of the body. The effects are: reduced perception of heat, lack of awareness of impending danger, unconsciousness.

The sauna may not be used by:

- Children under 6 years of age.
- People with strong reactions to sunlight.
- People with pre-existing conditions such as heart disease, high or low blood pressure, circulatory disorders or diabetes without prior medical advice.
- Pregnant women. Excessive temperature can endanger the fetus.
- People suffering from dehydration, open wounds, eye diseases, burns or sunstroke.

Children between the ages of 6 and 16 may use the sauna provided they are constantly supervised by a responsible adult and the temperature does not exceed 60°C.

If you have health problems, are taking medication or have injured muscles or ligaments, you may only use the sauna after prior consultation with and approval from a doctor.

If you have surgical implants, you may not use the sauna without first consulting a doctor and obtaining their approval.

Do not use the sauna after strenuous activity. Wait 30 minutes until your body has cooled down.

Do not spend more than 40 minutes at a time in the sauna.

Do not consume alcohol or drugs before or during the session.

Do not sleep in the sauna when it is in operation.

To avoid the risk of overheating, connect your sauna to a sufficiently powerful socket and do not connect any other electrical appliances to the same socket.

To avoid the risk of electric shock or damage to the sauna, it must not be used:

- During a thunderstorm.
- If the electrical cable is damaged, it must be replaced by a qualified person.
- If the power cable overheats, it must be checked by a qualified person.
- If you need to change a light bulb, wait until the sauna is switched off and has cooled down.
- Dry your hands before connecting or disconnecting the power.

Never work with wet hands or feet.

Do not switch the power or heating on or off quickly, as this could damage the electrical system.

Do not attempt to repair the sauna yourself without the consent of the sauna dealer or the manufacturer.

Unauthorized repair attempts will void the manufacturer's warranty.

Do not use cleaning agents in the sauna.

Do not stack or store any objects in or on the sauna.

Do not place any flammable materials or chemical substances near the sauna.

Do not cover the heating elements!





Do not touch the heater during and shortly after use, as there is a risk of burns due to the hot parts.



Switch off the cabin when not in use.

Technical data:

Modell	F30310
Material der Kabine	Spruce wood
Tiefe	2300mm
Breite	3100mm
Höhe	2200mm
Spannung	AC380V
Saunaofen	8KW

Assembly material (deviations possible)

											
Ø3x16	Ø4x70	Ø4x60	Ø4x50	Ø4*40	Ø4*30	Ø4*18	Ø5*100	Ø6x60	Wood pad		
6x	103x	300x	76x	240x	62x	40x	2x	4x	2x	2x	4x

		
2x	10x	2x

Please remove the transport packaging and check that your infrared cabin has been delivered complete and undamaged before you start assembling it.

Read the assembly instructions carefully before you have found a suitable place for your sauna.
The sauna is designed for outdoor installation only.

Select an area:

- In a dry place on a flat, stable surface that can support the weight of your sauna.
- The height must be sufficient to allow you to reach the ceiling and carry out electrical connections and maintenance work.
- Keep away from water sources, flames or flammable materials.

Practical advice

- Please note that at least 2 adults are required to set up the sauna.
- Identify each panel clearly before you start
- When installing, lay the power cable of your sauna so that it is easily accessible.
- Please note that there are differences between the models.

IMPORTANT :





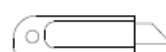
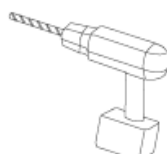
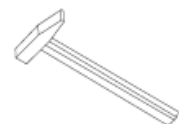
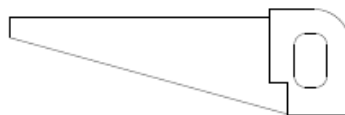
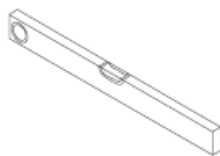



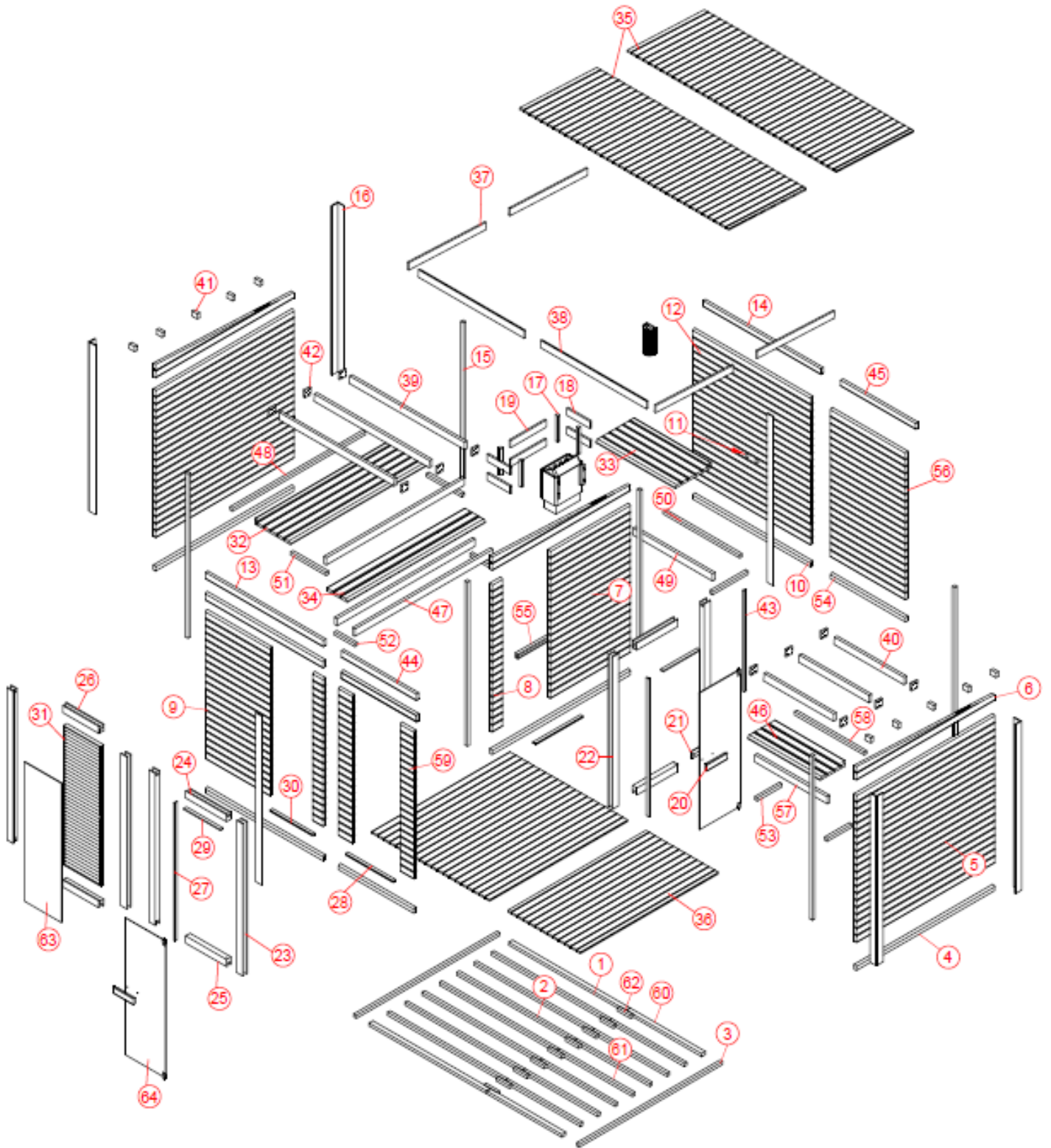

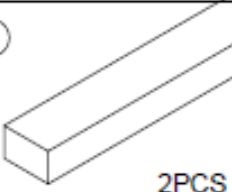
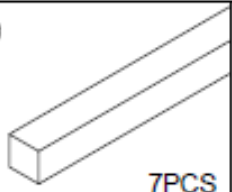
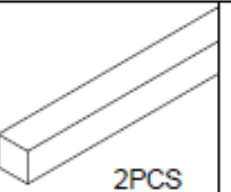
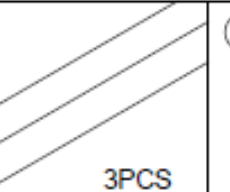
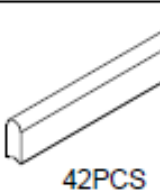

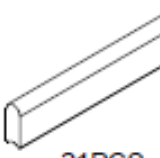

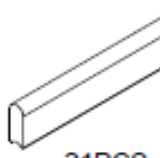

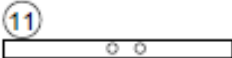
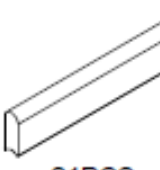
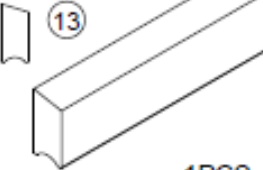

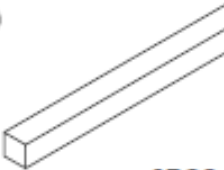
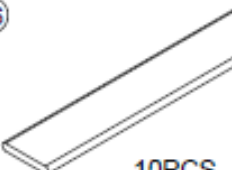
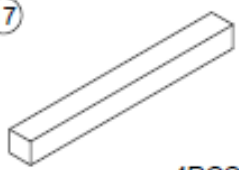

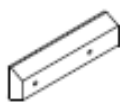
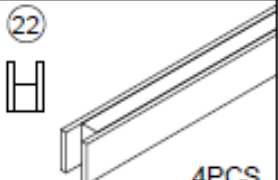
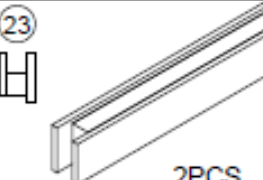

Please check the countersink and hole diameter of the drill holes to avoid damaging the wood.

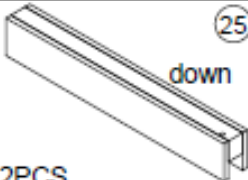
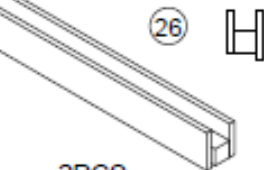



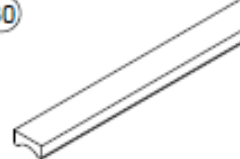

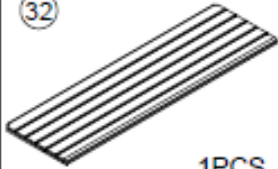
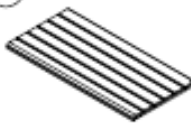

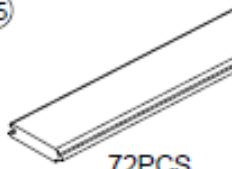
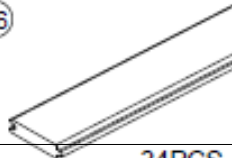
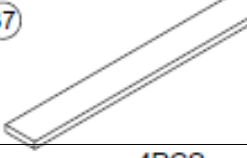
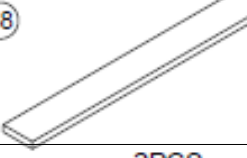
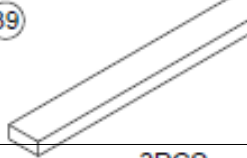
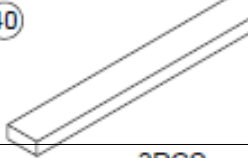





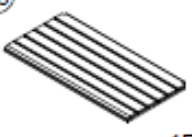





Tools:

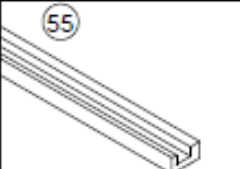
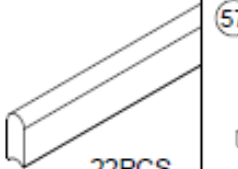
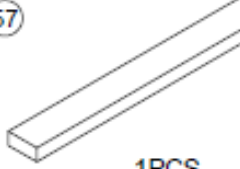

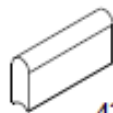
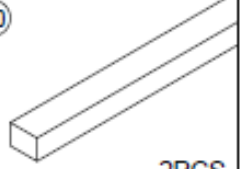
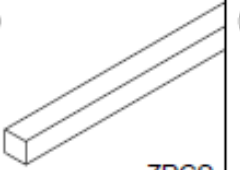
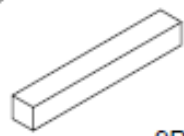
Parts list:

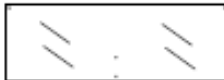

 ① 2PCS	 ② 7PCS	 ③ 2PCS	 ④ 3PCS	 ⑤ 42PCS
1724*55*38mm	1724*38*38mm	2100*38*38mm	2024*67*38mm	2024*97*38mm
 ⑥ 3PCS	 ⑦ 21PCS	 ⑧ 42PCS	 ⑨ 21PCS	 ⑩ 2PCS
2024*168*38mm	1172*97*38mm	150*97*38mm	945*97*38mm	1724*67*38mm
 ⑪ 1PCS	 ⑫ 21PCS	 ⑬ 1PCS	 ⑭ 1PCS	 ⑮ 6PCS
1724*97*38mm	1724*97*38mm	1724*81*38mm	1724*70*38mm	2188*38*38mm
 ⑯ 10PCS	 ⑰ 4PCS	 ⑱ 2PCS	 ⑲ 4PCS	 ⑳ 1PCS
2140*90*13mm	330*33*33mm	520*90*20mm	340*90*20mm	300*90*40mm
 ⑳ 1PCS	 ㉒ 4PCS	 ㉓ 2PCS	 ㉔ 2PCS	 ㉕ 2PCS
252*90*40mm	1927*90*66mm	1927*90*66mm	600*90*66mm	600*90*66mm
 ㉖ 2PCS	 ㉗ 2PCS	 ㉘ 2PCS	 ㉙ 2PCS	 ㉚ 1PCS
547*90*66mm	1747*40*13mm	700*38*17mm	537*40*13mm	627*38*17mm
 ㉛ 1PCS	 ㉜ 1PCS	 ㉝ 1PCS	 ㉞ 1PCS	 ㉟ 72PCS
1765*545*47mm	2022*560*33mm	1162*560*33mm	2022*300*33mm	1130*97*18mm
 ㉿ 34PCS	 ㊀ 4PCS	 ㊁ 2PCS	 ㊂ 3PCS	 ㊃ 3PCS

 10PCS 80*60*38mm	 12PCS 90*90*20mm	 1PCS 1550*33*13mm	 1PCS 1100*81*38mm	 1PCS 1100*70*38mm
 1PCS 1060*400*33mm	 3PCS 2022*90*38mm	 1PCS 1946*38*38mm	 1PCS 1162*90*38mm	 1PCS 1124*38*38mm
 3PCS 522*38*38mm	 2PCS 300*38*38mm	 2PCS 362*38*38mm	 2PCS 1100*67*38mm	 1PCS 820*40*20mm
 22PCS 1100*97*38mm	 1PCS 1060*90*38mm	 1PCS 1022*38*38mm	 42PCS 198*97*38mm	 2PCS 1100*55*38mm
 7PCS 1100*38*38mm	 9PCS 200*38*38mm	 1PCS 1764*544*6mm	 1PCS 1733*594*6mm	 1PCS 300*142*105MM
 Sauna light	 Sauna stove	 69PCS 1000*320*5mm		

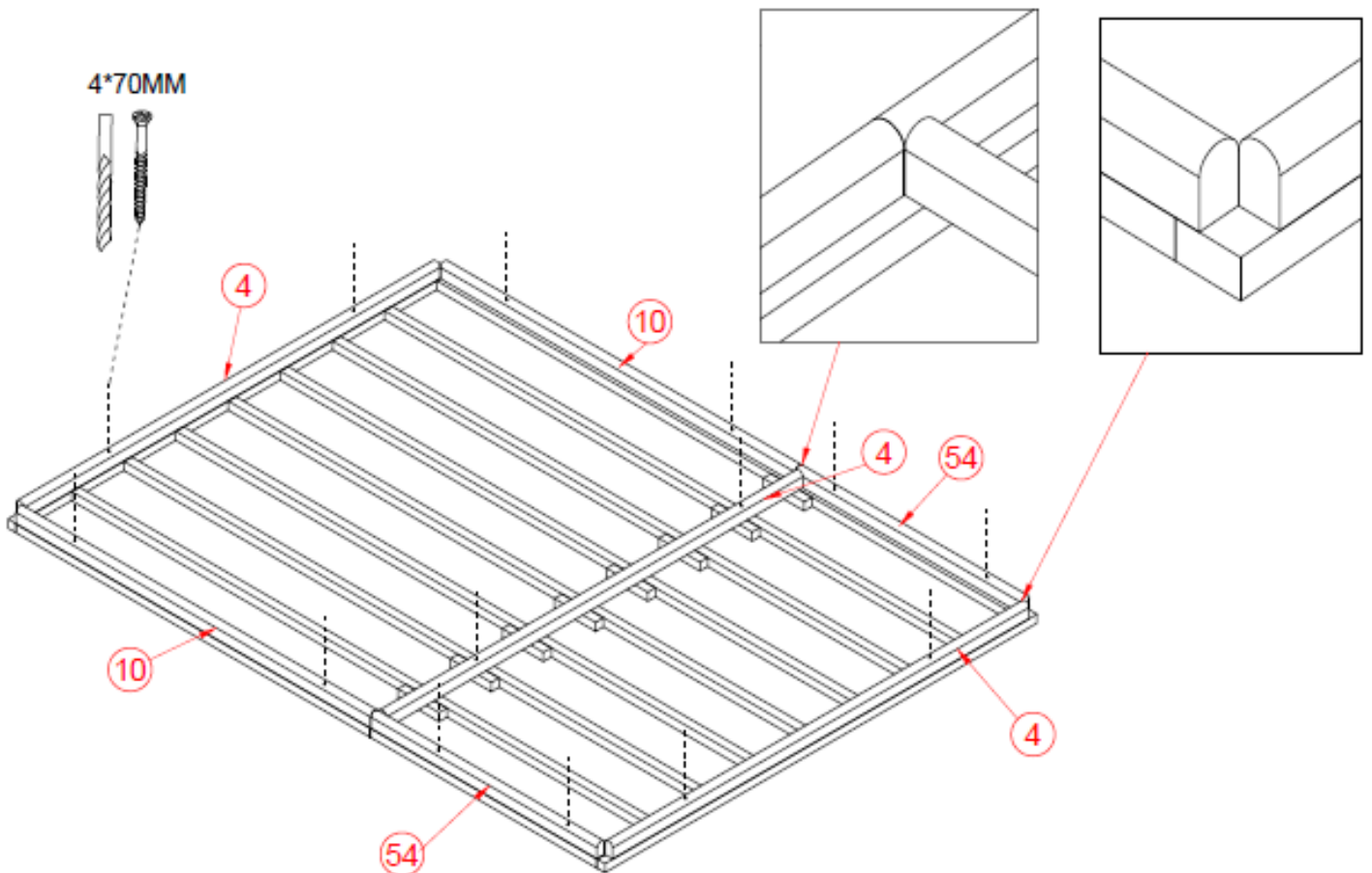
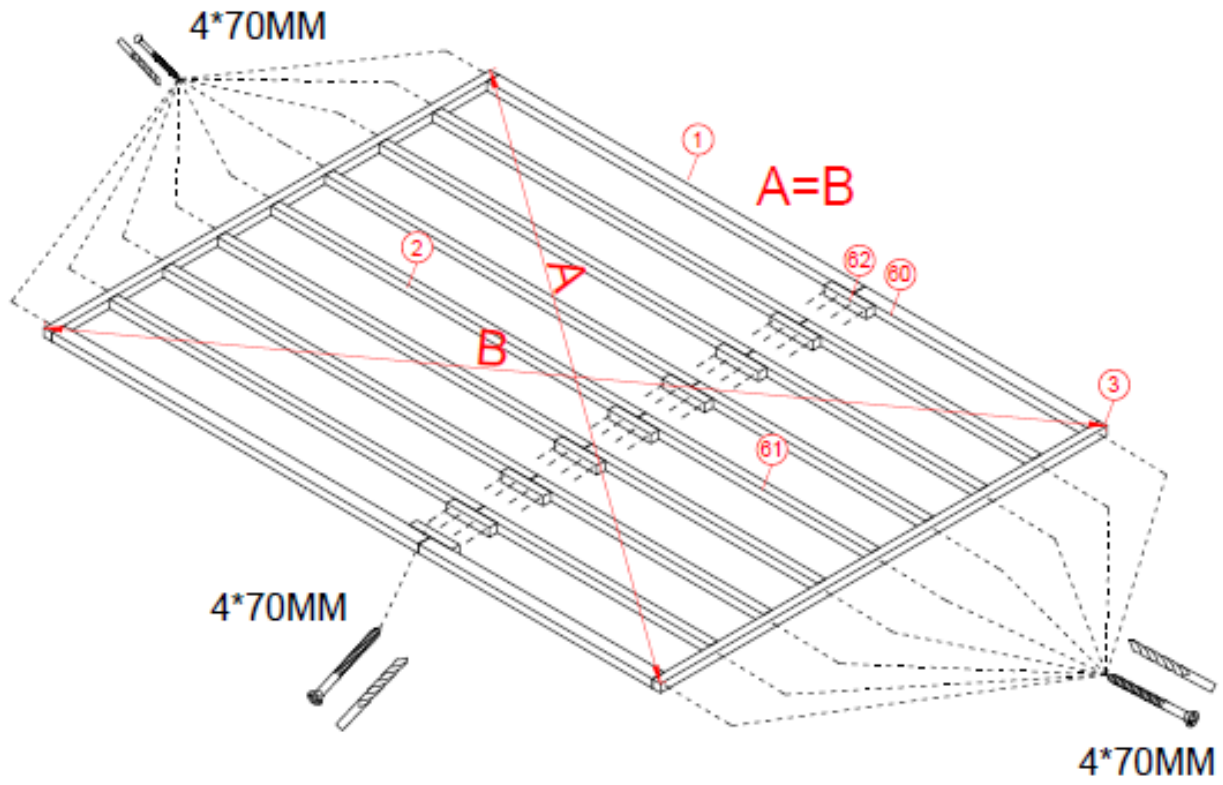

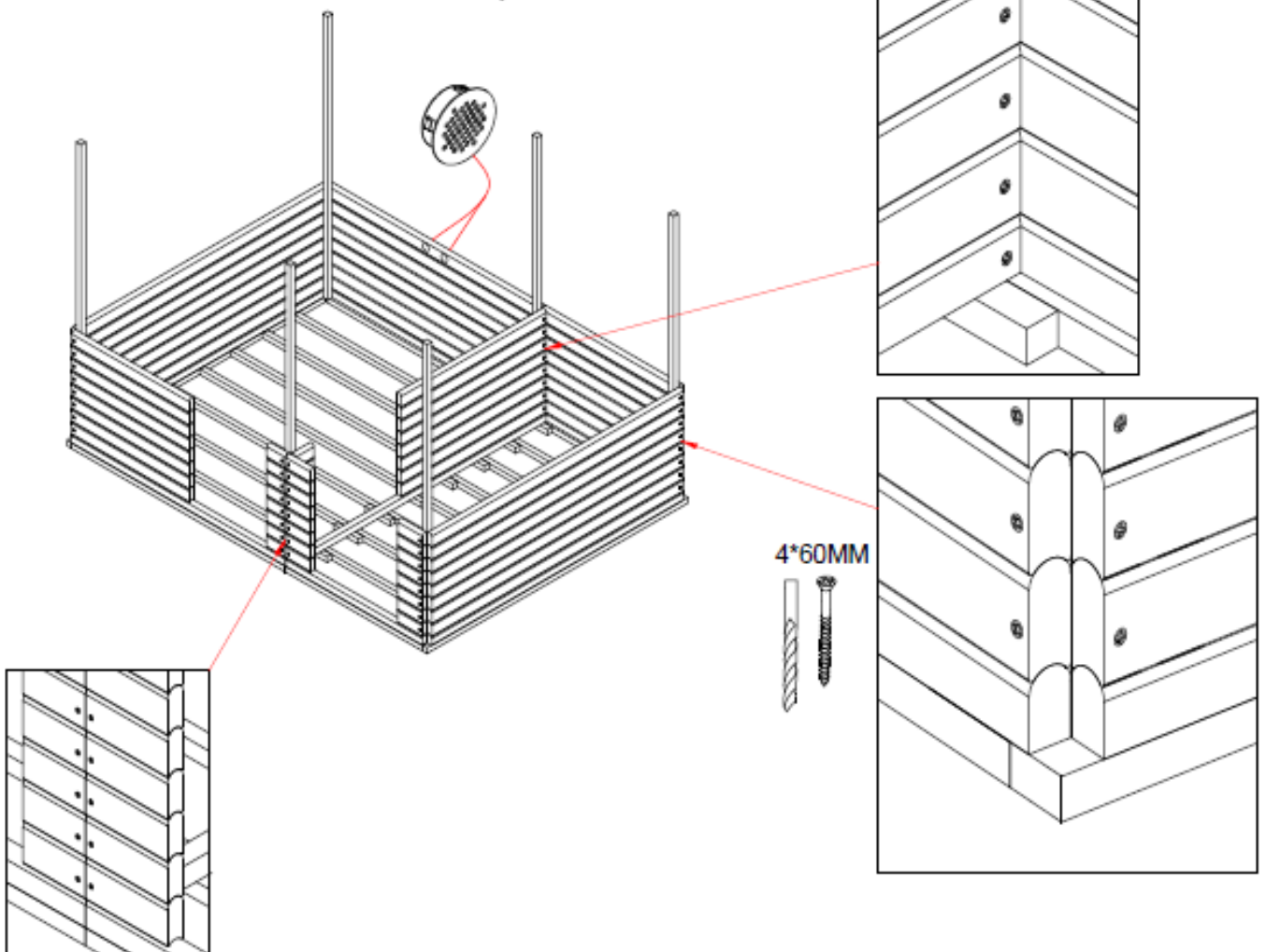
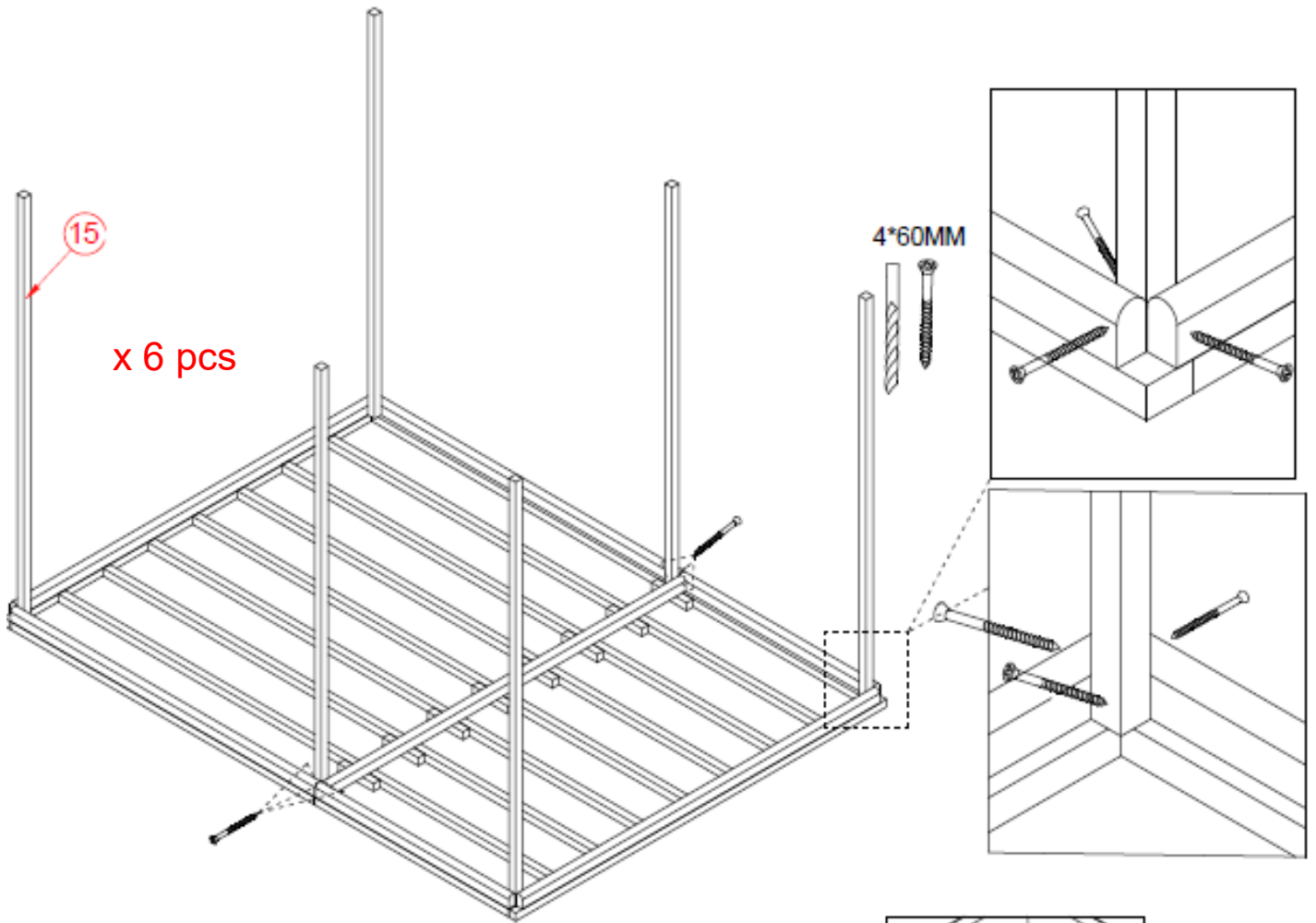

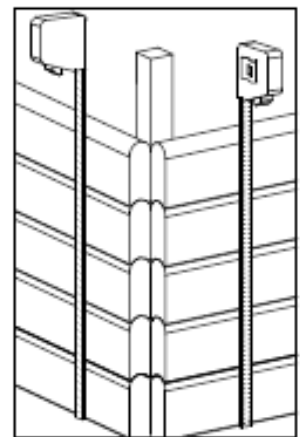
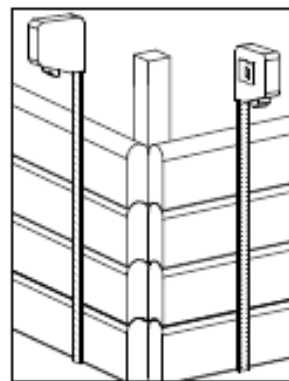
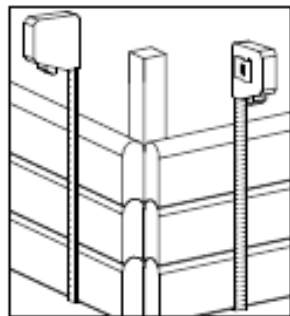
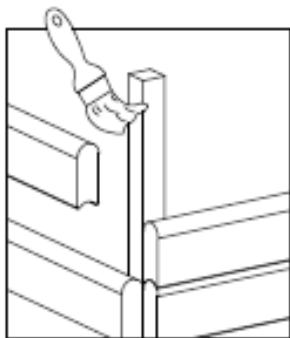
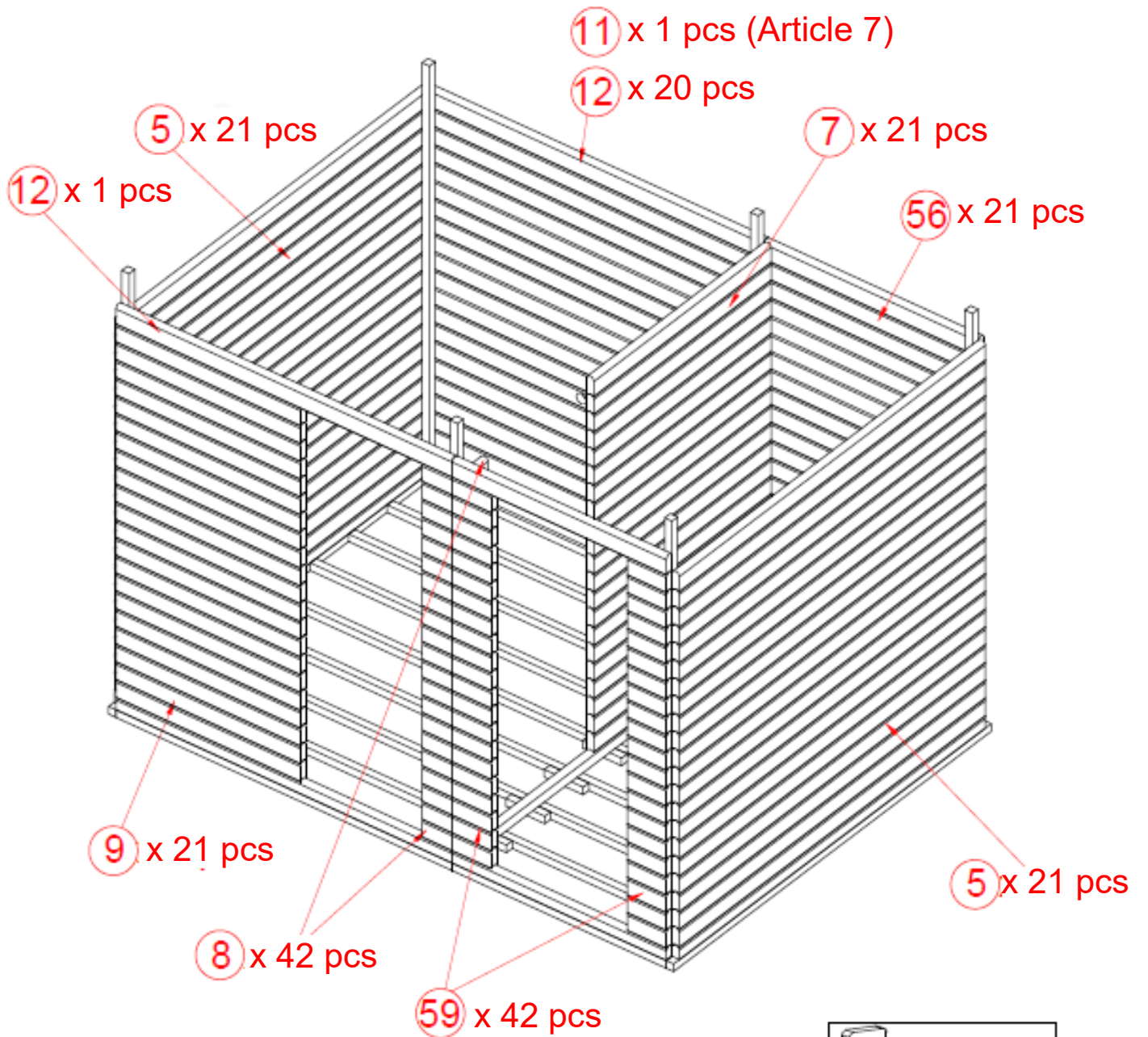

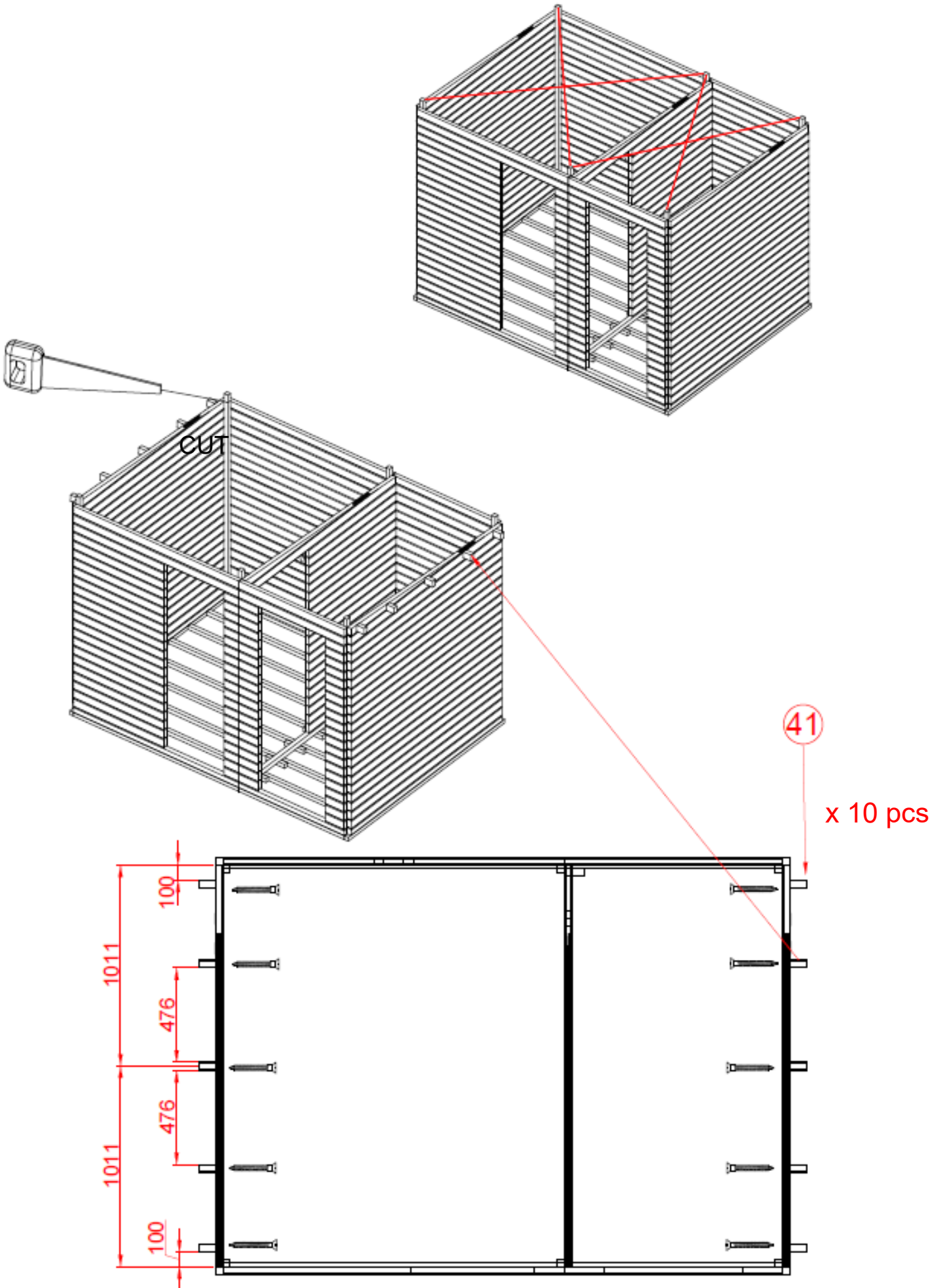

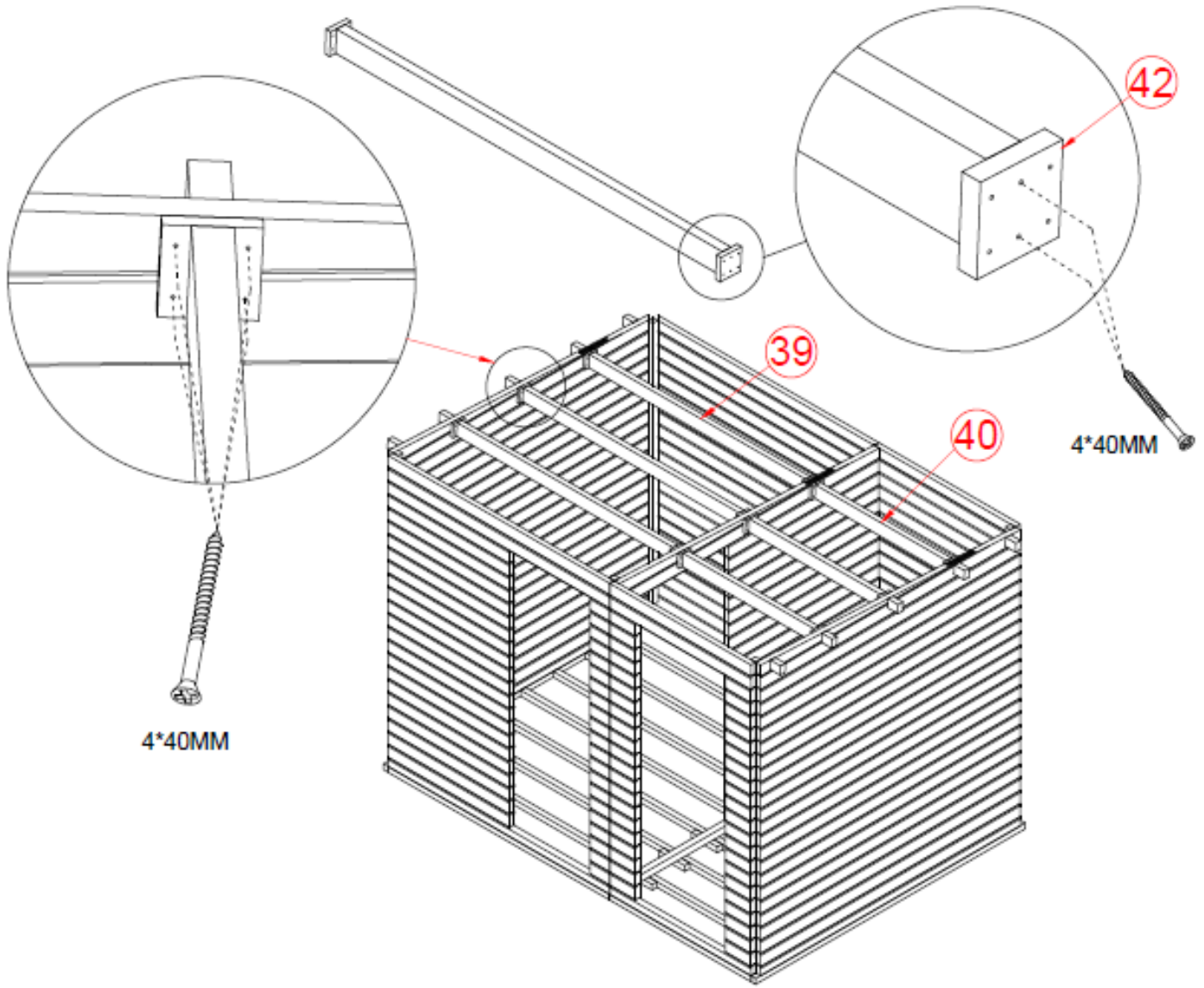

4*40MM

4*40MM

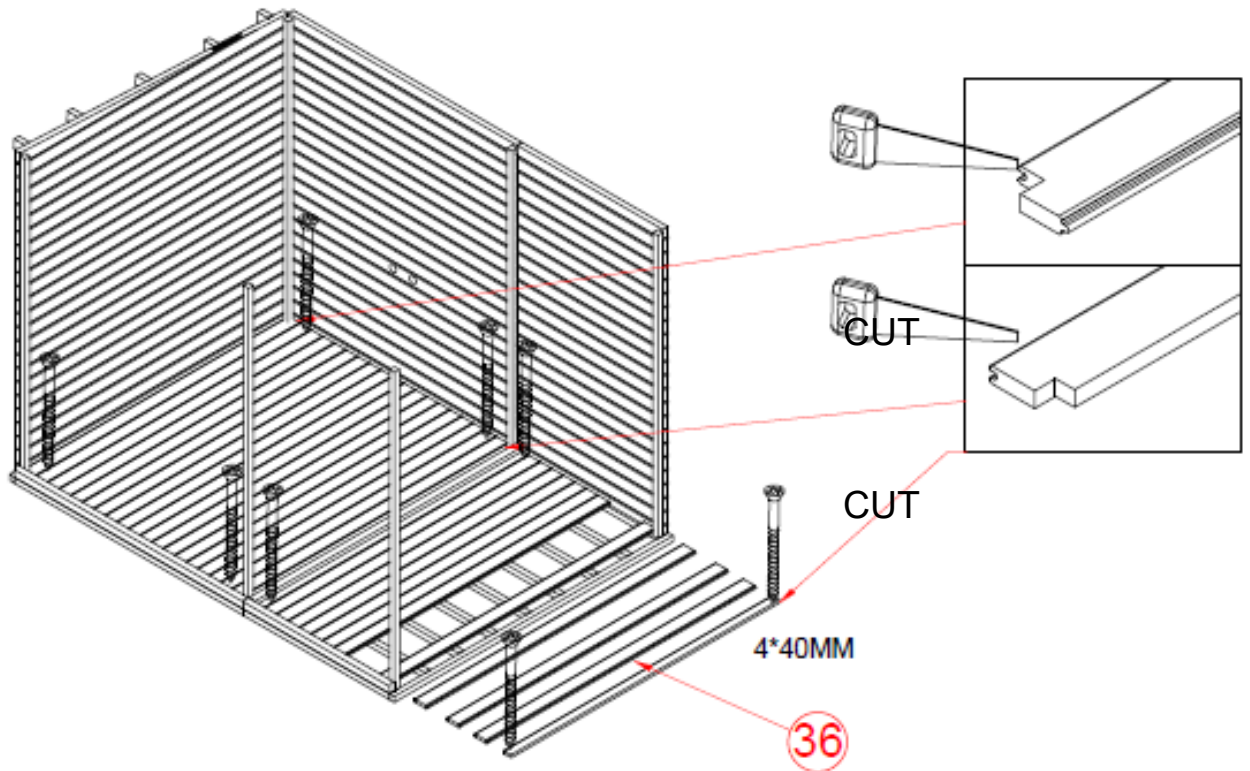

4*40MM

36

CUT

CUT

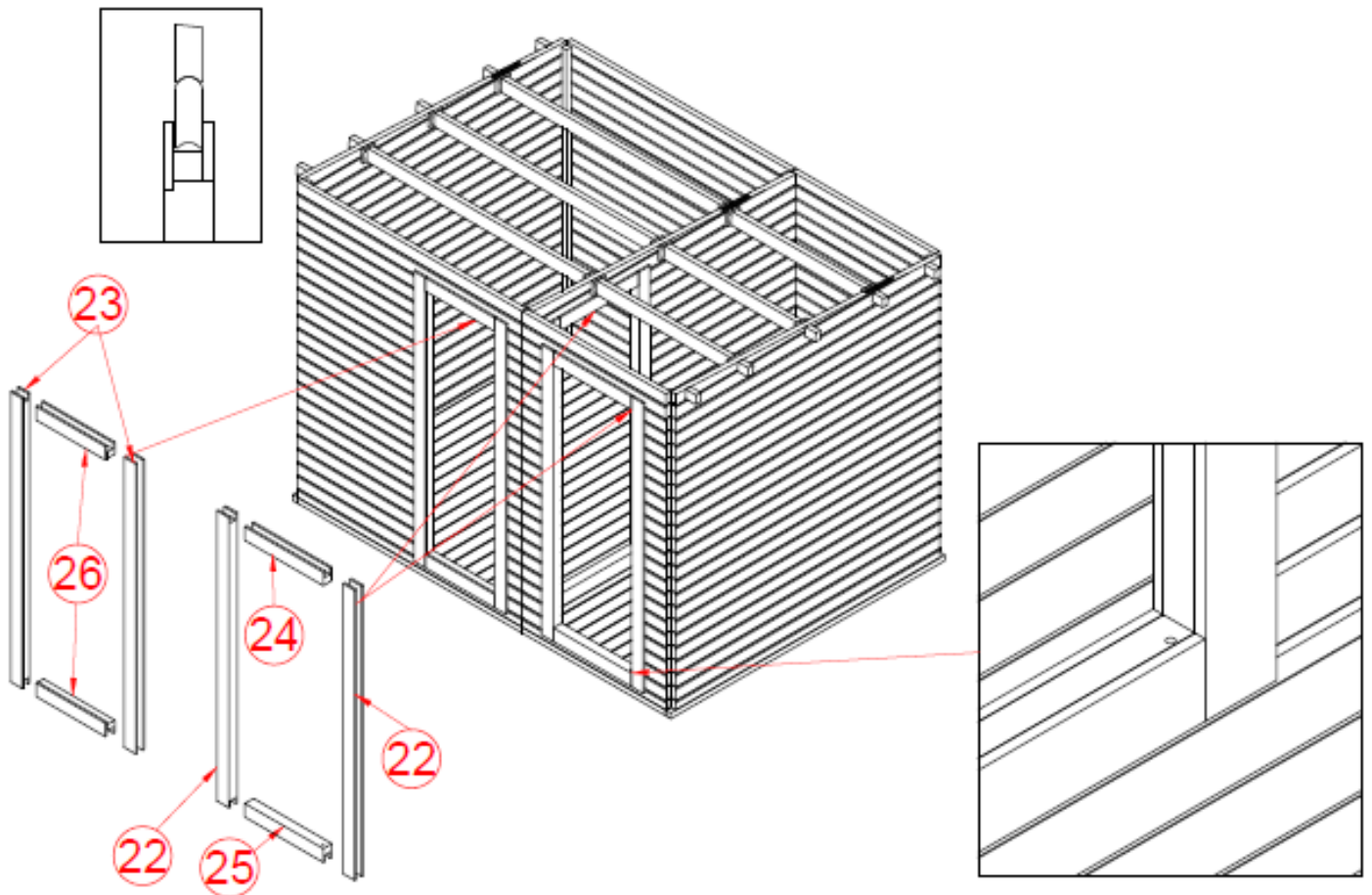
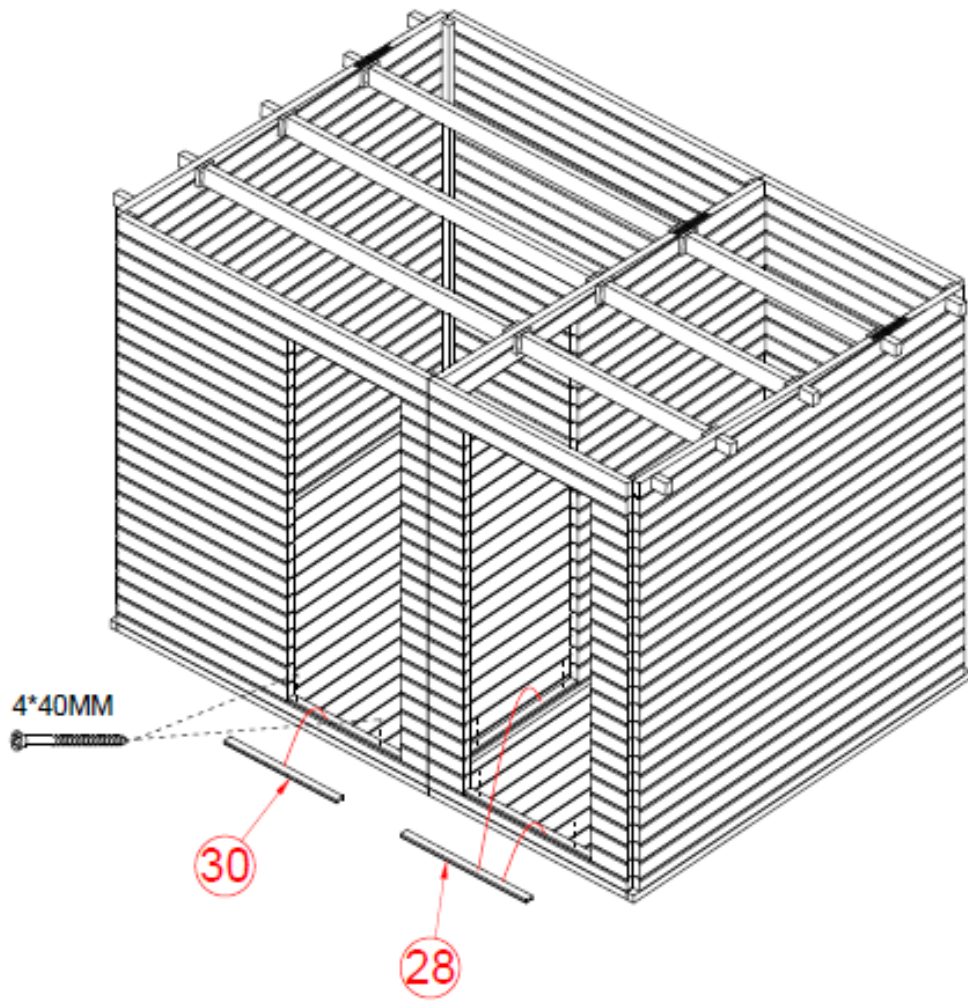

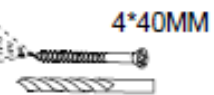
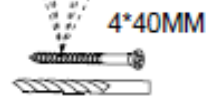
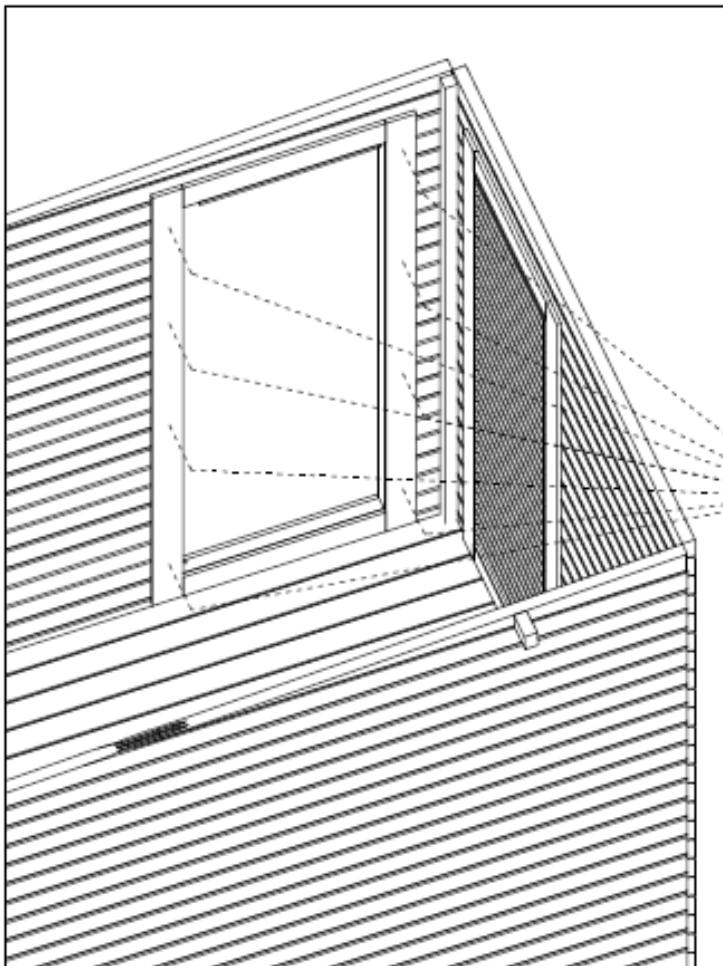
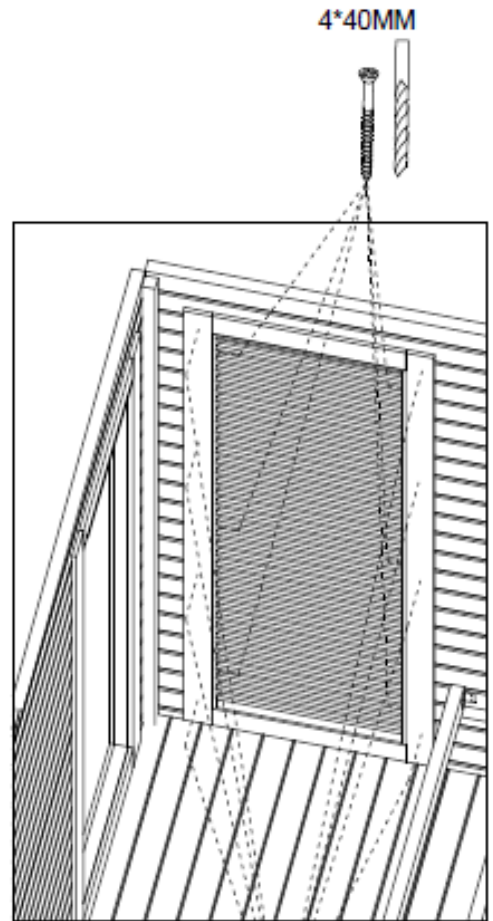
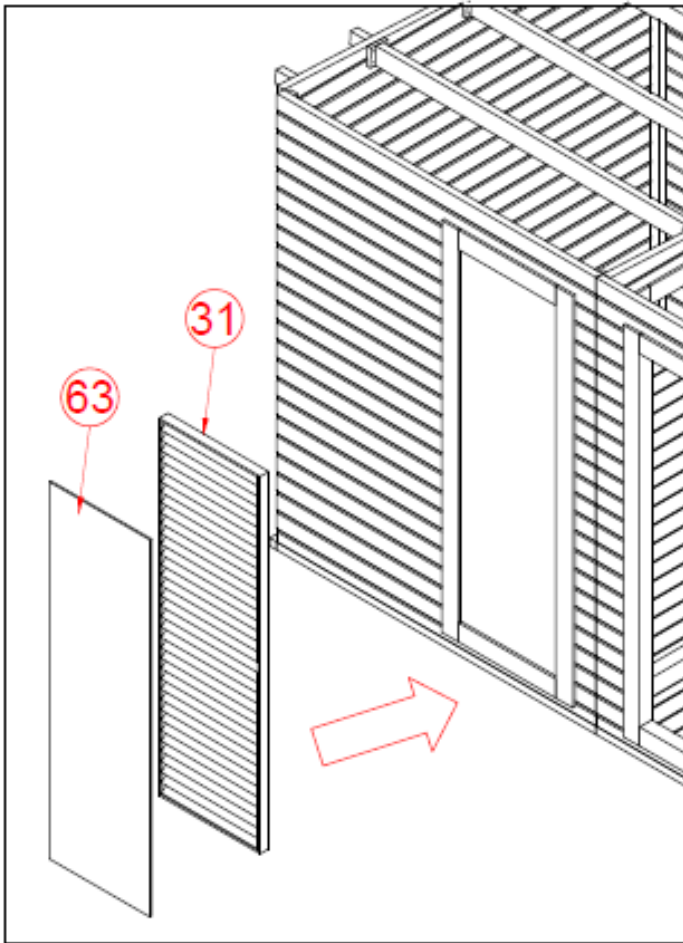

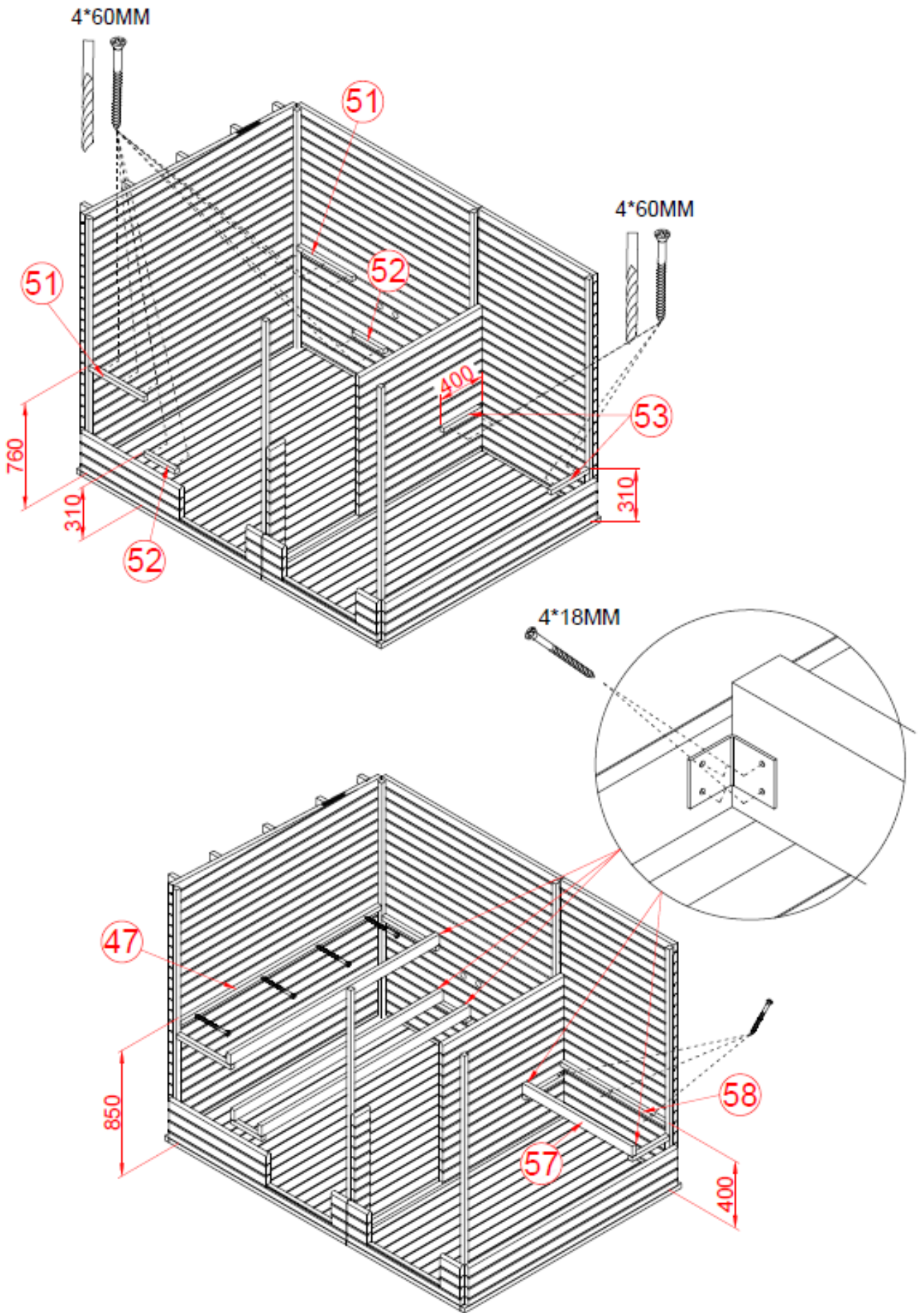

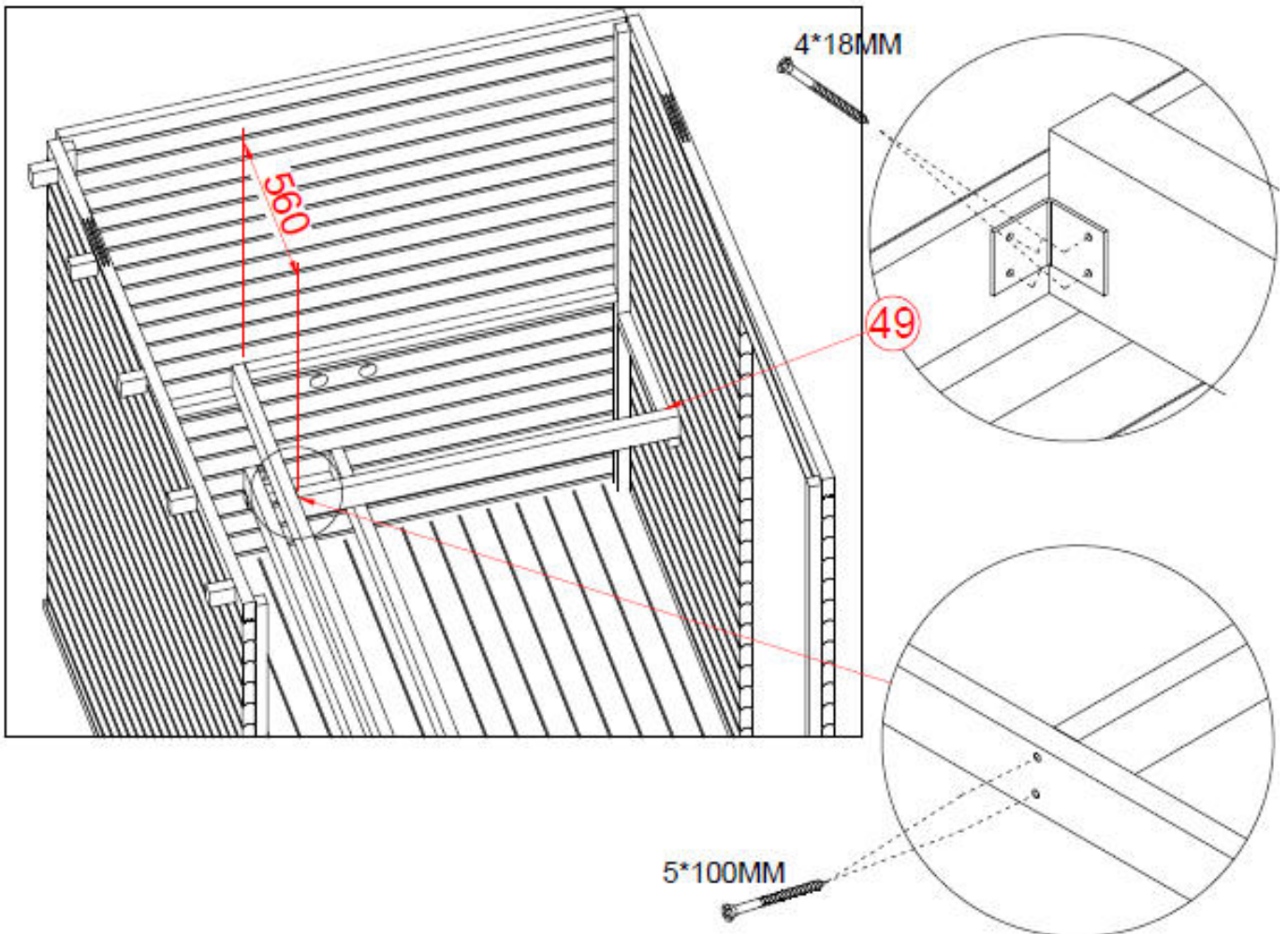
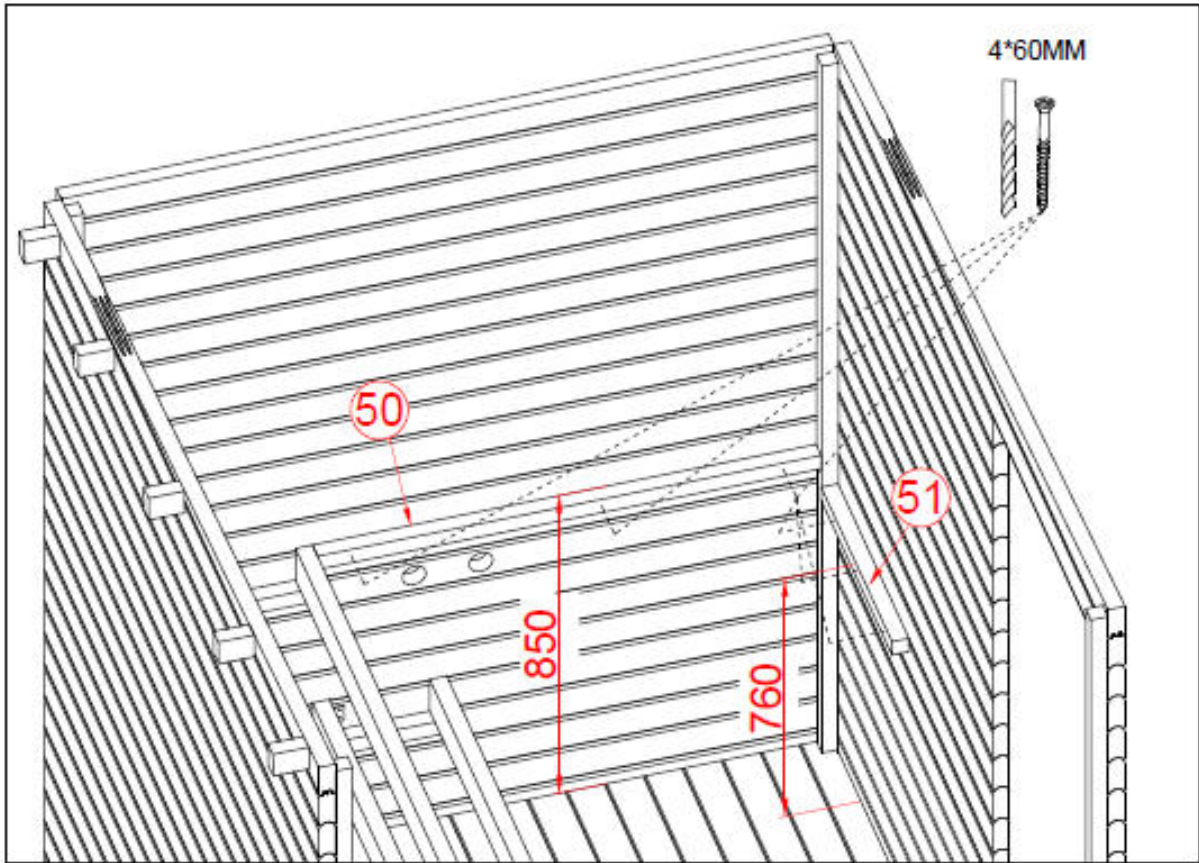

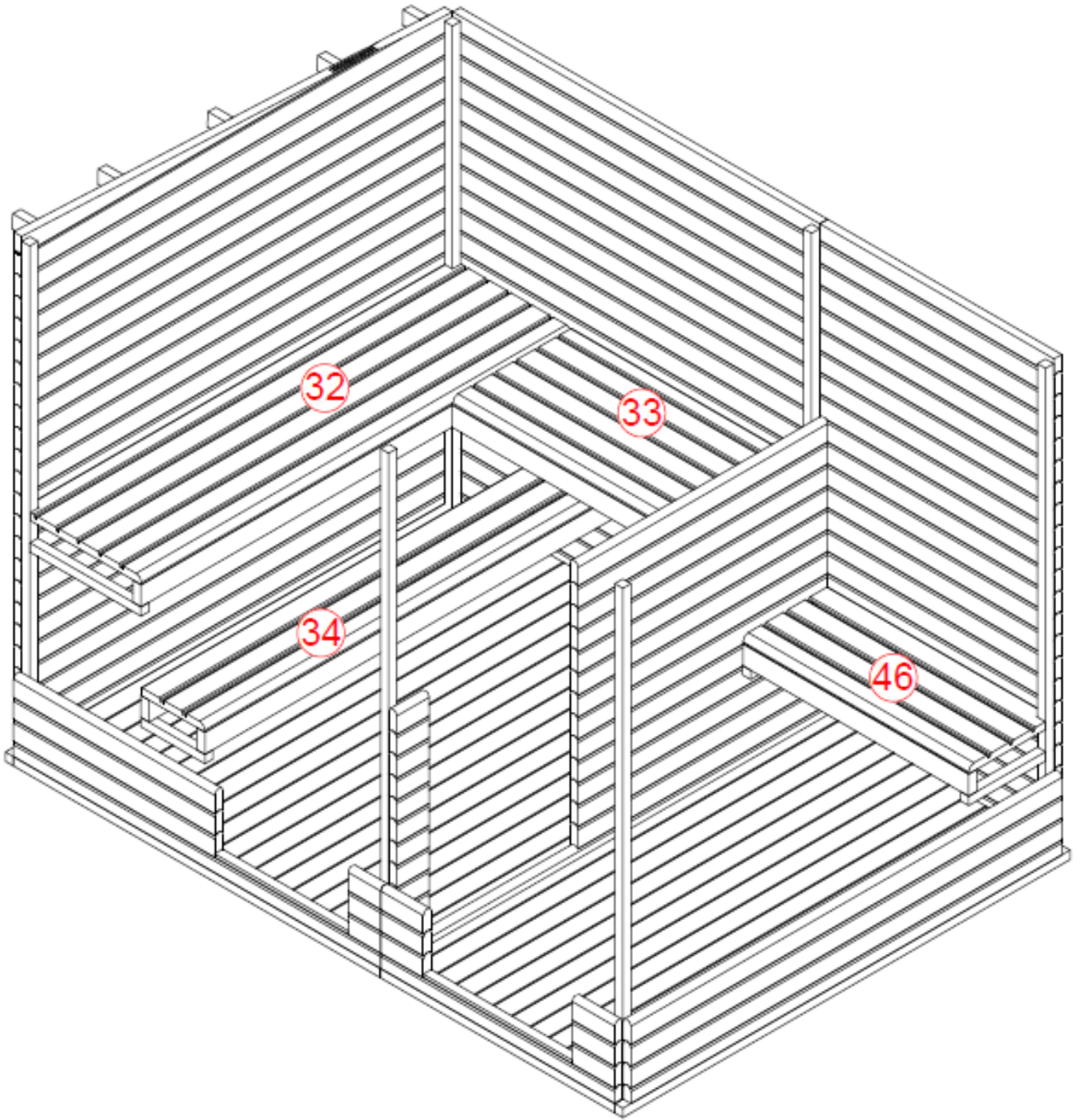

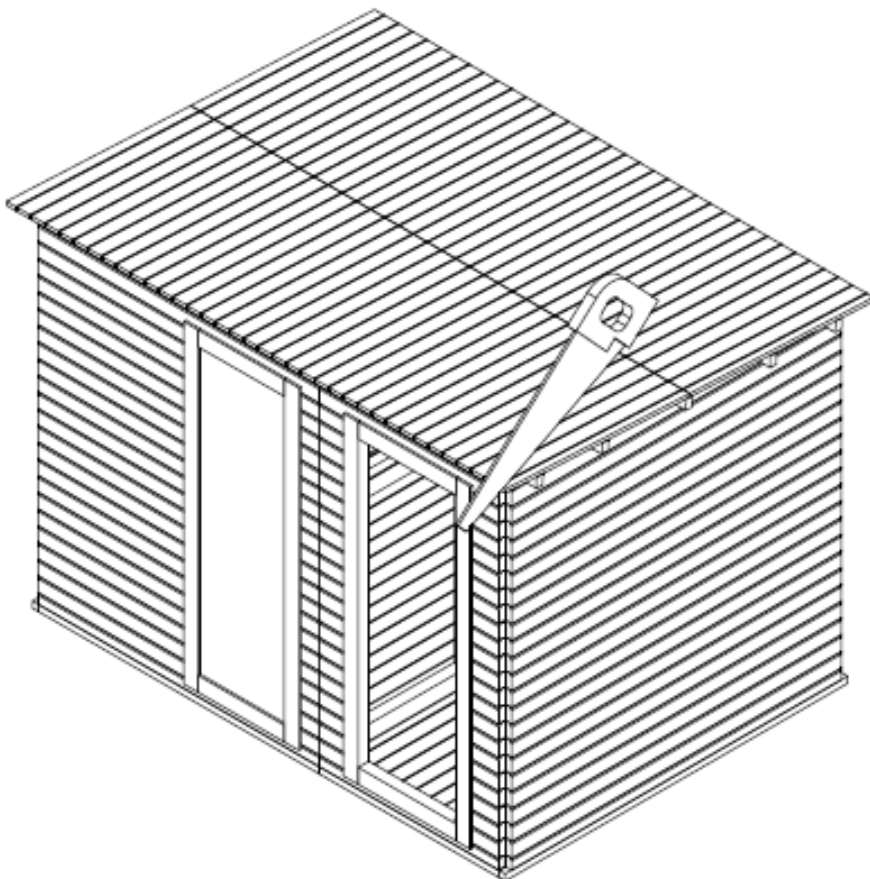
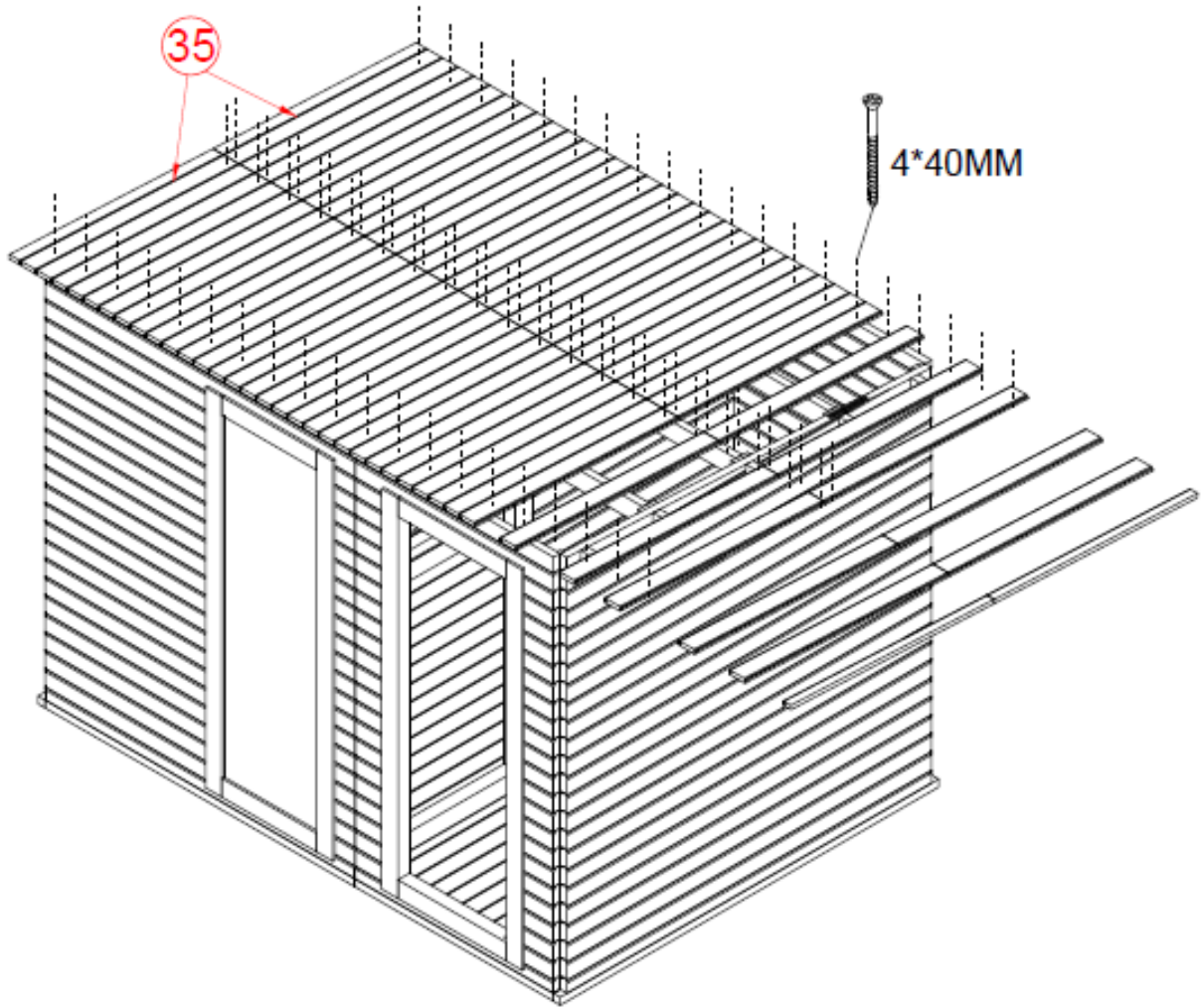

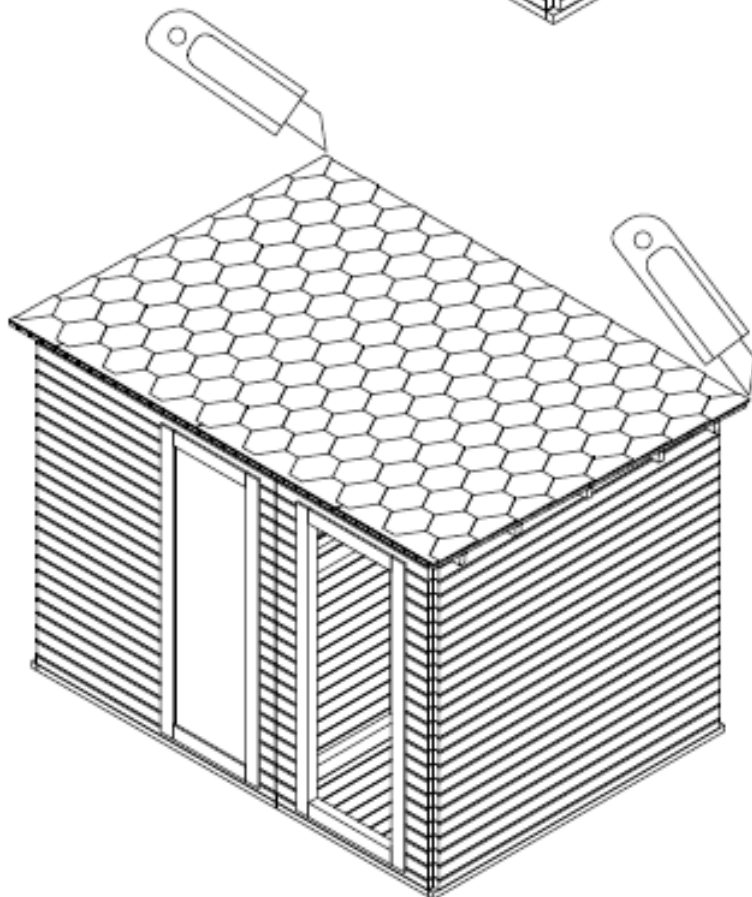
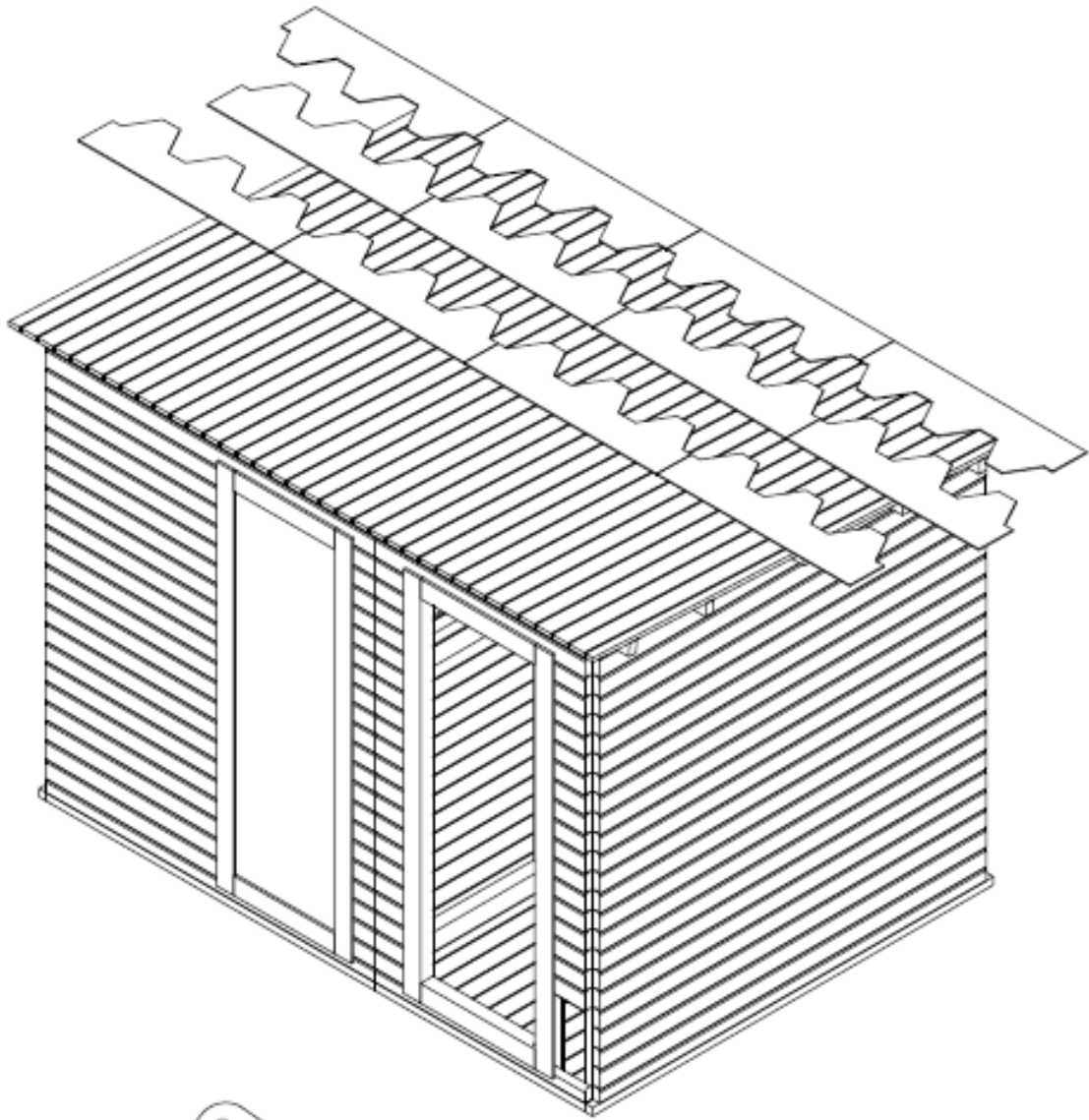

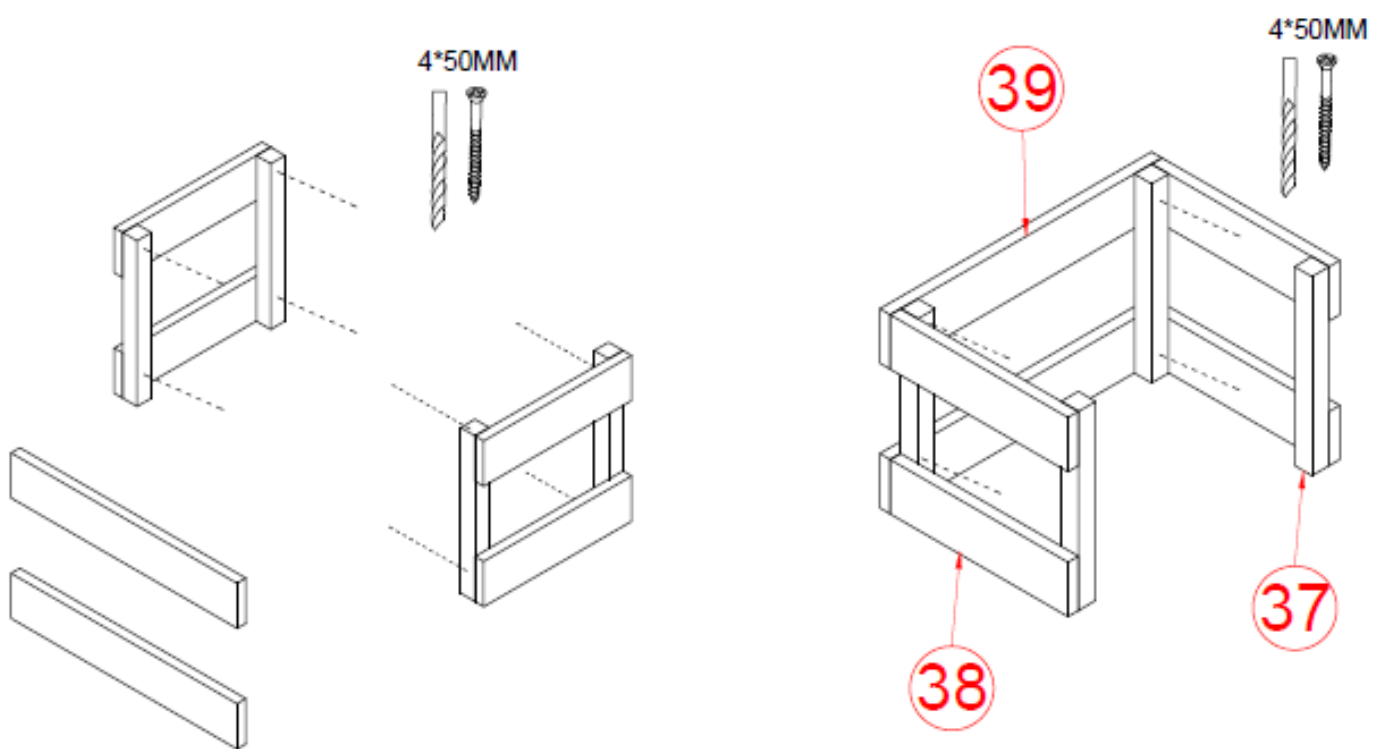
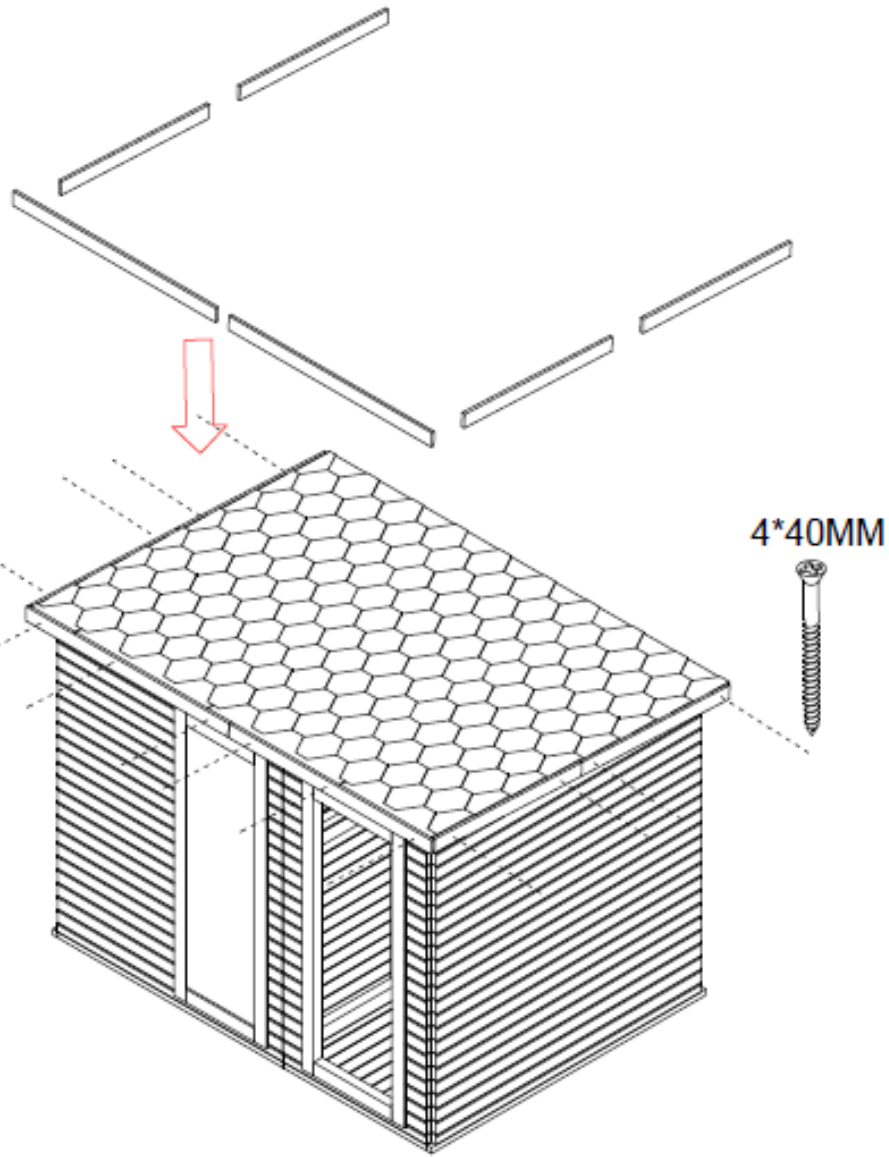

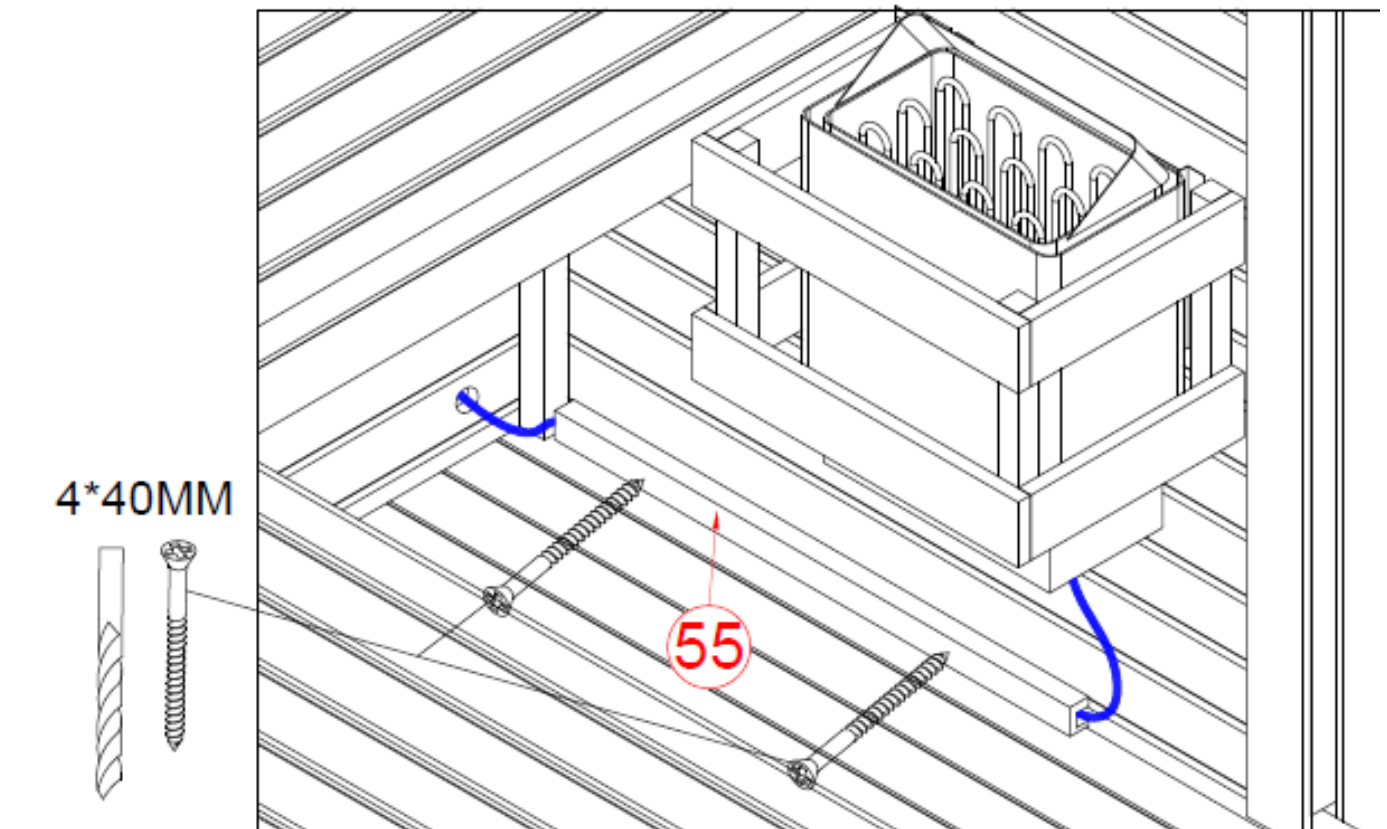
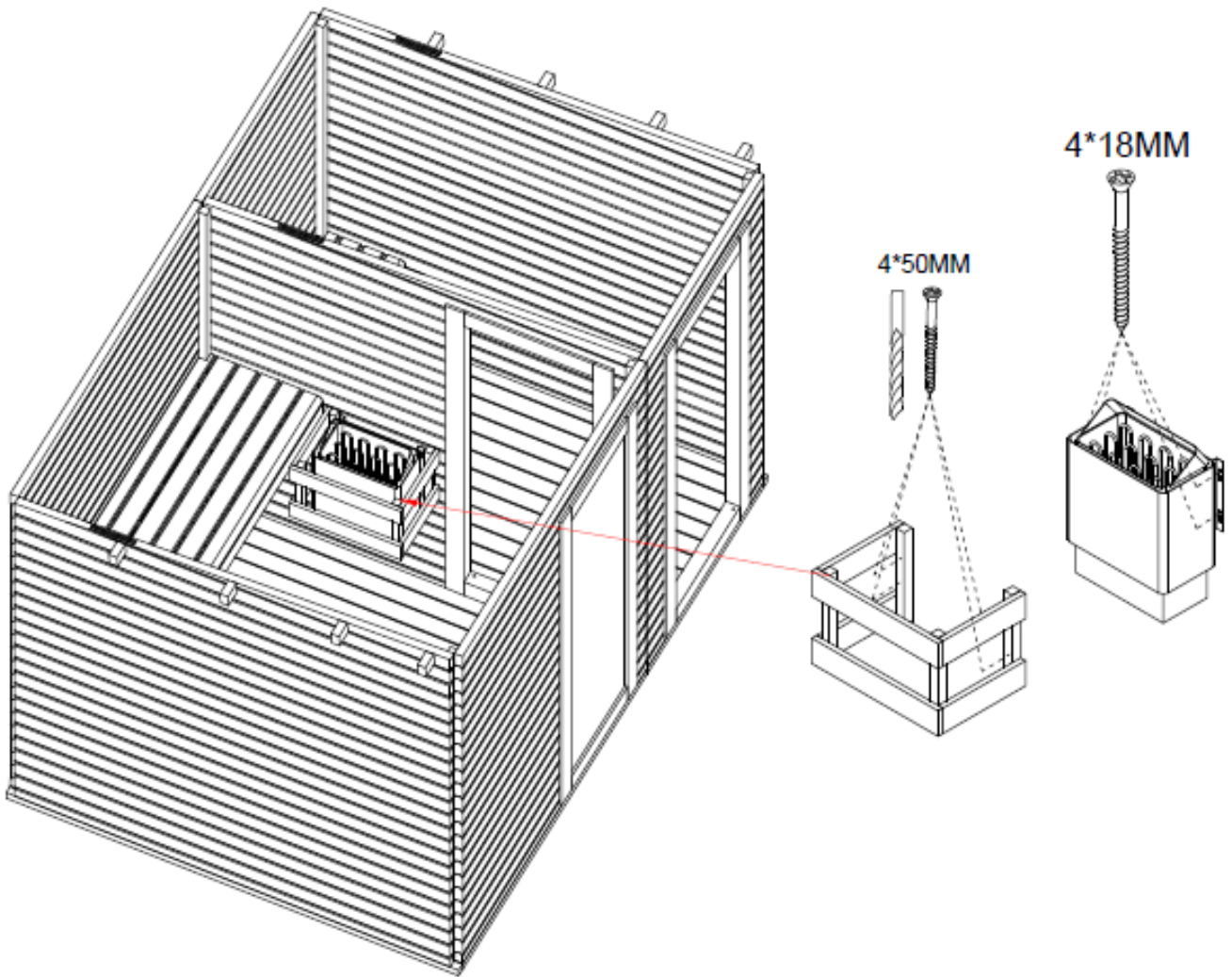

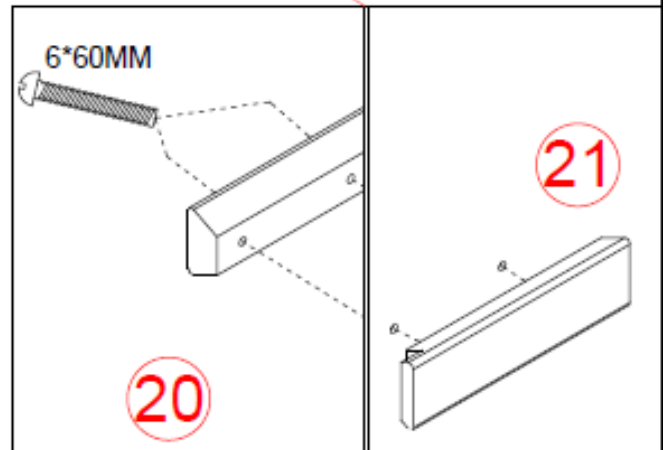
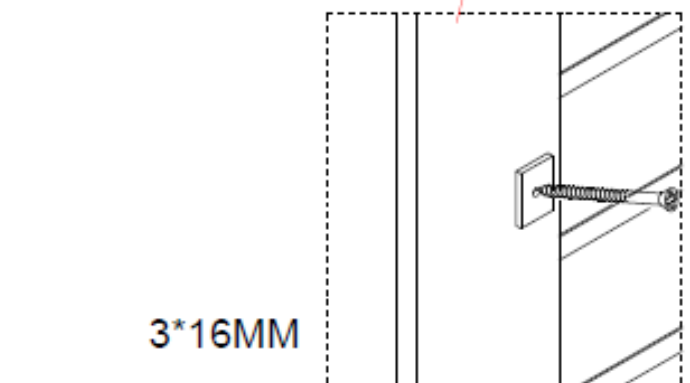
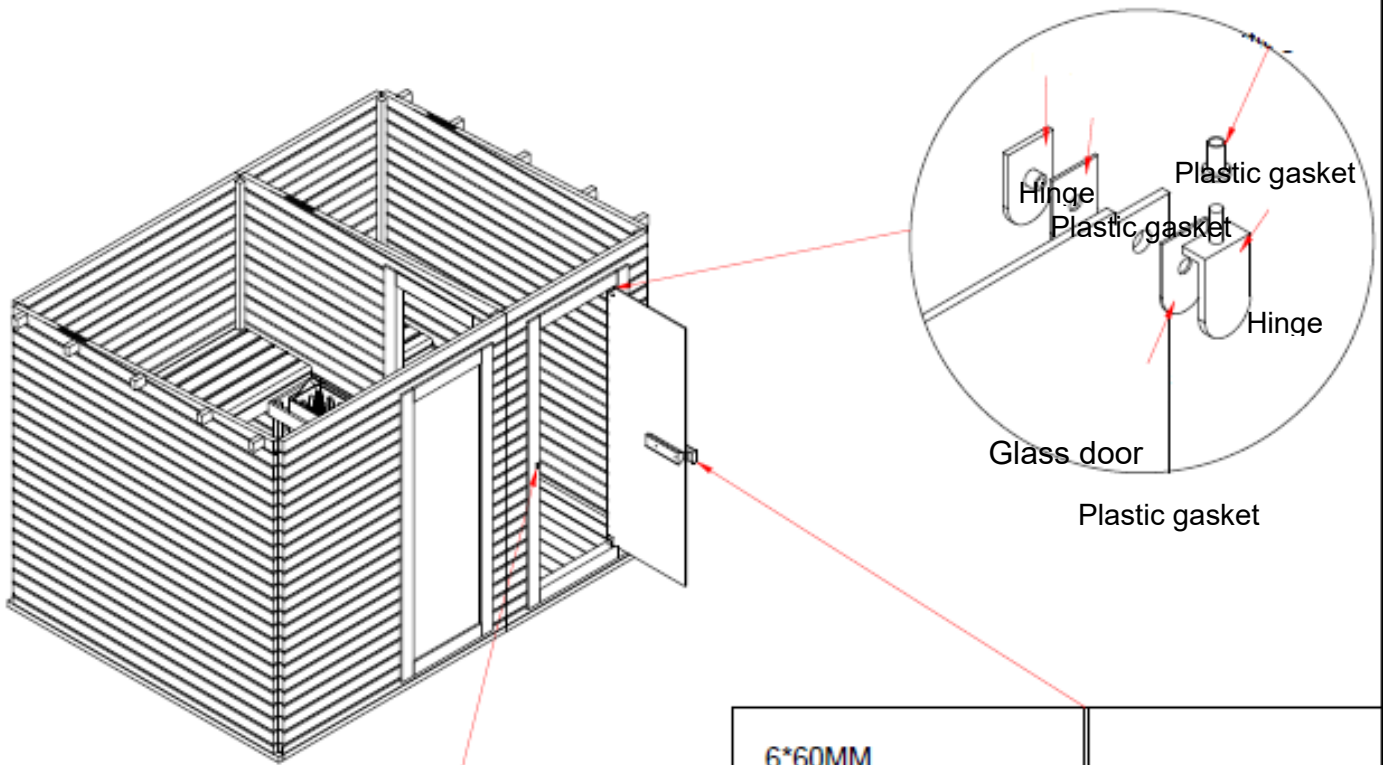
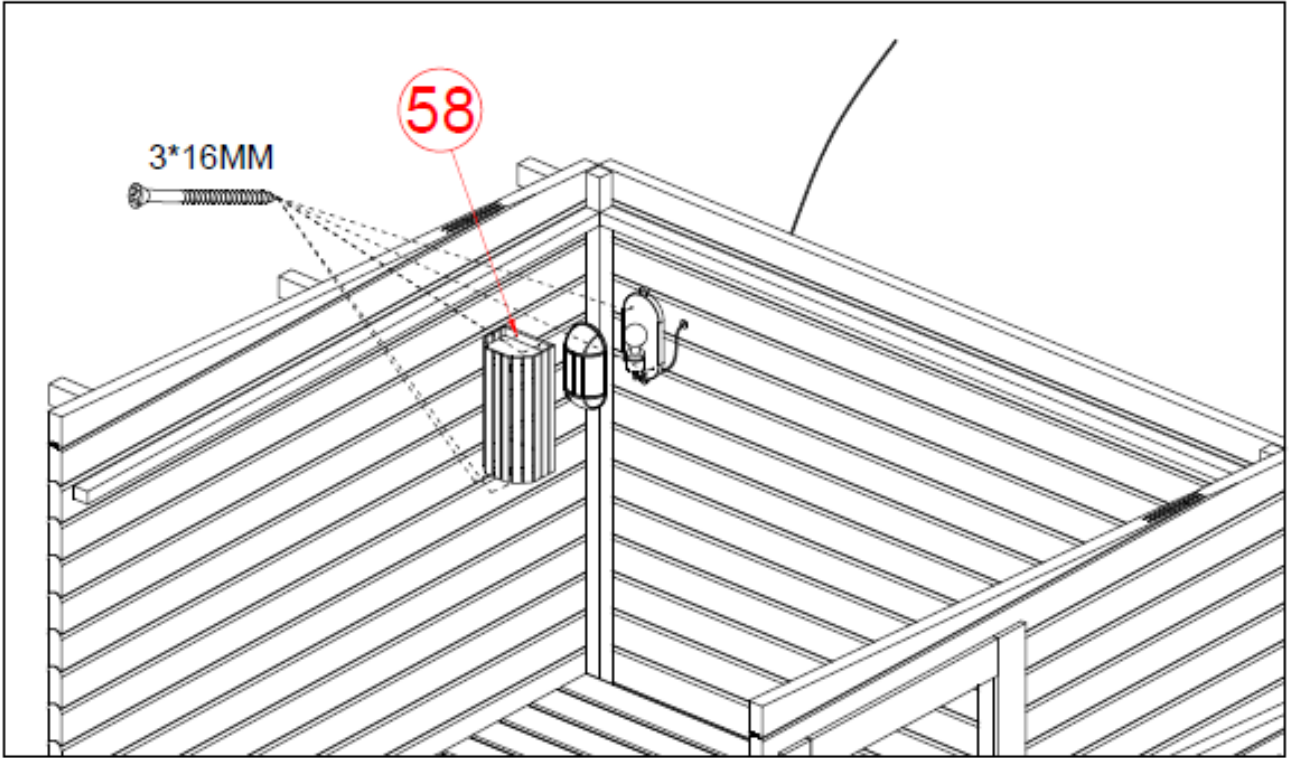

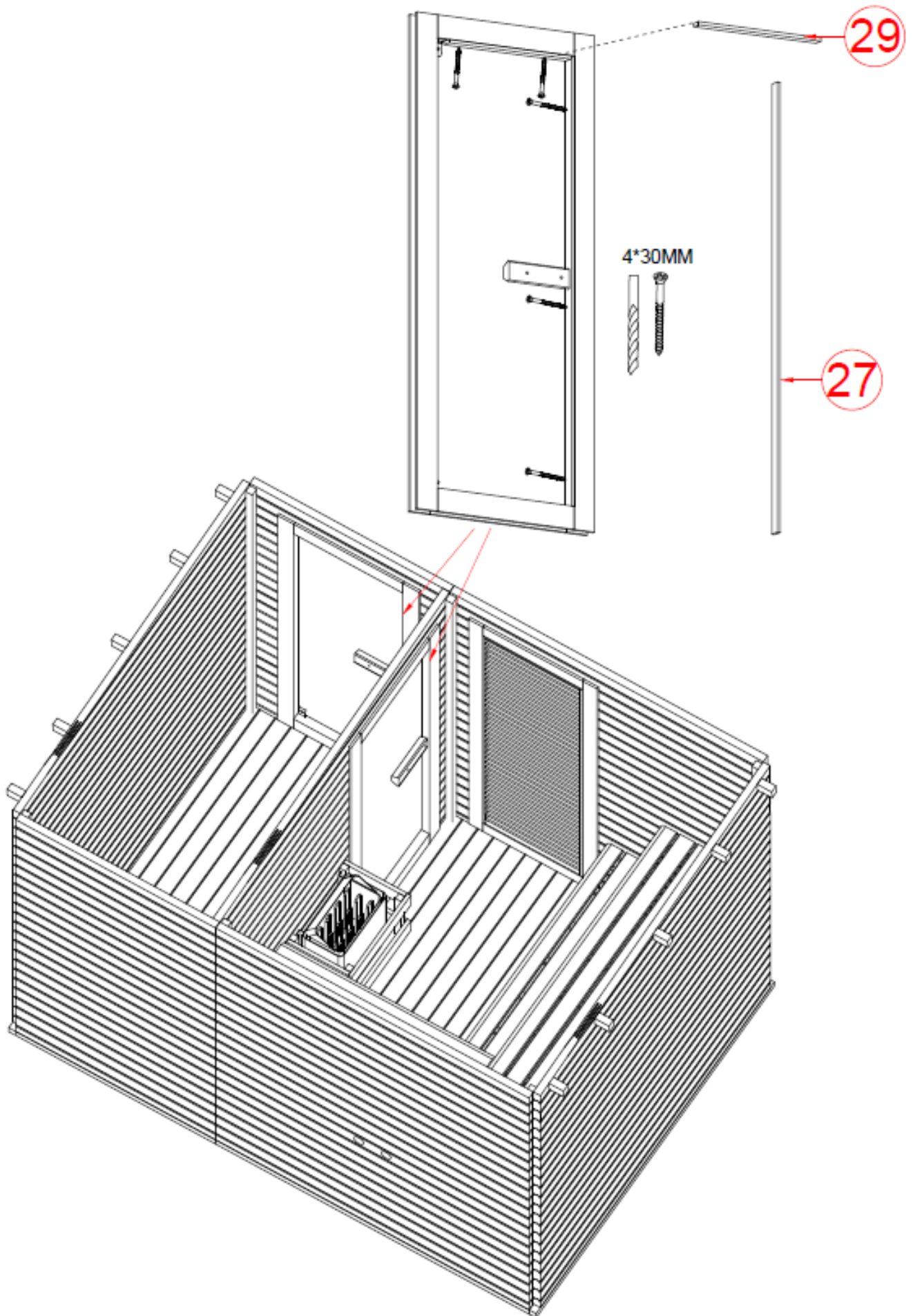

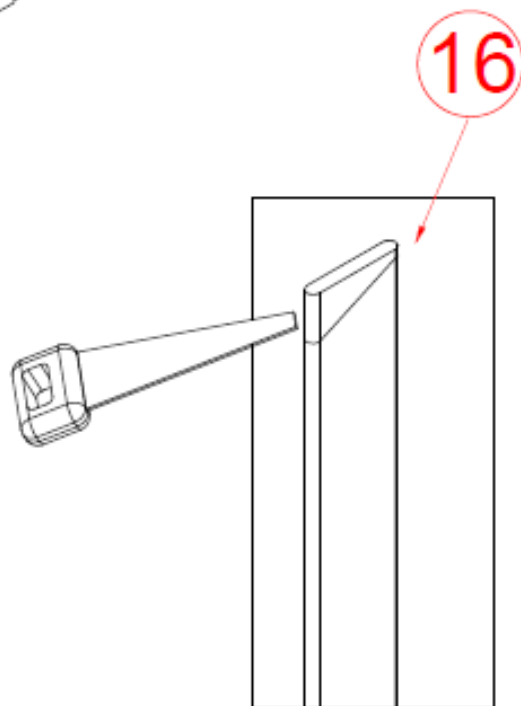
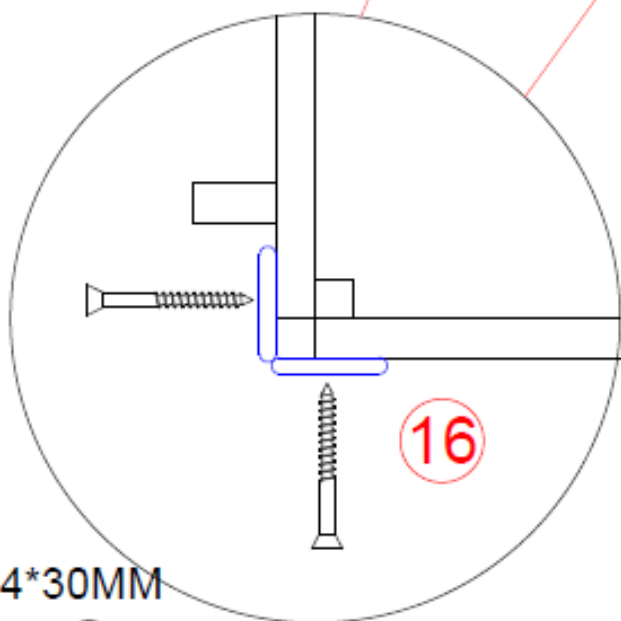
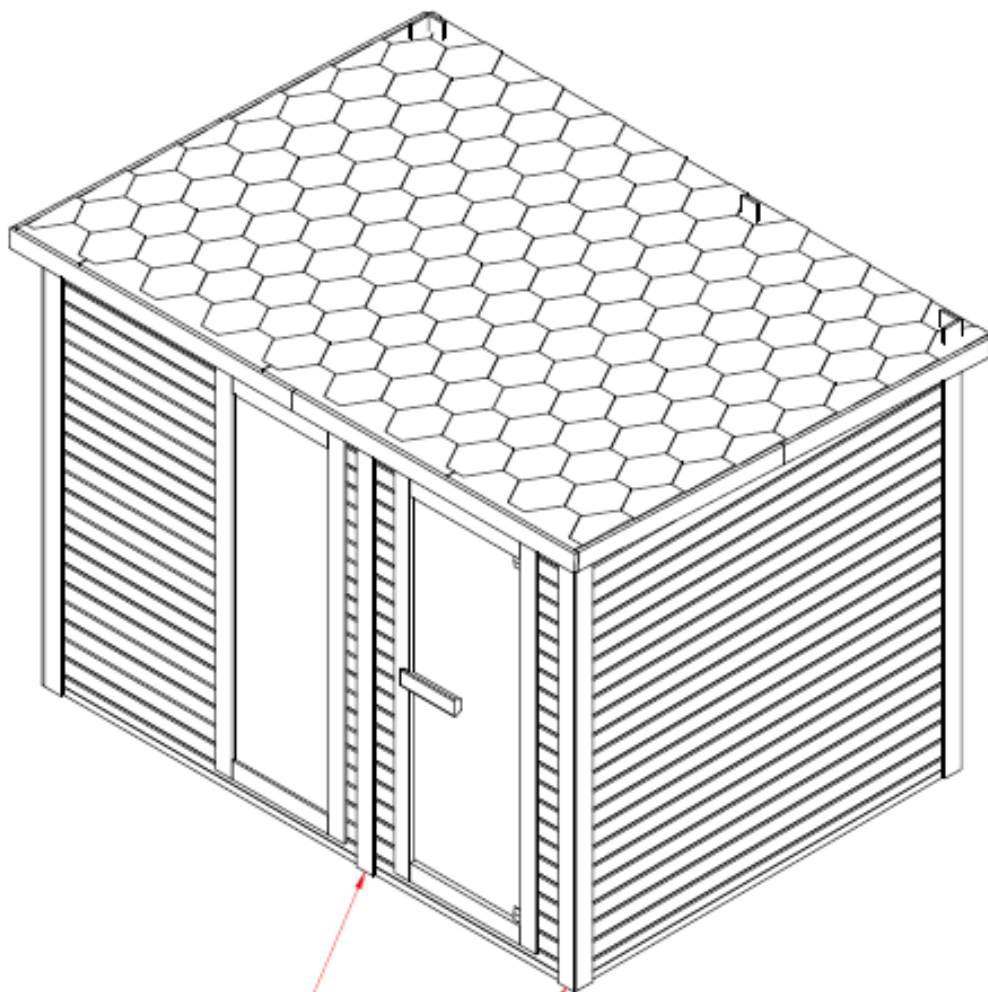

4*30MM

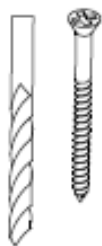

F30310

Инструкция за монтаж

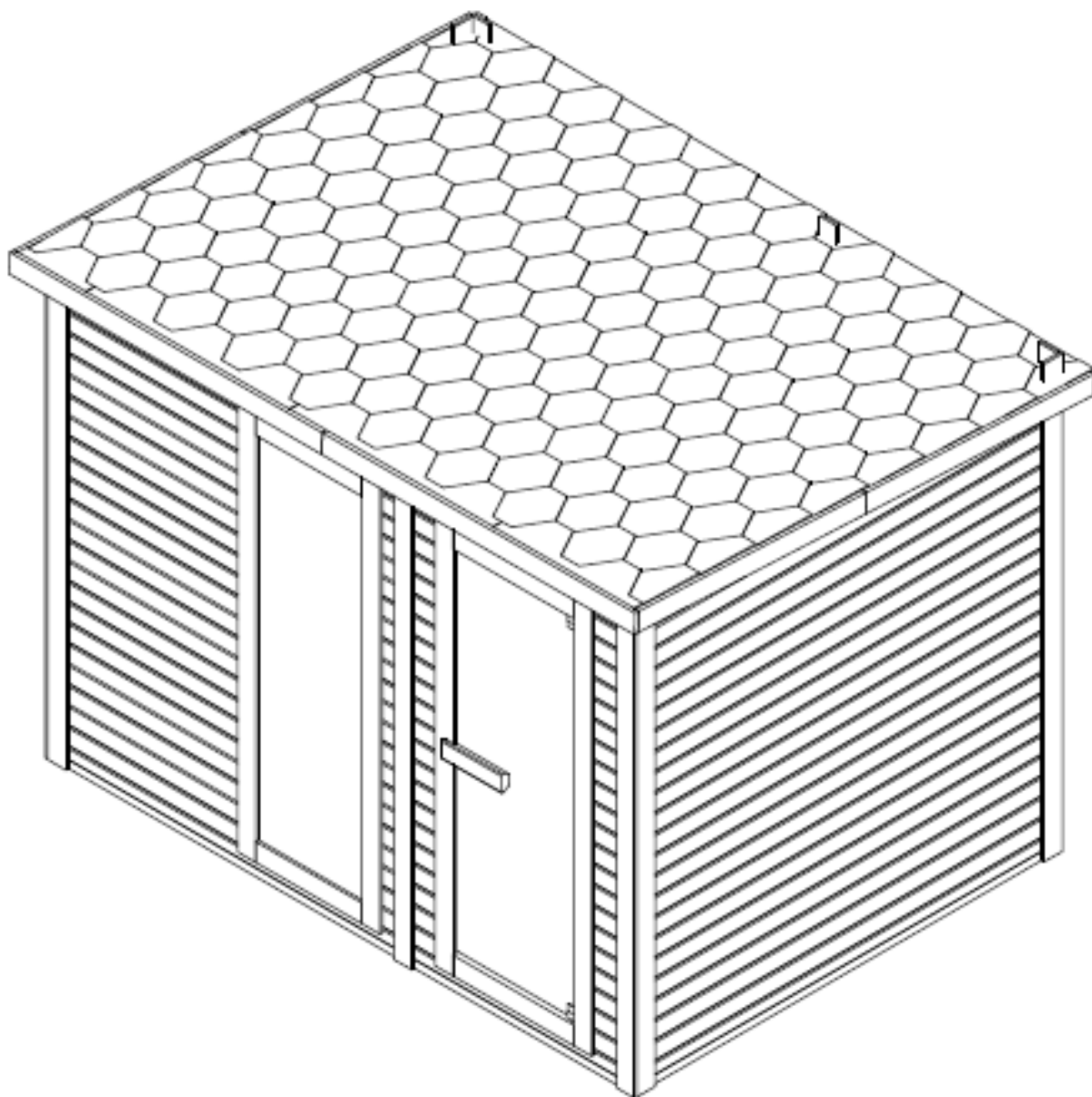

Внимание

Прочетете внимателно тези инструкции, преди да използвате вашата сауна за първи път.

Препоръчваме ви да съхранявате инструкцията, за да може да я използвате отново.

Моля, запишете серийния номер на контролната кутия на кабината, тъй като този номер ще бъде необходим в случай на ремонт или поръчка на резервни части.

- Дървото е жив елемент. За да запазите първоначалния му вид, е важно да обработите външната страна на дървото срещу влага.
- Поставете сауната върху идеално равна и твърда повърхност.
- Не използвайте течни почистващи препарати. Изключете сауната преди почистване и използвайте влажна кърпа.
- Защитете захранващия кабел на сауната, така че да не бъде смачкан или прищипан.
- Преди да смените определени компоненти, уверете се, че те са предписани от производителя или имат същите свойства като оригиналните части. Неправилната подмяна може да причини пожар, късо съединение или повреда на сауната. Горещо препоръчваме да се консултирате с квалифициран техник.
- За да избегнете риска от изгаряне или токов удар, не използвайте метални инструменти.
- В сауната не трябва да се въвеждат животни.
- Не оставяйте сауната включена без надзор.
- Не оставяйте сауната включена за повече от 1 час наведнъж, за да избегнете преждевременна повреда на уреда. Изключете сауната за поне 30 минути след 1 час непрекъсната работа.
- Препоръчително е да не монтирате заключваща система на вратата на сауната.
- Преди да свържете сауната към електрозахранването, проверете дали вашата електрическа инсталация отговаря на изискванията.
- Монтажът и ремонтите могат да се извършват само от квалифициран електротехник!
- Използвайте само оригинални части.
- Изключвайте сауната, когато не я използвате.

ОПАСНОСТ

- Покриването на агрегата води до опасност от пожар поради прегряване. Не покривайте нагревателните елементи!
- Винаги дръжте запалими или силно запалими материали/предмети (напр. кърпи) далеч от нагревателя.
- Не докосвайте нагревателя по време и малко след употреба, тъй като има риск от изгаряне от горещите части.
- Електрическата крушка се нагрява по време на работа. Ако електрическата крушка трябва да бъде сменена, изключете нагревателя от купето и оставете електрическата крушка да изстине
- охладете, преди да го смените.

Безопасност

Важно !

Моля, прочетете внимателно инструкциите за безопасност, преди да настроите и използвате вашата сауна. Инструкциите са важни за вашата безопасност, така че, моля, спазвайте ги стриктно.

Бъдете нащрек за хипертермия, топлинен удар или топлинно изтощение, които могат да бъдат причинени или влошени от неспазване на инструкциите за безопасност. Симптомите включват висока температура, ускорен пулс, замаяност, припадък, летаргия и изтръпване в цялото или в части от тялото. Ефектите са: намалено усещане за топлина, непознаване на предстоящите опасности, загуба на съзнание.

Внимавайте за хипертермия, топлинен удар или топлинно изтощение, които могат да бъдат причинени или влошени от неспазване на инструкциите за безопасност. Симптомите включват висока температура, ускорен пулс, замаяност, припадък, летаргия и изтръпване в цялото тяло или в части от тялото. Ефектите са: намалено усещане за топлина, липса на съзнание за надвиснала опасност, загуба на съзнание.

Сауната не може да се използва от:

- Деца под 6 години.
- Хора със силни реакции към слънчева светлина.
- Хора с предшествали заболявания като сърдечни заболявания, високо или ниско кръвно налягане, нарушения на кръвообращението или диабет без предварителен медицински съвет.
- Бременни жени. Прекомерната температура може да застраши плода.
- Хора, страдащи от дехидратация, отворени рани, очни заболявания, изгаряния или слънчев удар.

Деца на възраст от 6 до 16 години могат да използват сауната, при условие че са постоянно наблюдавани от отговорен възрастен и температурата не надвишава 60°C.

Ако имате здравословни проблеми, приемате лекарства или имате наранени мускули или връзки, можете да използвате сауната само след предварителна консултация и одобрение от лекар.

Ако имате хирургически импланти, не можете да използвате сауната, без първо да се консултирате с лекар и да получите неговото одобрение.

Не използвайте сауната след усилена дейност. Изчакайте 30 минути, докато тялото ви се охлади.

Не прекарвайте повече от 40 минути наведнъж в сауната.

Не употребявайте алкохол или наркотици преди или по време на сесията.

Не спете в сауната, когато работи.

За да избегнете риска от прегряване, включете сауната си в достатъчно мощен контакт и не свързвайте никакви други електрически уреди към същия контакт.

За да избегнете риска от токов удар или повреда на сауната, тя не трябва да се използва:

- По време на гръмотевична буря.
- Ако електрическият кабел е повреден, той трябва да бъде заменен от квалифицирано лице.
- Ако захранващият кабел прегрее, той трябва да бъде проверен от квалифицирано лице.
- Ако трябва да смените електрическа крушка, изчакайте сауната да се изключи и да се охлади.
- Подсушете ръцете си, преди да свържете или изключите захранването.

Никога не работете с мокри ръце или крака.

Не включвайте или изключвайте бързо захранването или отоплението, тъй като това може да повреди електрическата система.

Не се опитвайте да ремонтирате сауната сами без съгласието на търговеца на сауната или производителя.

Опитите за неоторизиран ремонт ще анулират гаранцията на производителя.

Не използвайте почистващи препарати в сауната.

Не натрупвайте и не съхранявайте никакви предмети във или върху сауната.

Не поставяйте никакви запалими материали или химически вещества в близост до сауната.

Не покривайте нагревателните елементи!





Не докосвайте нагревателя по време и малко след употреба, тъй като има риск от изгаряне поради горещите части.



Изключвайте кабината, когато не я използвате.

Технически данни:

Модел	F30310
Матриал	Смърч
Дълбочина	2300mm
Широчина	3100mm
Височина	2200mm
Напрежение	AC380V
Агрегат за сауна	8KW

Матриали за сглобяване

											
Ø3x16	Ø4x70	Ø4x60	Ø4x50	Ø4*40	Ø4*30	Ø4*18	Ø5*100	Ø6x60	Wood pad		
6x	103x	300x	76x	240x	62x	40x	2x	4x	2x	2x	4x

		
2x	10x	2x

Моля, отстранете транспортната опаковка и проверете дали вашата инфрачервена кабина е доставена цяла и неповредена, преди да започнете да я сглобявате.

Прочетете внимателно инструкциите за монтаж, преди да намерите подходящо място за вашата сауна. Сауната е предназначена само за външен монтаж.

Изберете област:

- На сухо място върху равна, стабилна повърхност, която може да издържи тежестта на вашата сауна.
- Височината трябва да е достатъчна, за да ви позволи да достигнете тавана и да извършите електрически връзки и работи по поддръжката.
- Пазете от източници на вода, пламъци или запалими материали.

Практически съвети

- Моля, имайте предвид, че са необходими най-малко 2ма възрастни за настройка на сауната.
- Идентифицирайте ясно всеки панел, преди да започнете
- Когато инсталирате, поставете захранващия кабел на вашата сауна така, че да е лесно достъпен.
- Моля, имайте предвид, че има разлики между моделите.

ВАЖНО:





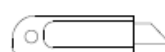
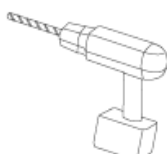
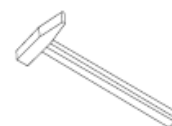
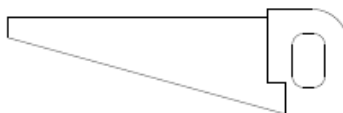
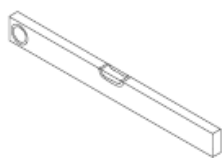



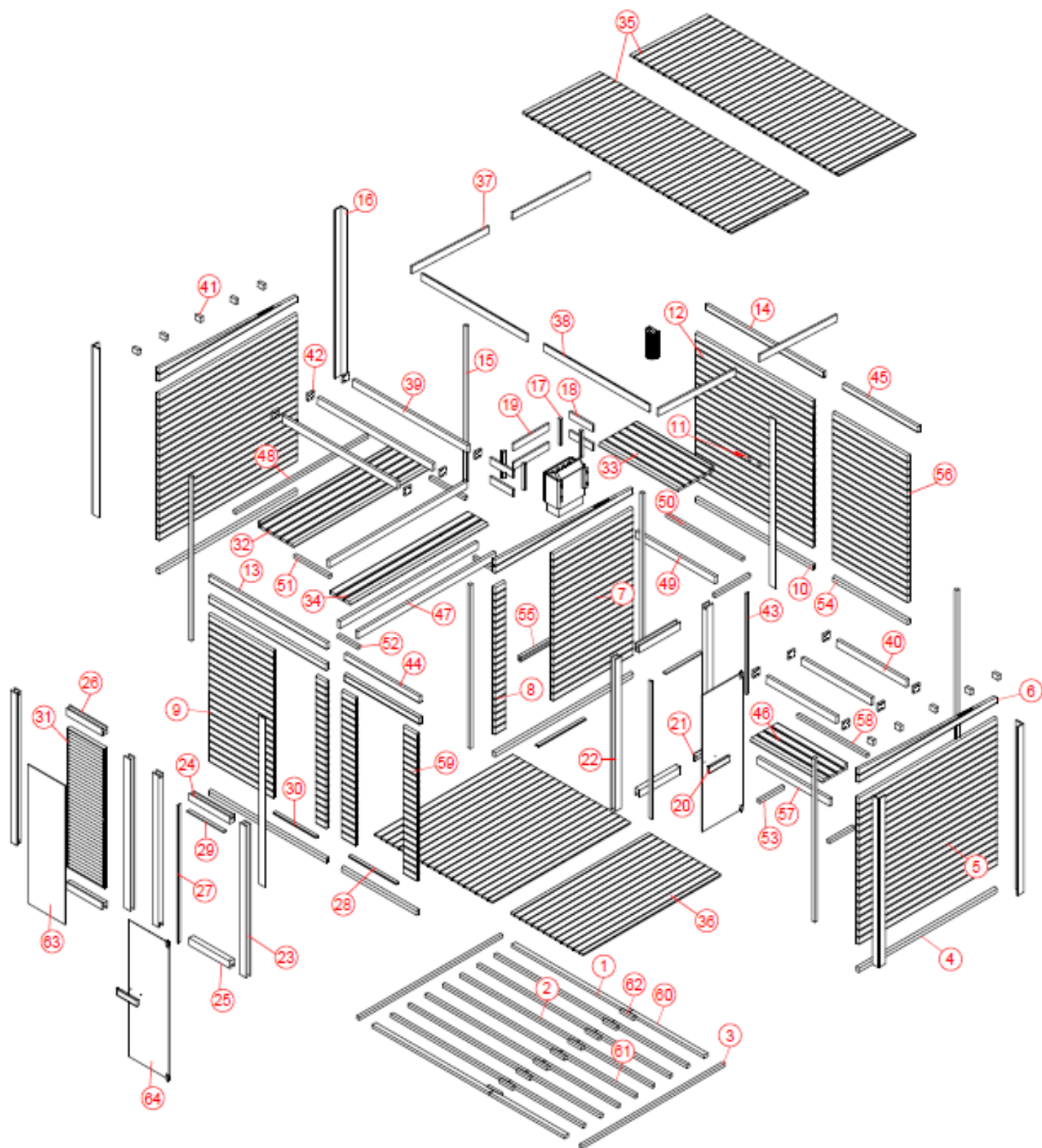

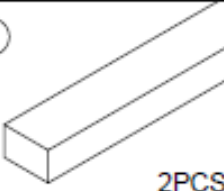
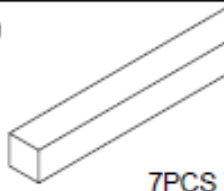
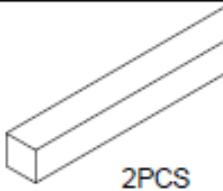
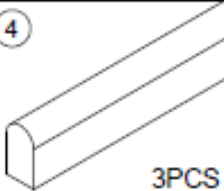
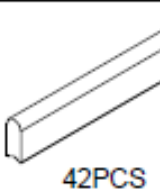

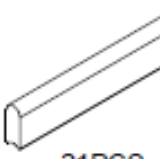

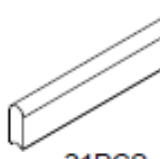
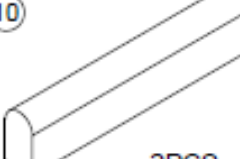
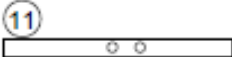
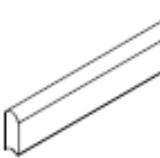



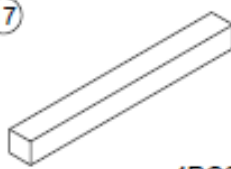

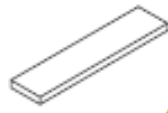
Моля, проверете zenкера и диаметъра на отворите, за да избегнете повреда на дървото.

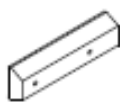
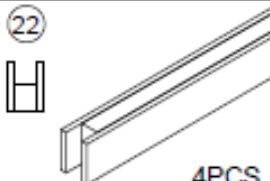
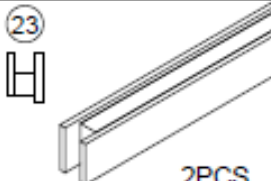
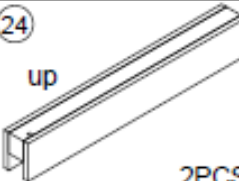
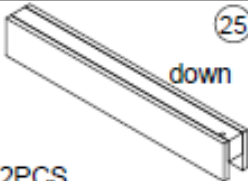
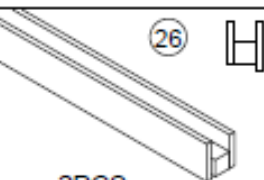
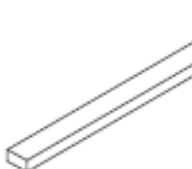
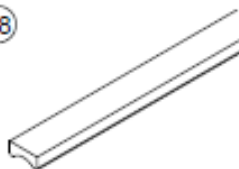

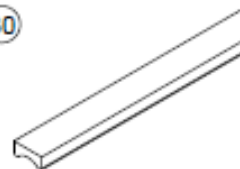

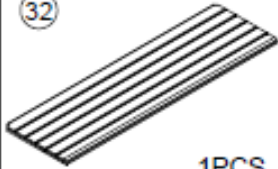
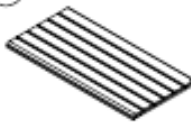

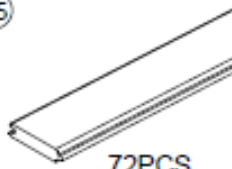
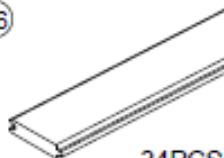

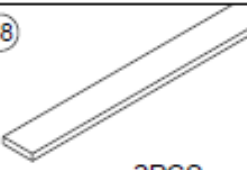
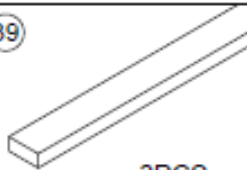
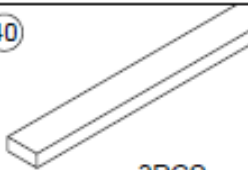



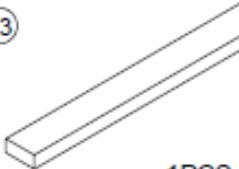

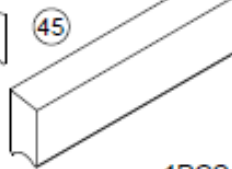
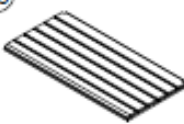
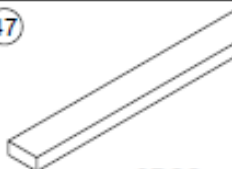
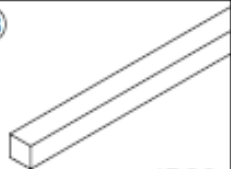

Инструменти:

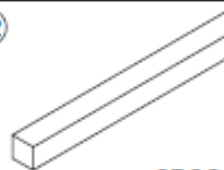
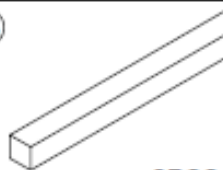

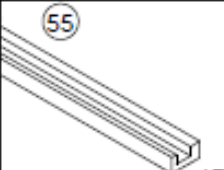
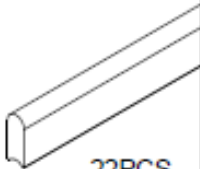
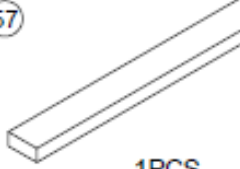
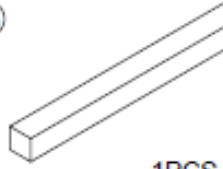
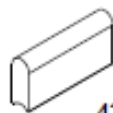
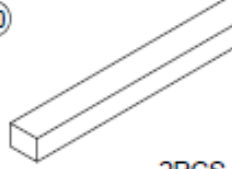
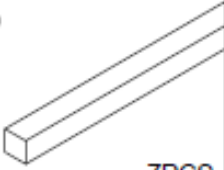
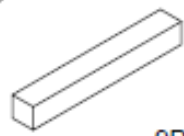
Части:



①  2PCS 1724*55*38mm	②  7PCS 1724*38*38mm	③  2PCS 2100*38*38mm	④  3PCS 2024*67*38mm	⑤  42PCS 2024*97*38mm
⑥  3PCS 2024*168*38mm	⑦  21PCS 1172*97*38mm	⑧  42PCS 150*97*38mm	⑨  21PCS 945*97*38mm	⑩  2PCS 1724*67*38mm
⑪  1PCS 1724*97*38mm	⑫  21PCS 1724*97*38mm	⑬  1PCS 1724*81*38mm	⑭  1PCS 1724*70*38mm	⑮  6PCS 2188*38*38mm
⑯  10PCS 2140*90*13mm	⑰  4PCS 330*33*33mm	⑱  2PCS 520*90*20mm	⑲  4PCS 340*90*20mm	⑳  1PCS 300*90*40mm
㉑  1PCS 252*90*40mm	㉒  4PCS 1927*90*66mm	㉓  2PCS 1927*90*66mm	㉔  2PCS 600*90*66mm	㉕  2PCS 600*90*66mm
㉖  2PCS 547*90*66mm	㉗  2PCS 1747*40*13mm	㉘  2PCS 700*38*17mm	㉙  2PCS 537*40*13mm	㉚  1PCS 627*38*17mm
㉛  1PCS 1765*545*47mm	㉜  1PCS 2022*560*33mm	㉝  1PCS 1162*560*33mm	㉞  1PCS 2022*300*33mm	㉟  72PCS 1130*97*18mm
㊱  34PCS 2022*97*18mm	㊲  4PCS 1132*90*20mm	㊳  2PCS 1552*90*20mm	㊴  3PCS 1684*90*38mm	㊵  3PCS 1022*90*38mm

 10PCS 80*60*38mm	 12PCS 90*90*20mm	 1PCS 1550*33*13mm	 1PCS 1100*81*38mm	 1PCS 1100*70*38mm
 1PCS 1060*400*33mm	 3PCS 2022*90*38mm	 1PCS 1946*38*38mm	 1PCS 1162*90*38mm	 1PCS 1124*38*38mm
 3PCS 522*38*38mm	 2PCS 300*38*38mm	 2PCS 362*38*38mm	 2PCS 1100*67*38mm	 1PCS 820*40*20mm
 22PCS 1100*97*38mm	 1PCS 1060*90*38mm	 1PCS 1022*38*38mm	 42PCS 198*97*38mm	 2PCS 1100*55*38mm
 7PCS 1100*38*38mm	 9PCS 200*38*38mm	 1PCS 1764*544*6mm	 1PCS 1733*594*6mm	 1PCS 300*142*105MM
 Sauna light	 Sauna stove	 69PCS 1000*320*5mm		

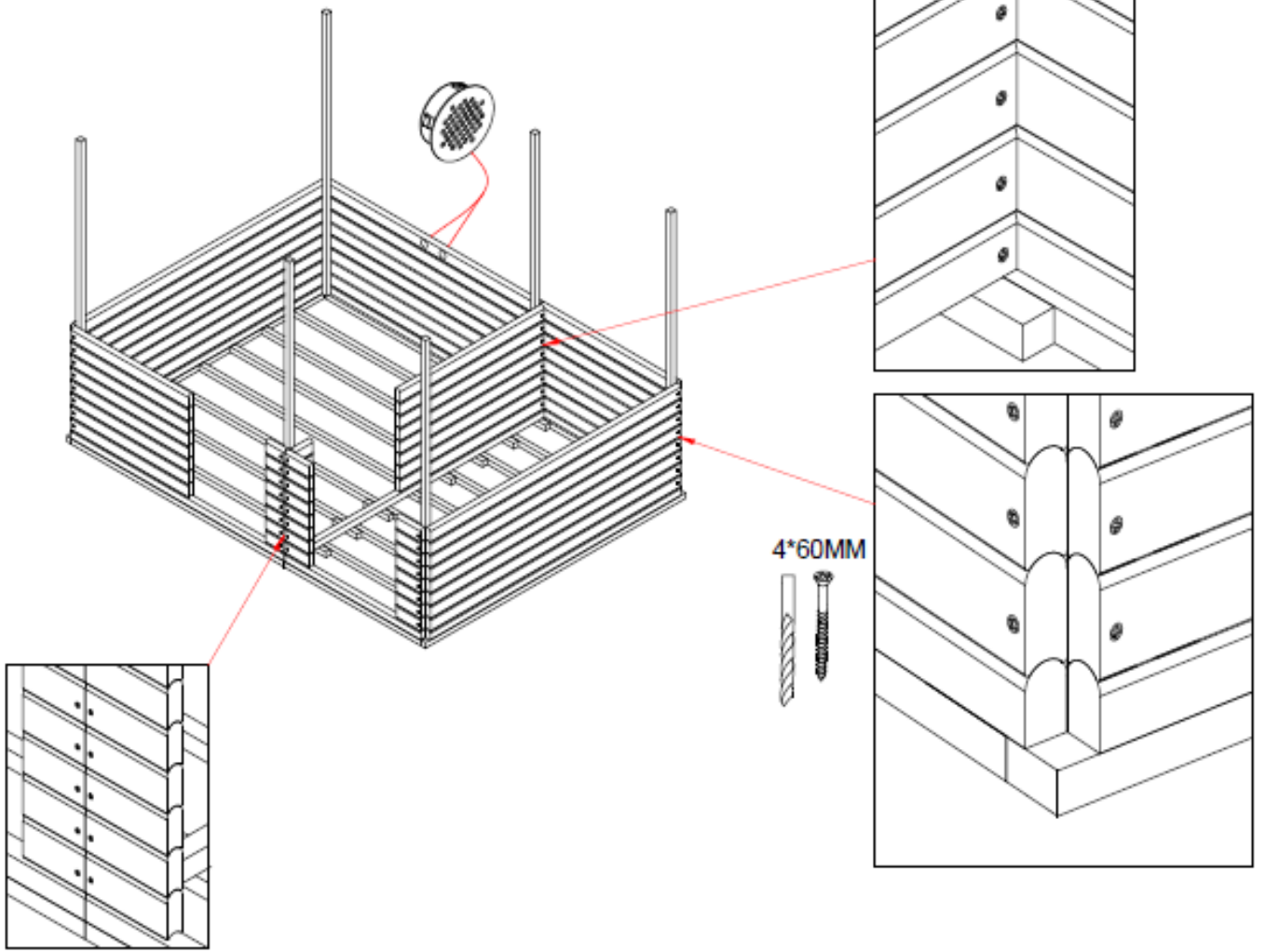
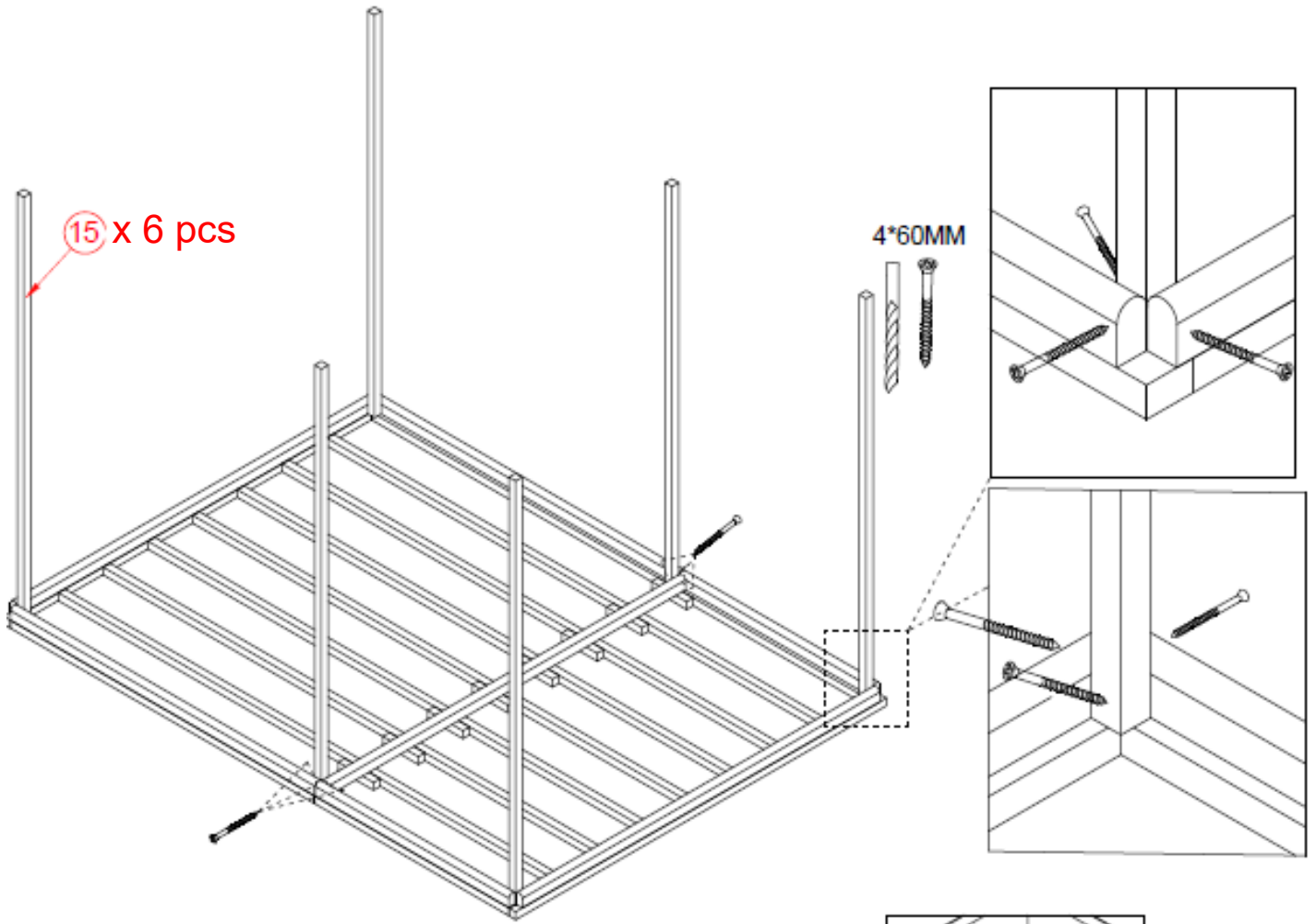

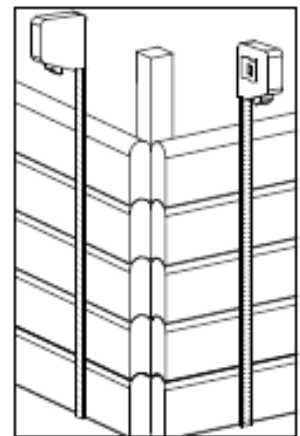
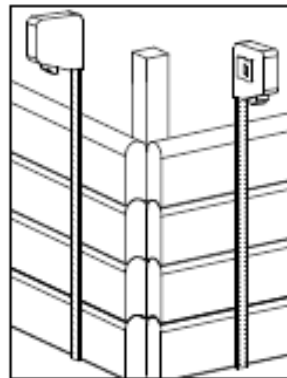
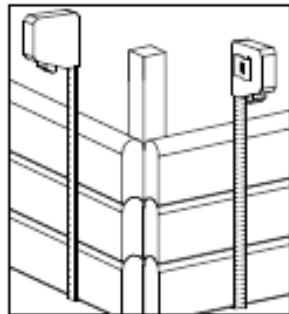
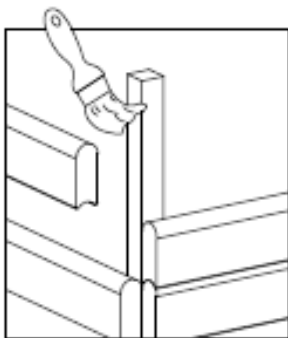
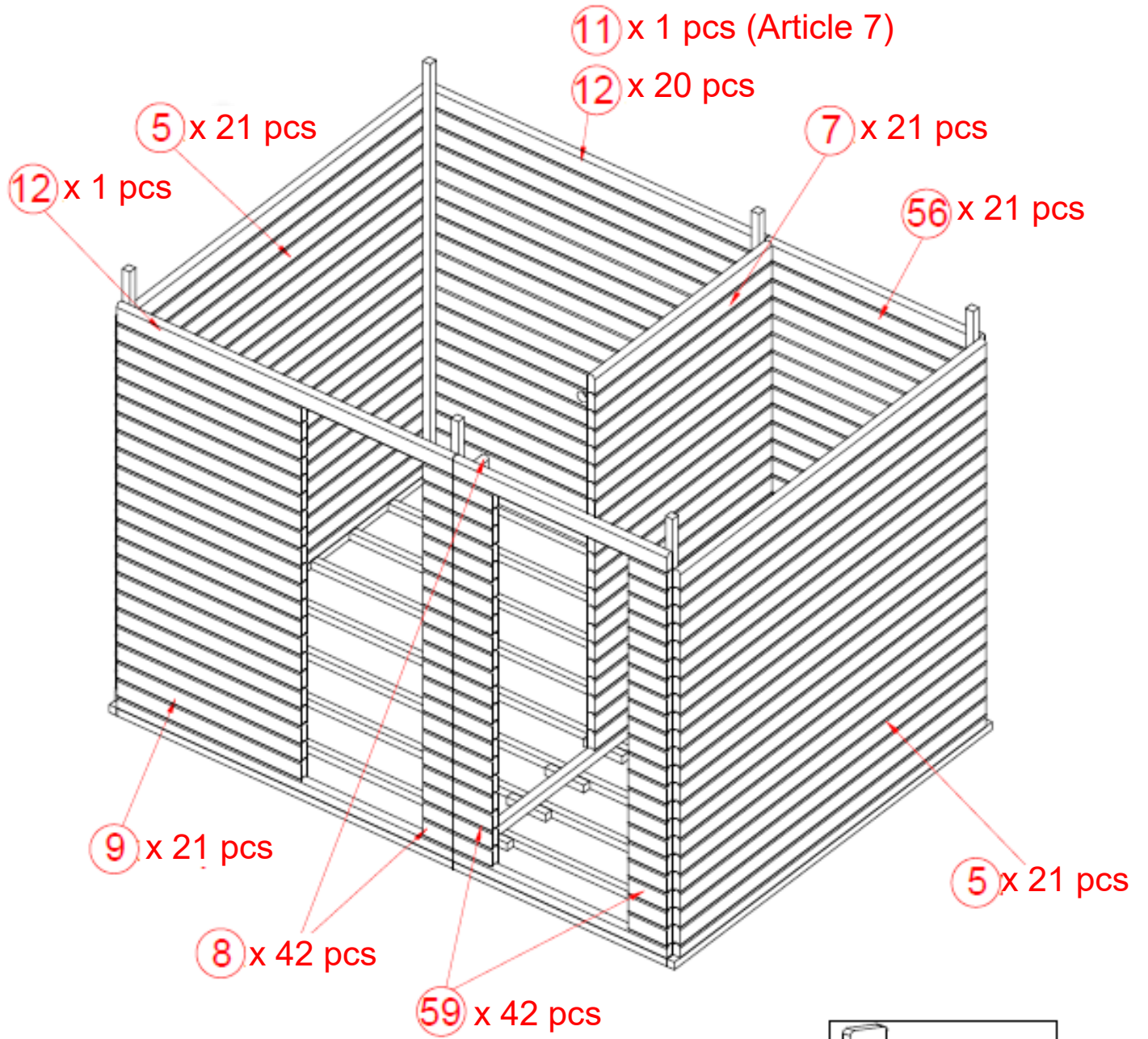

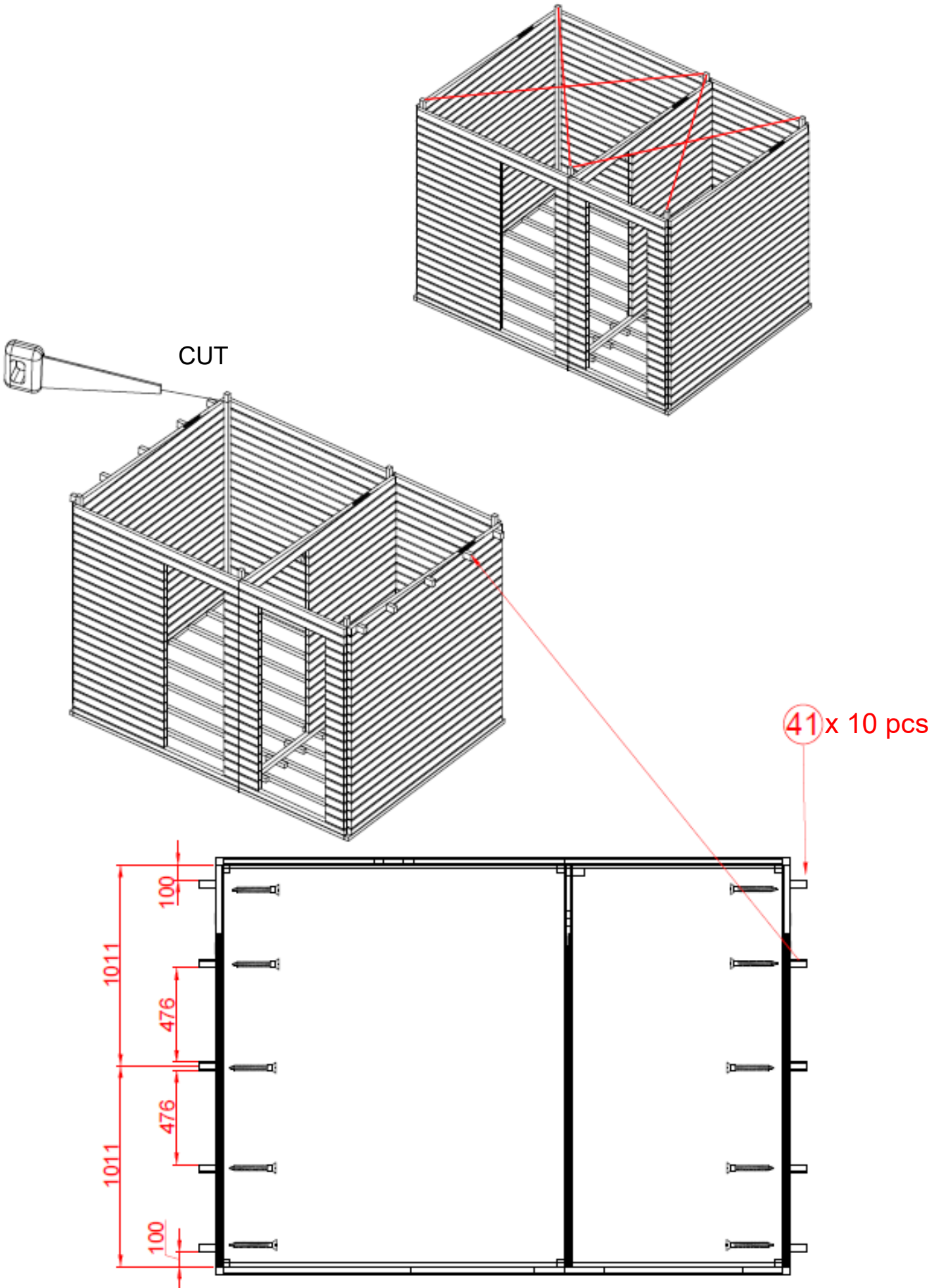

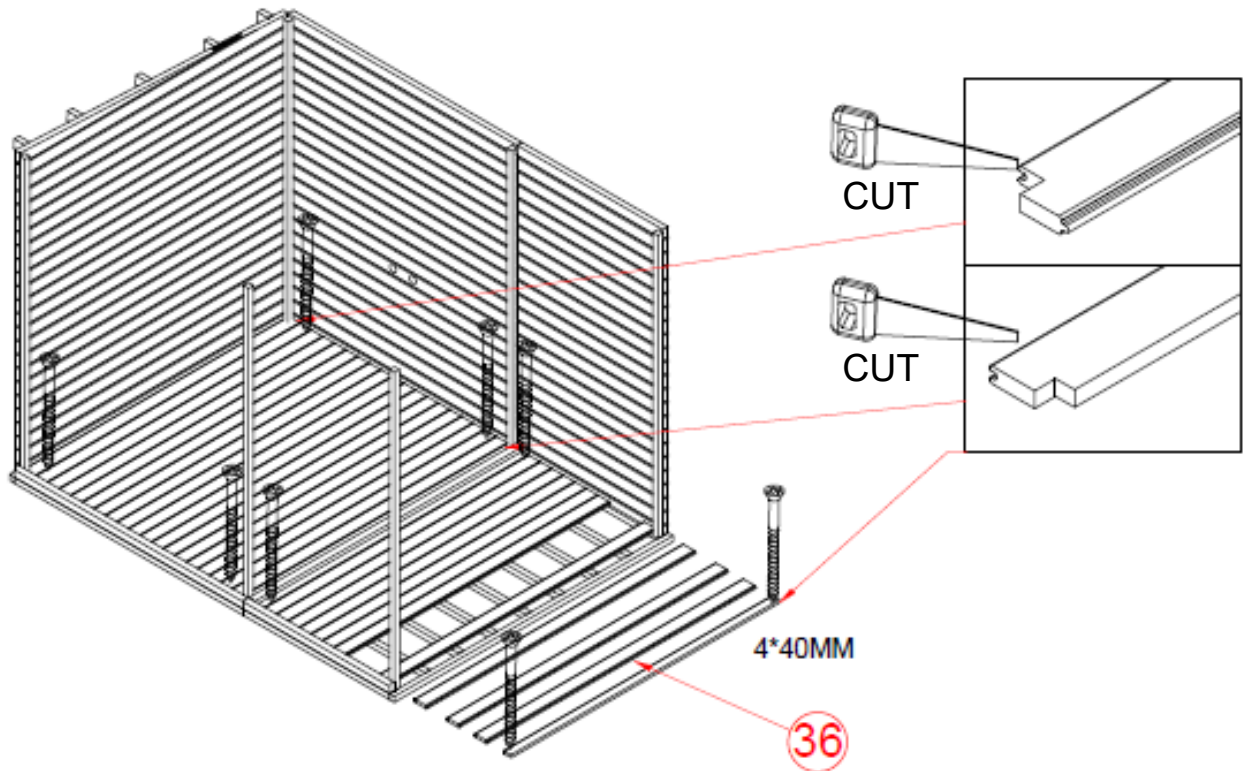
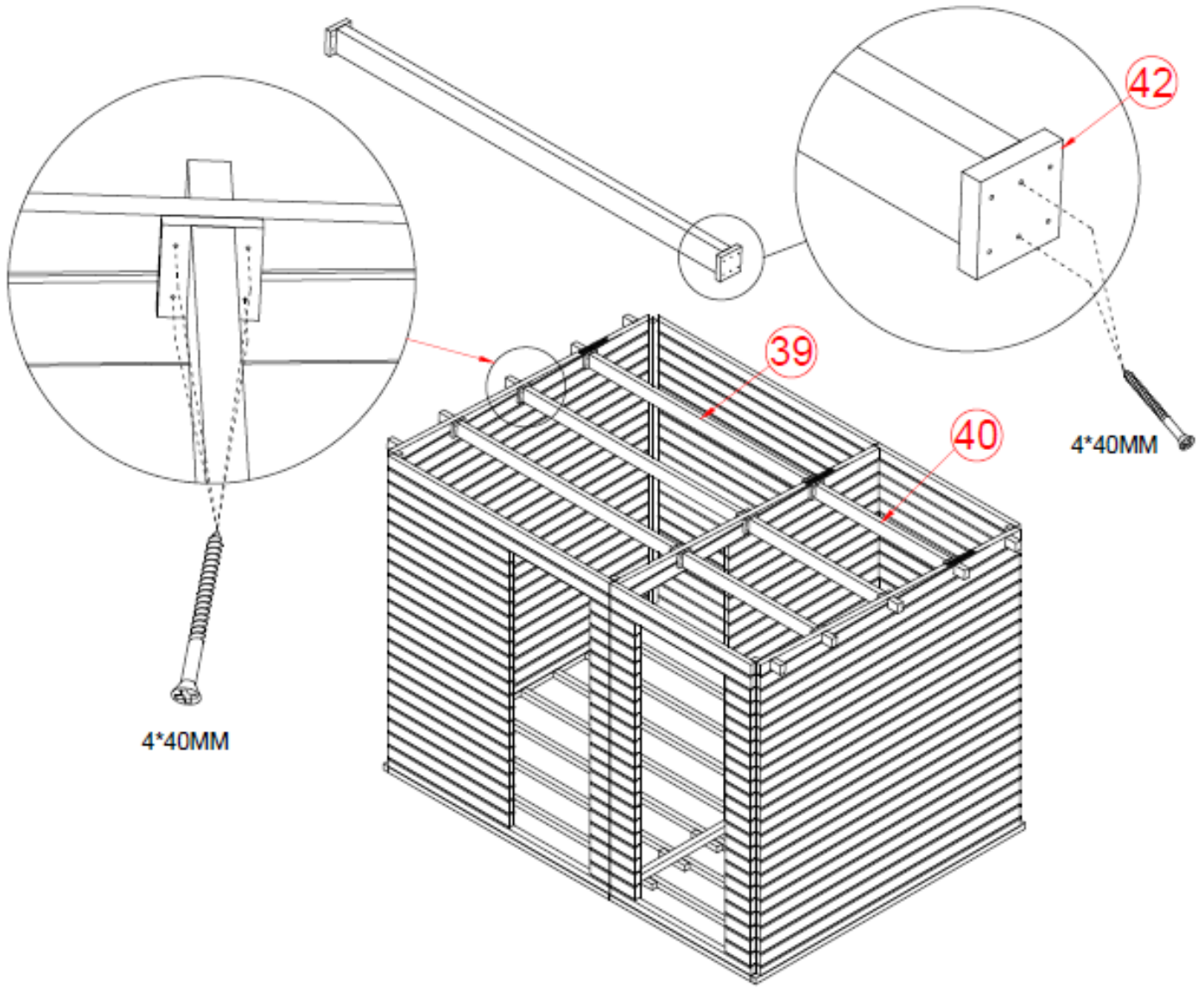

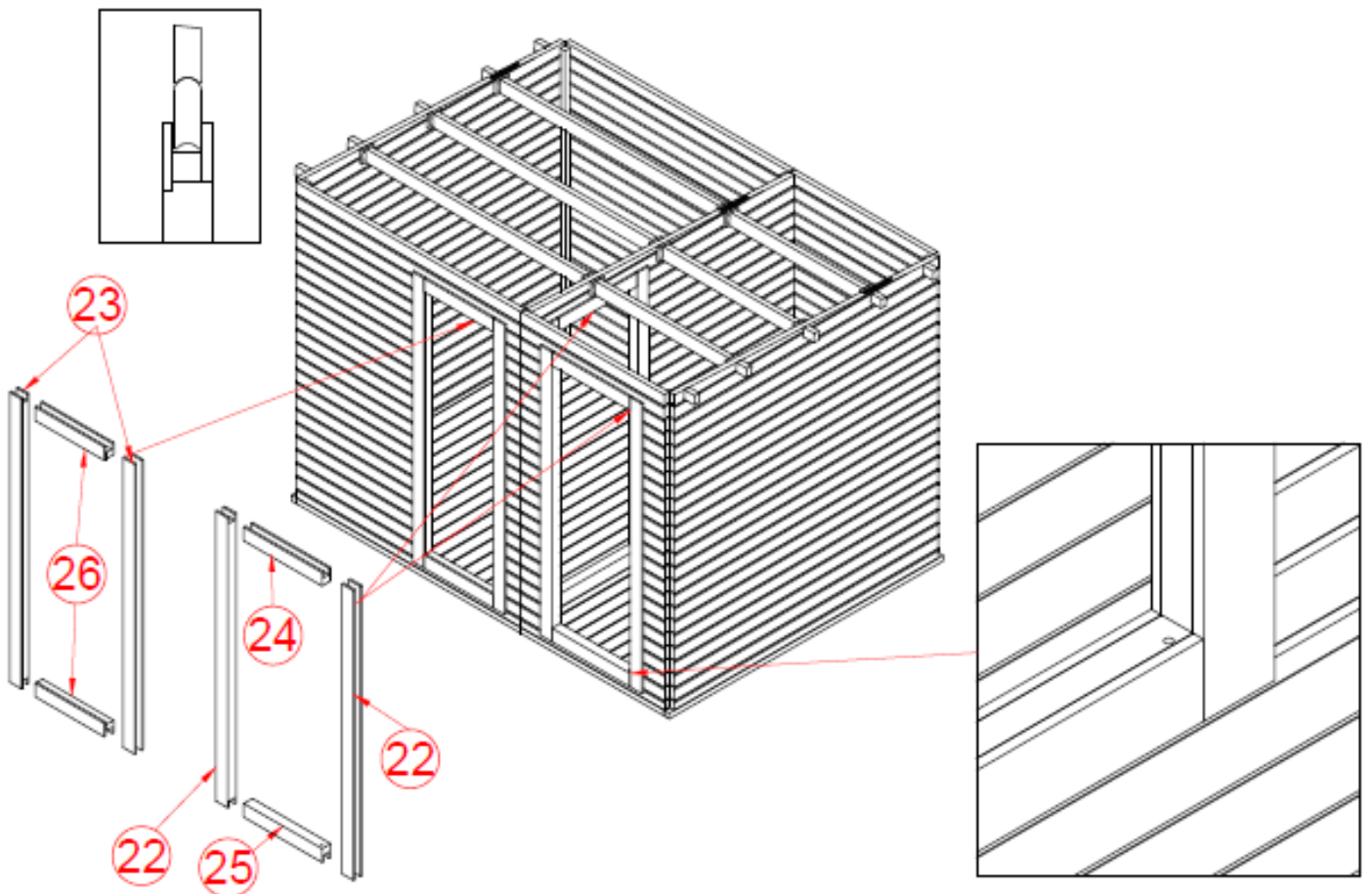
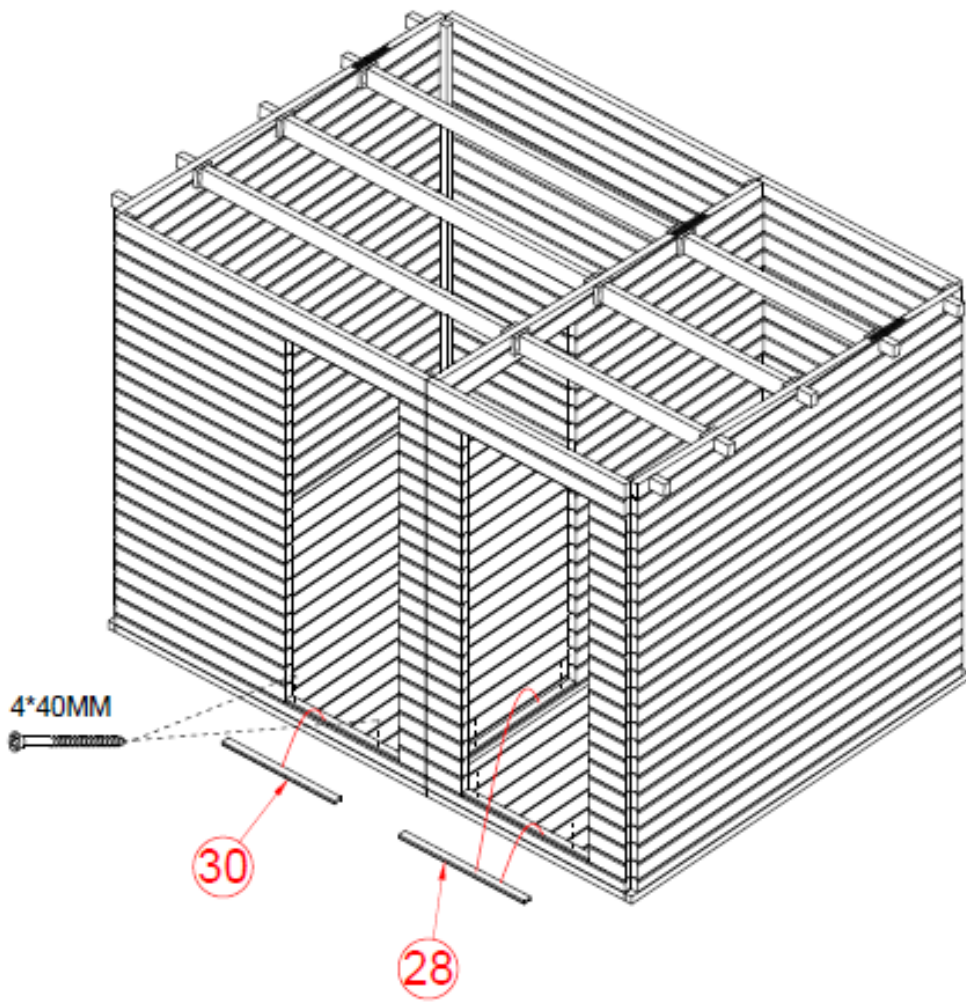

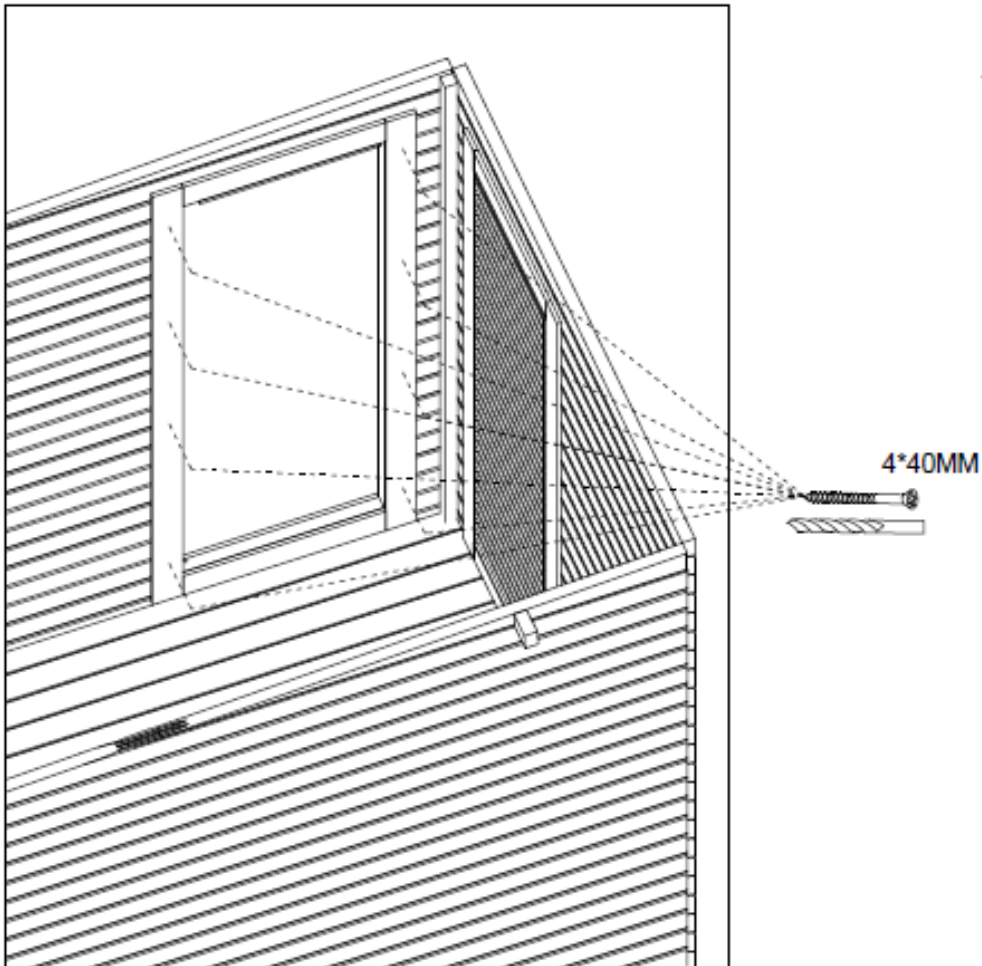
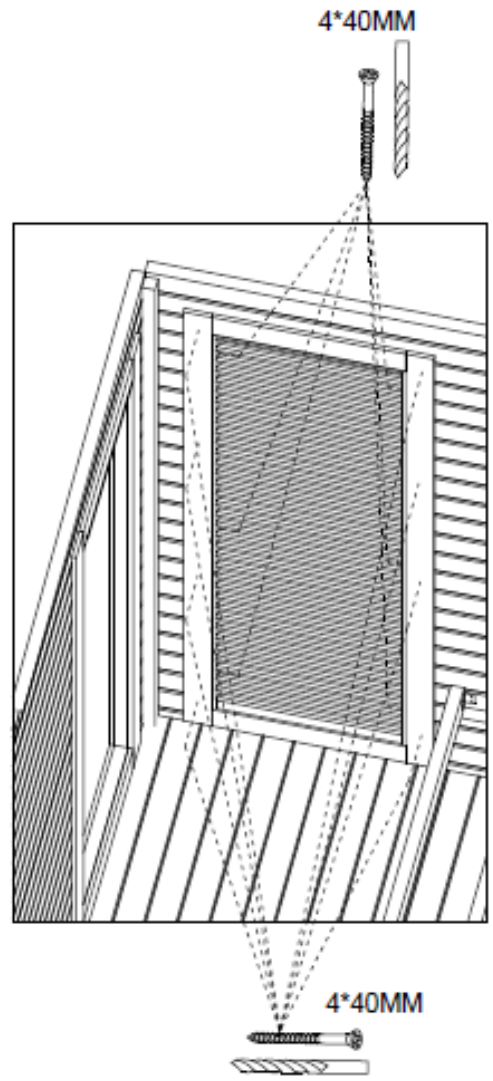
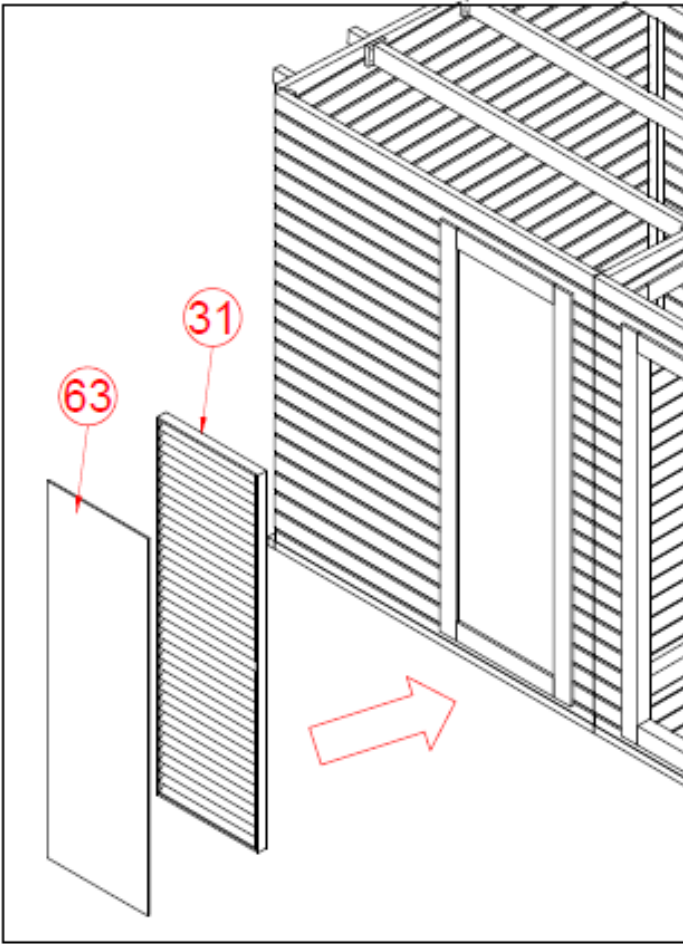

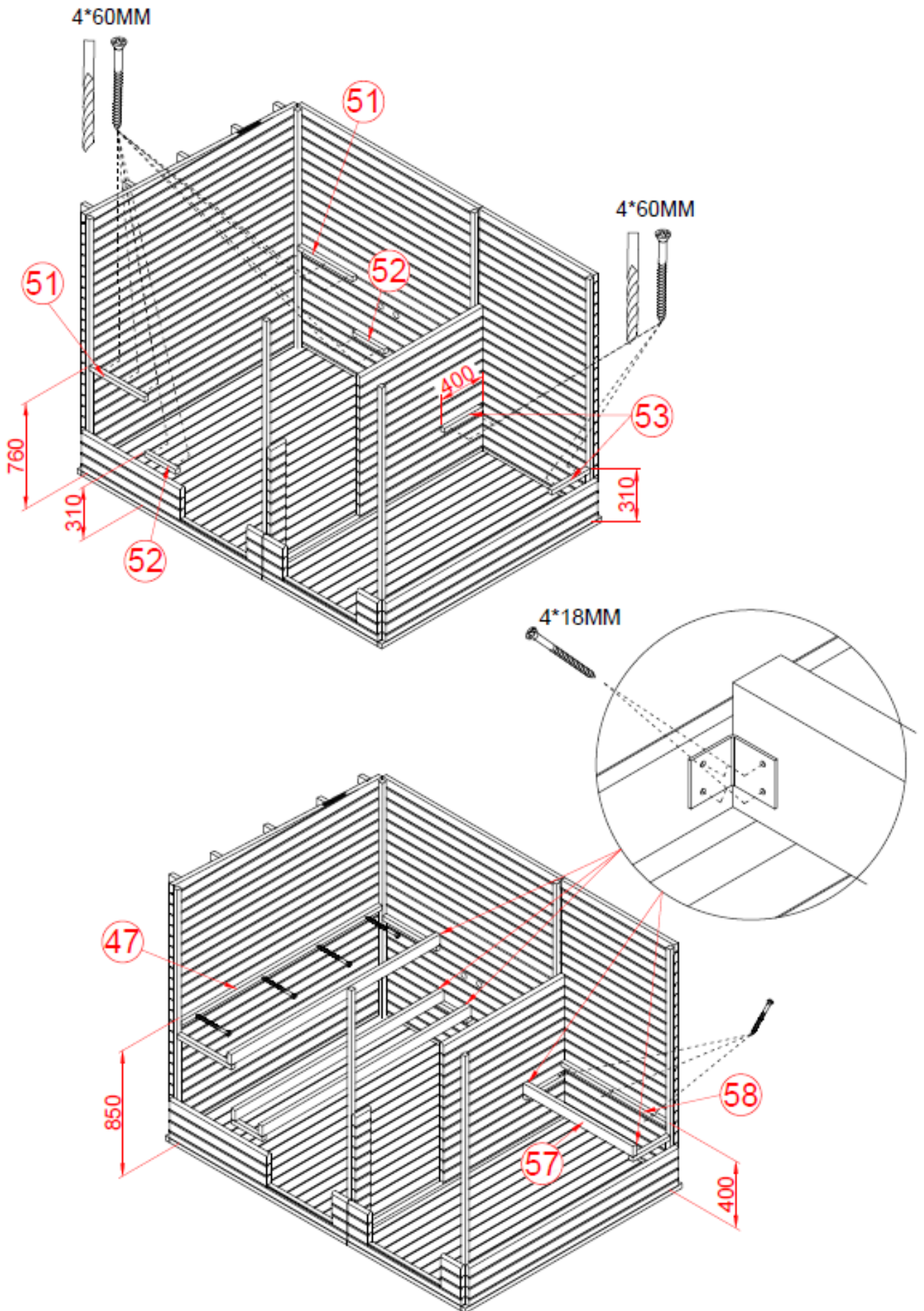

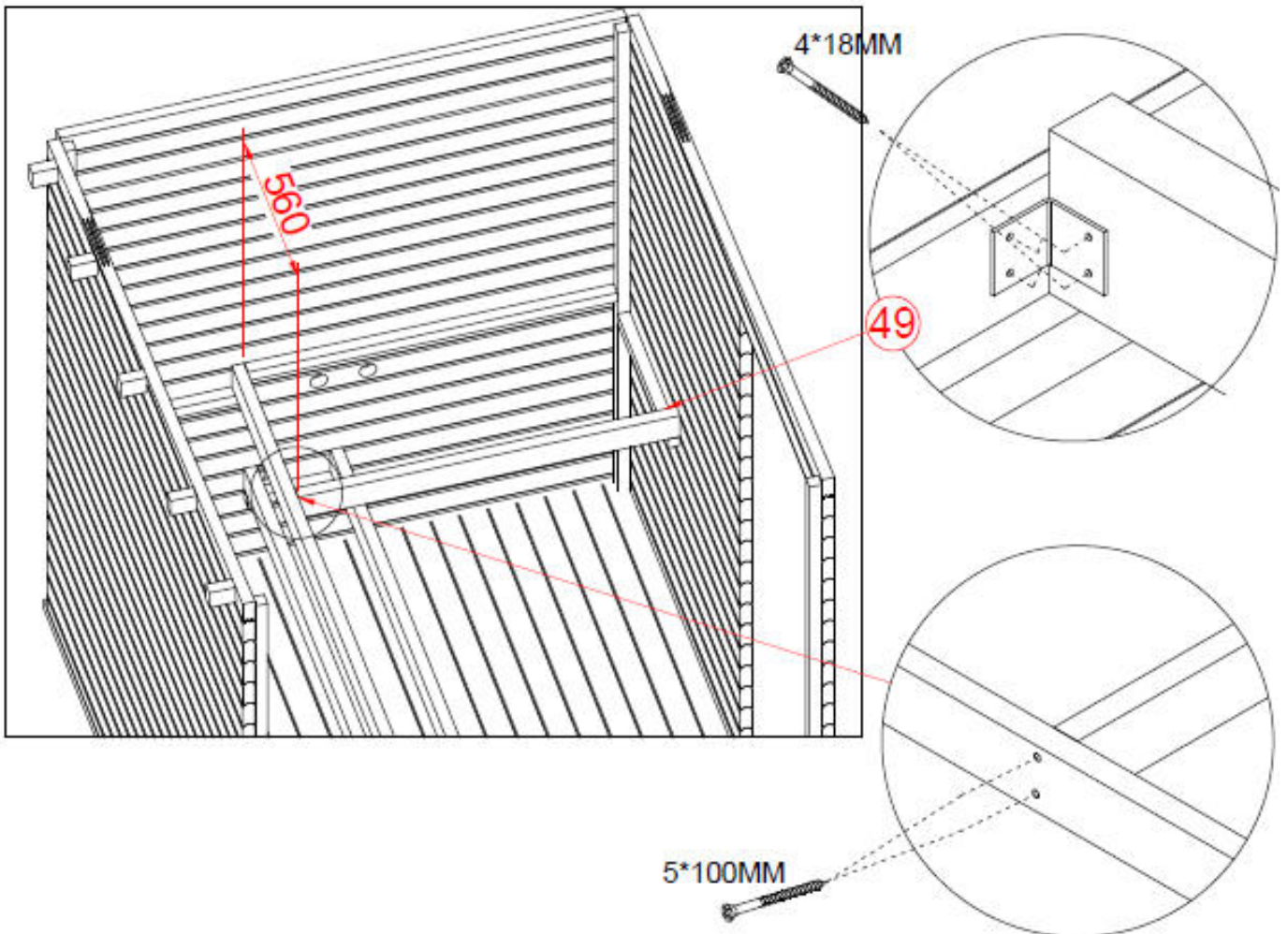
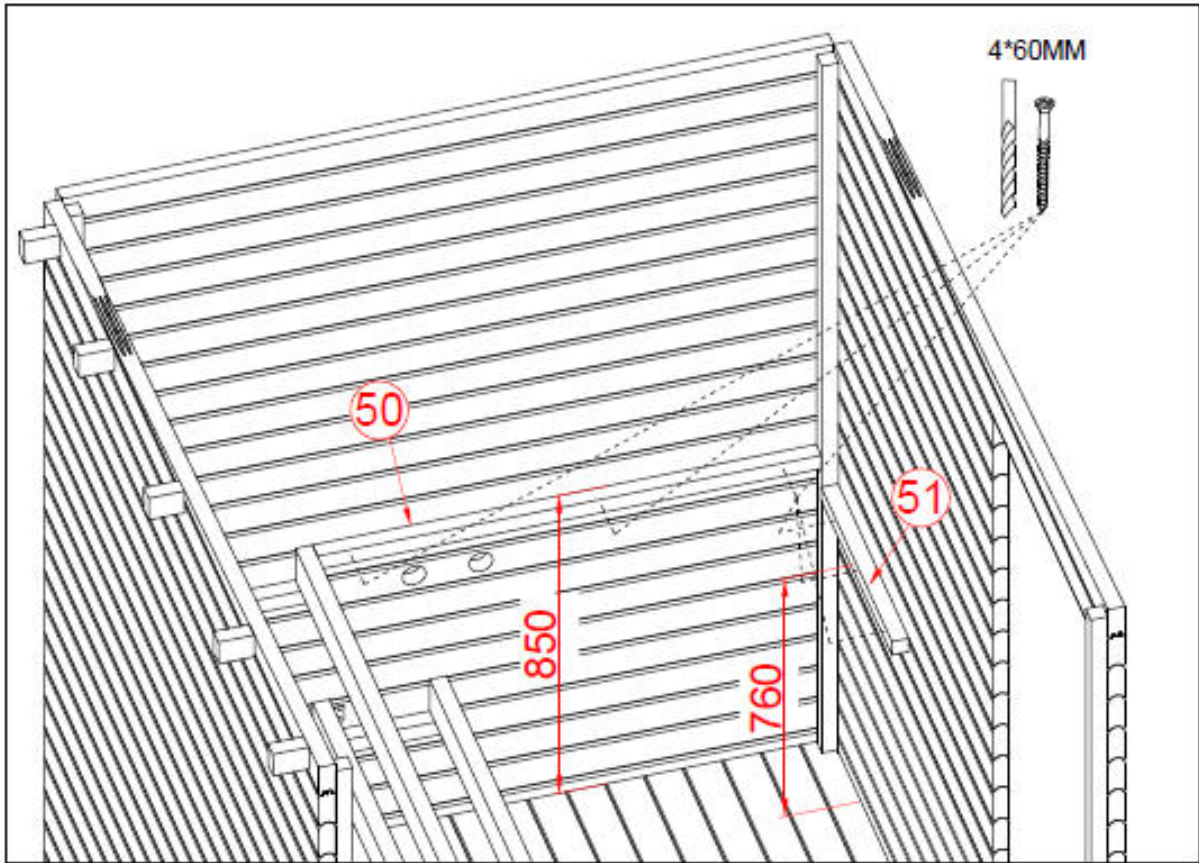

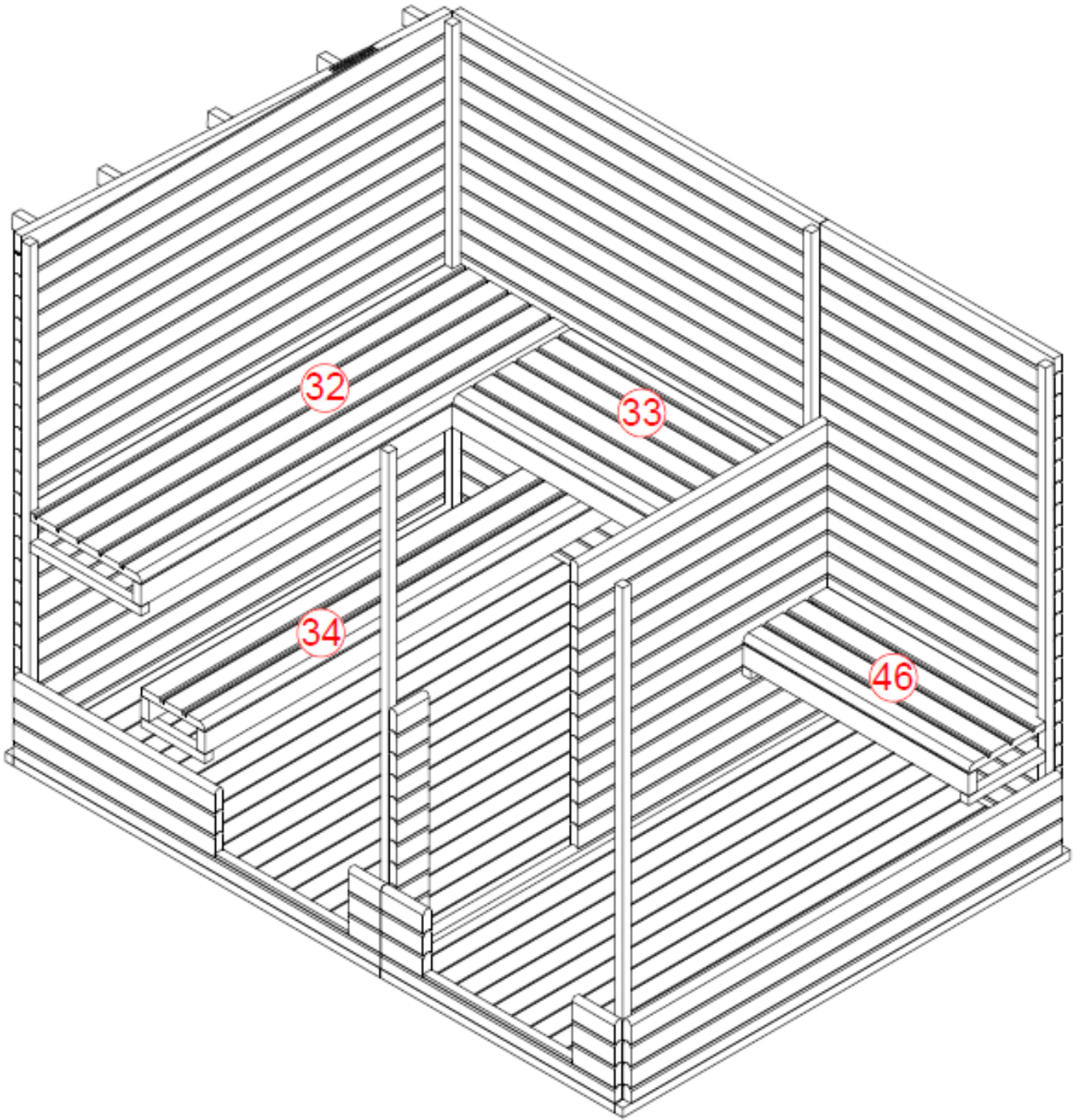

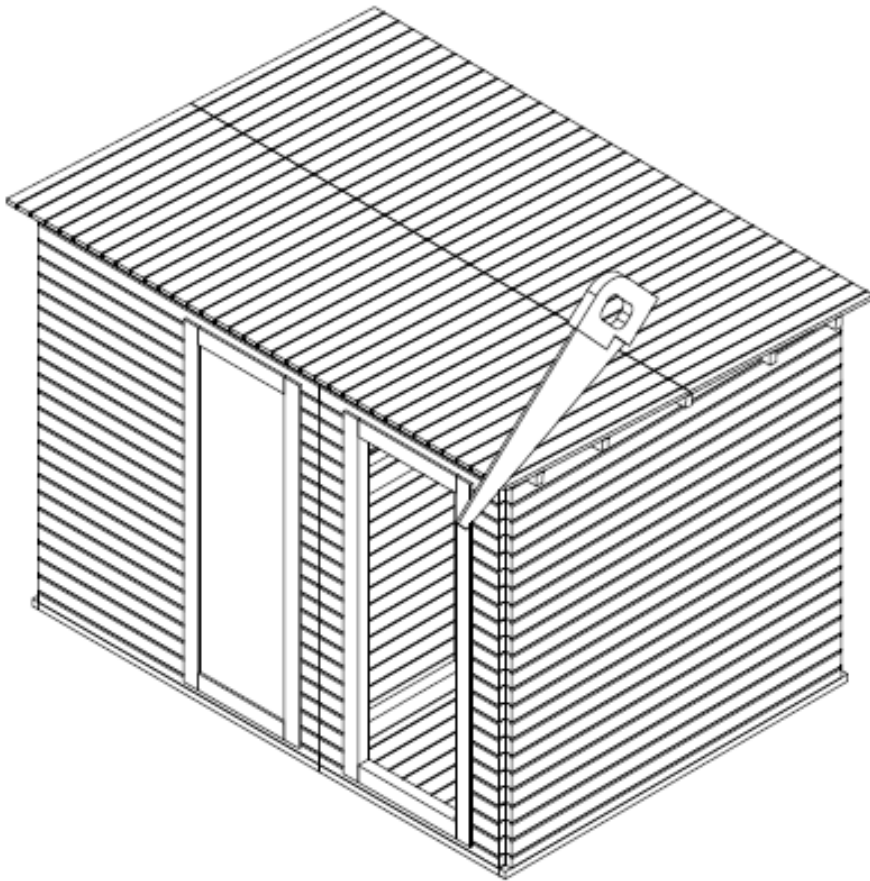
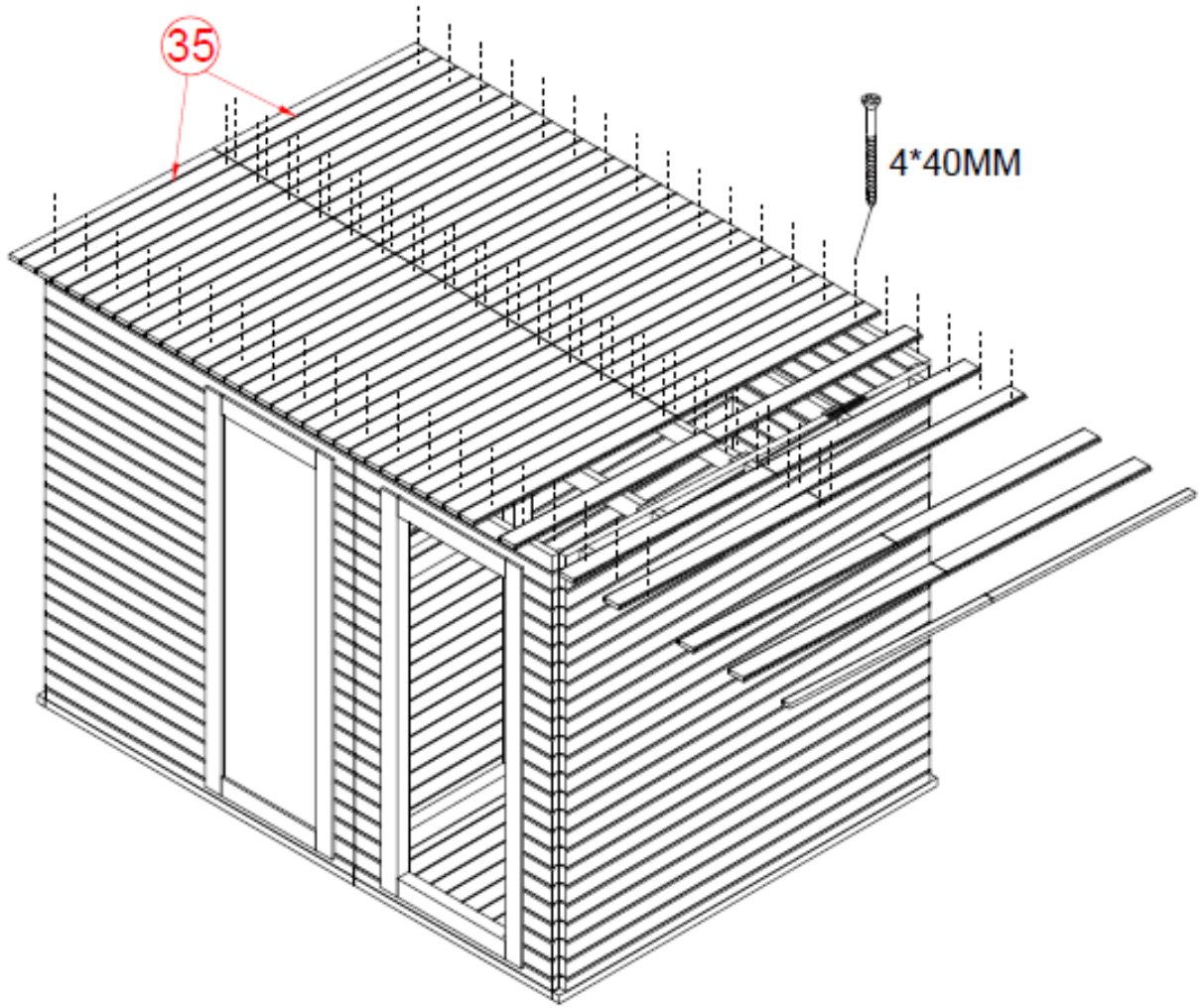

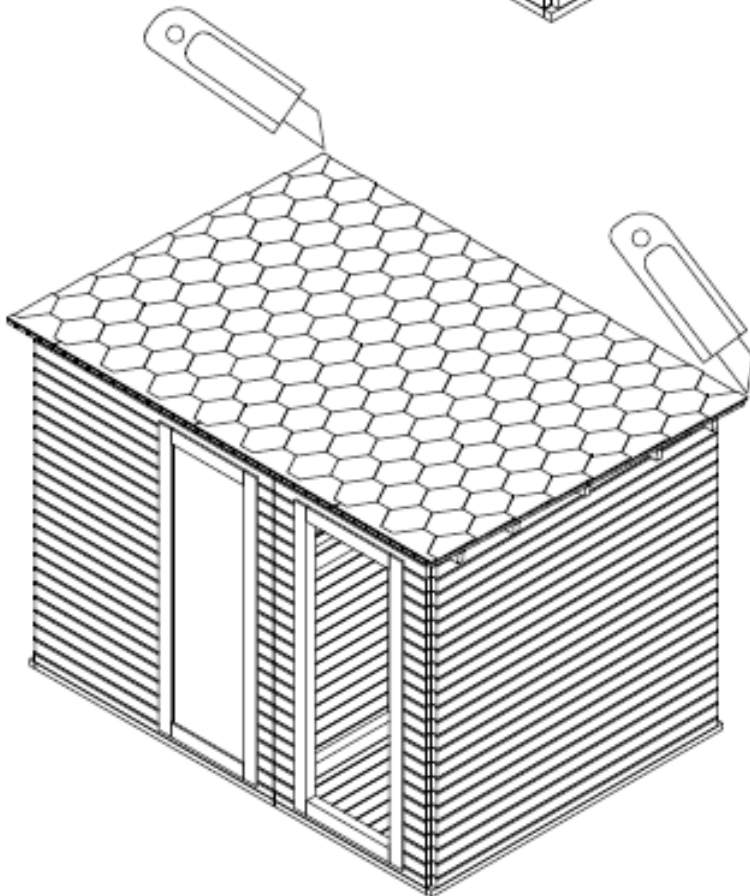
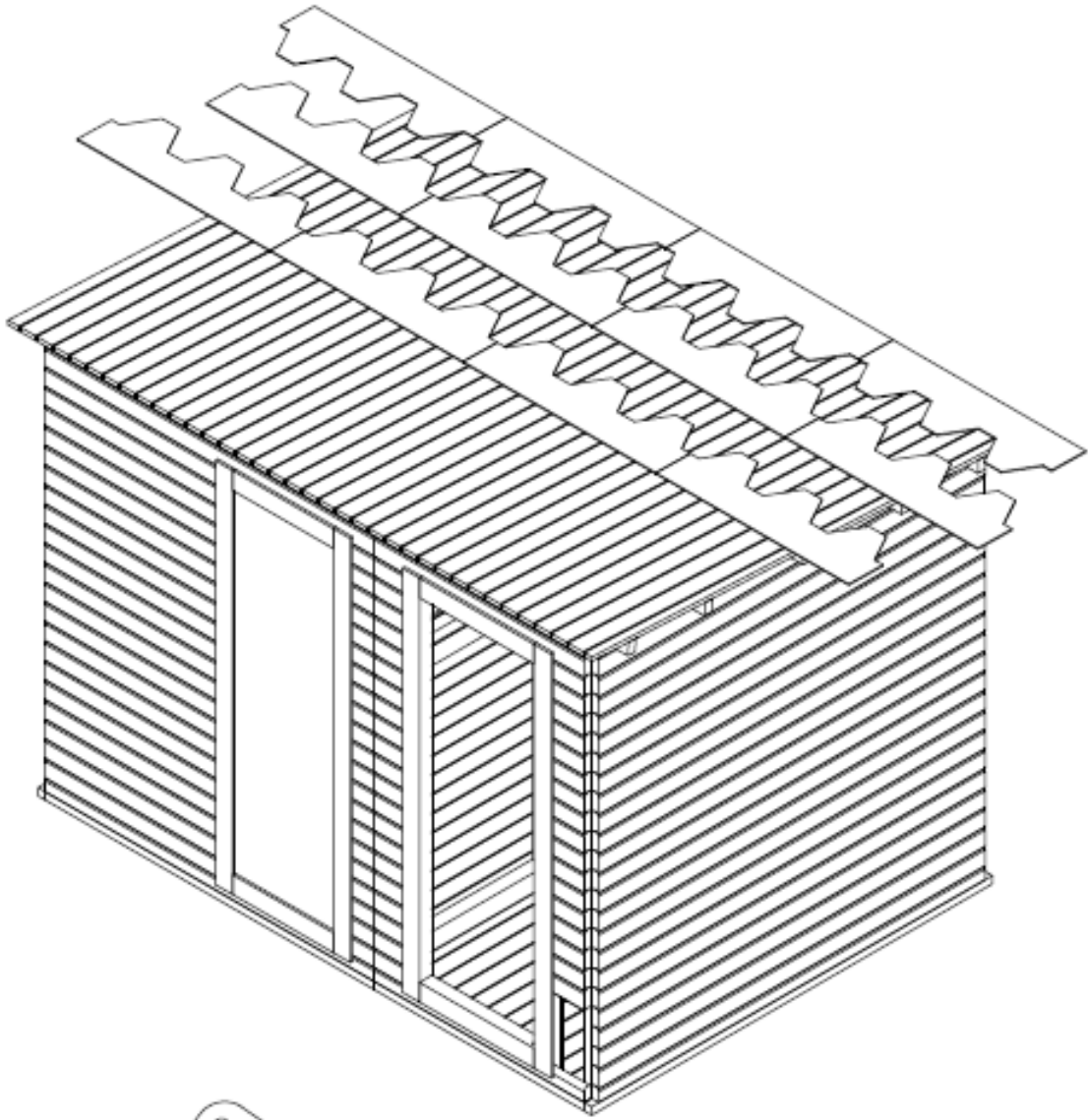

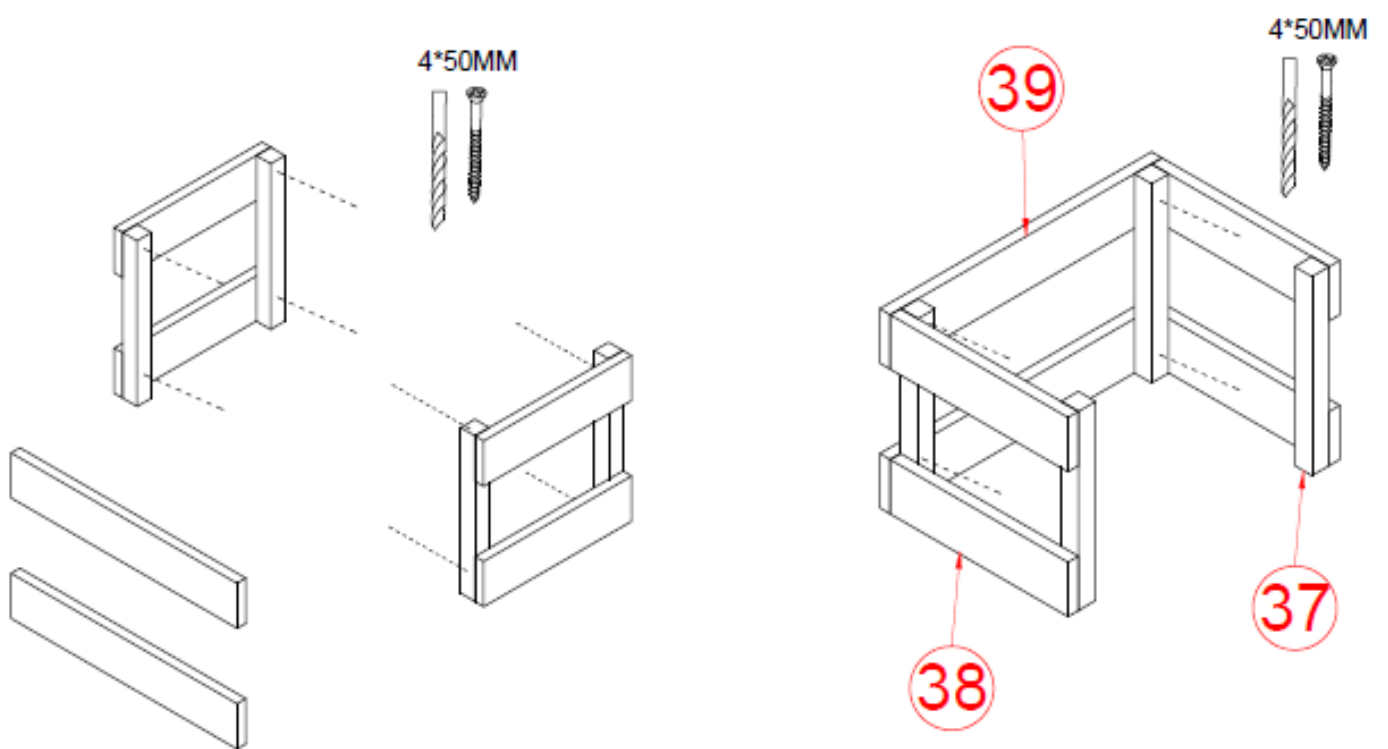
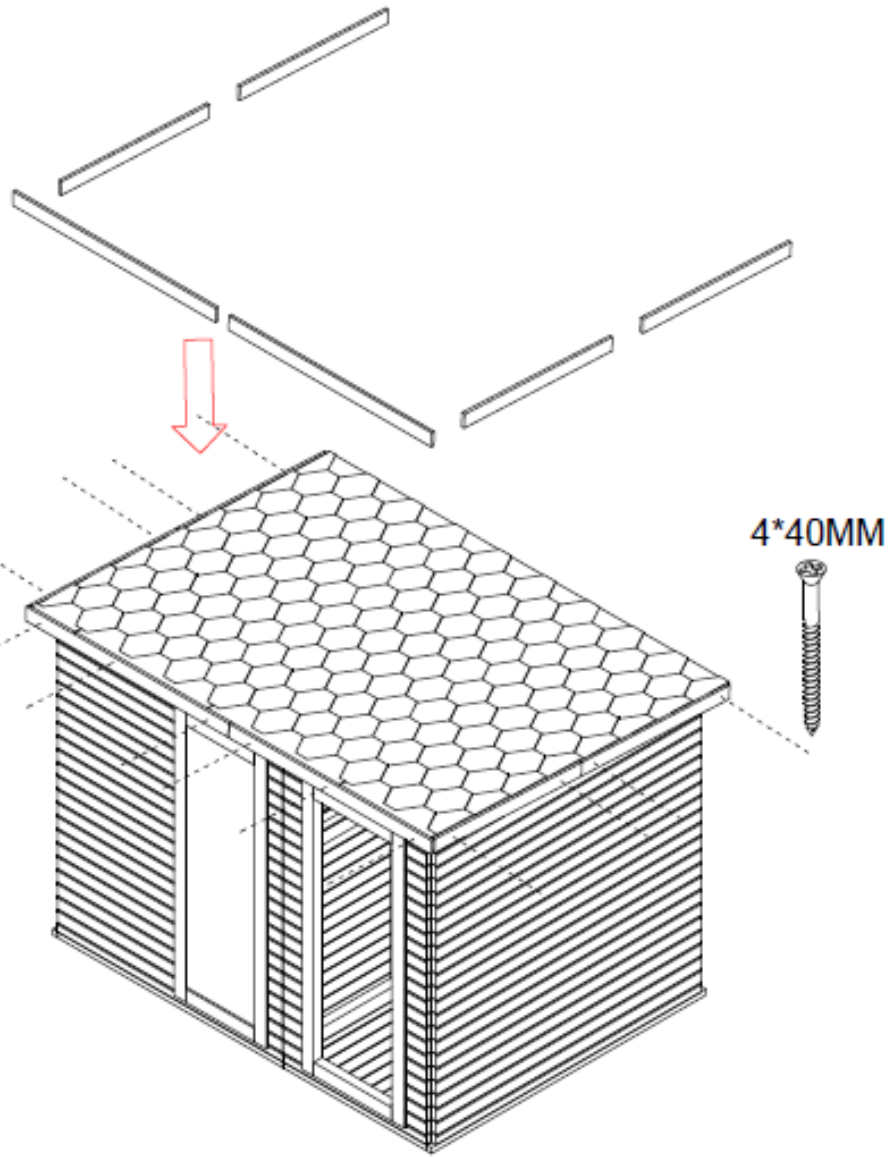

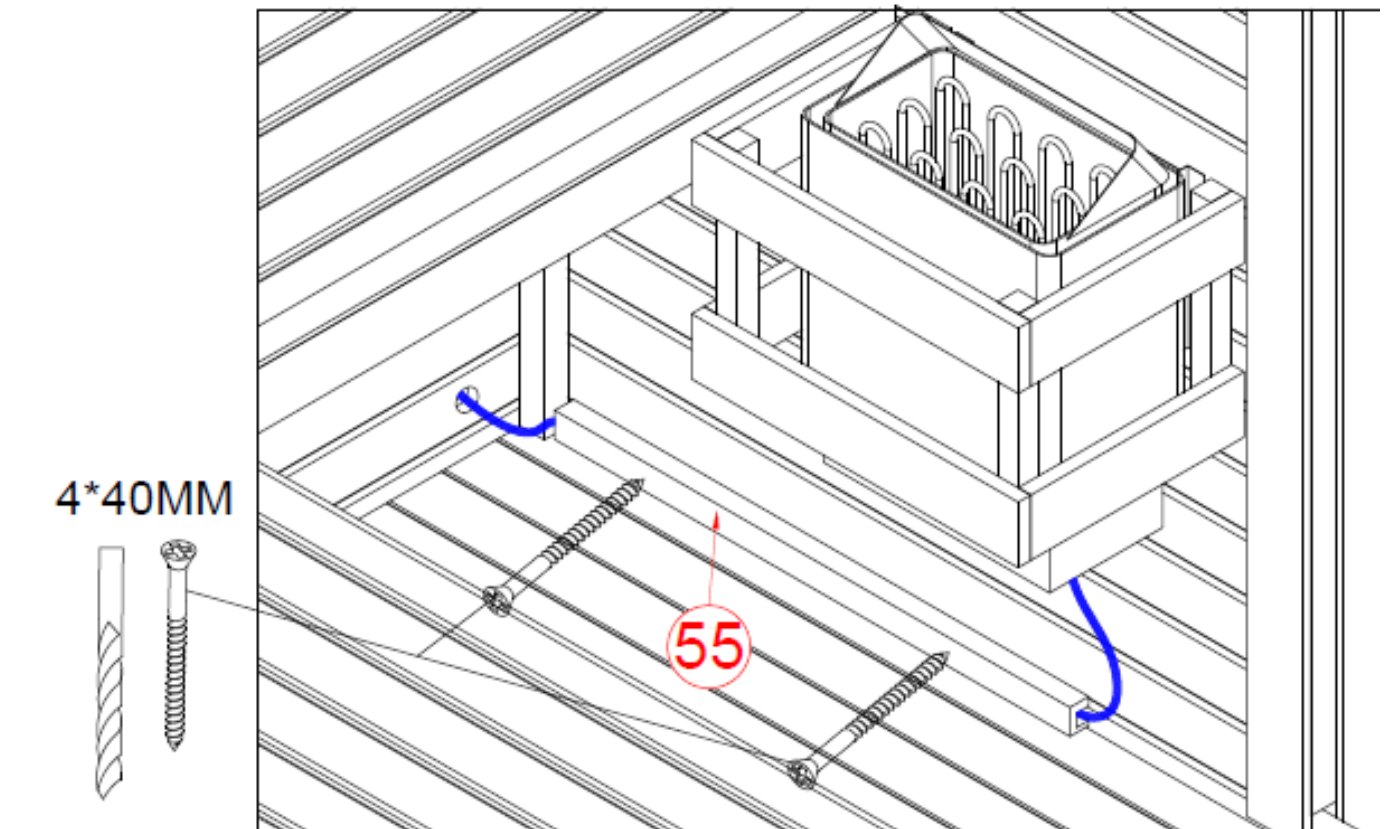
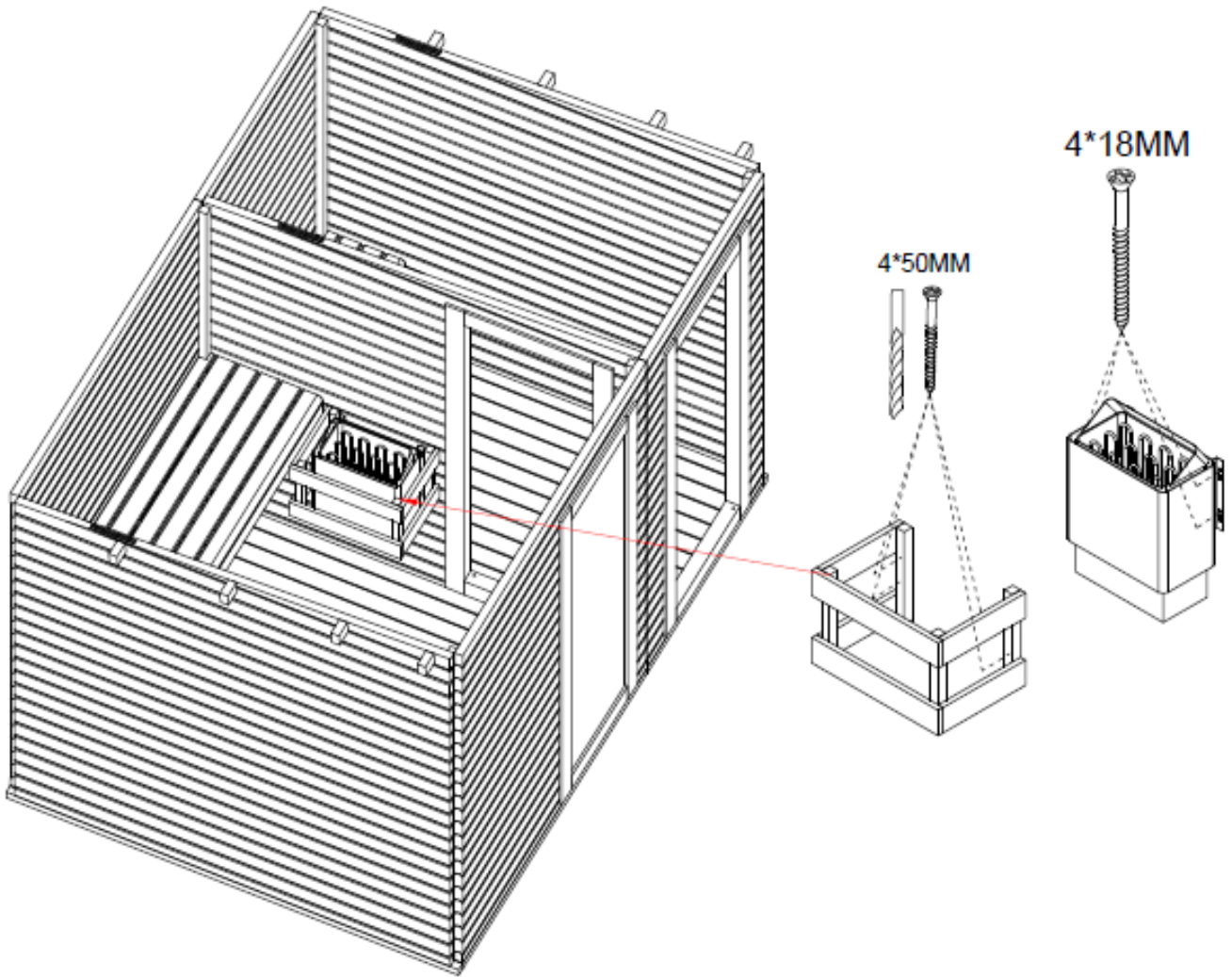

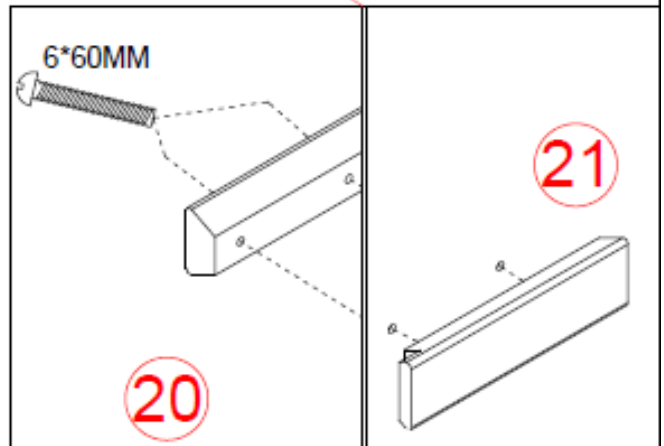
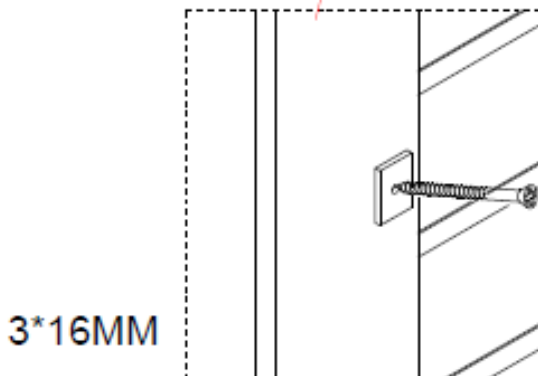
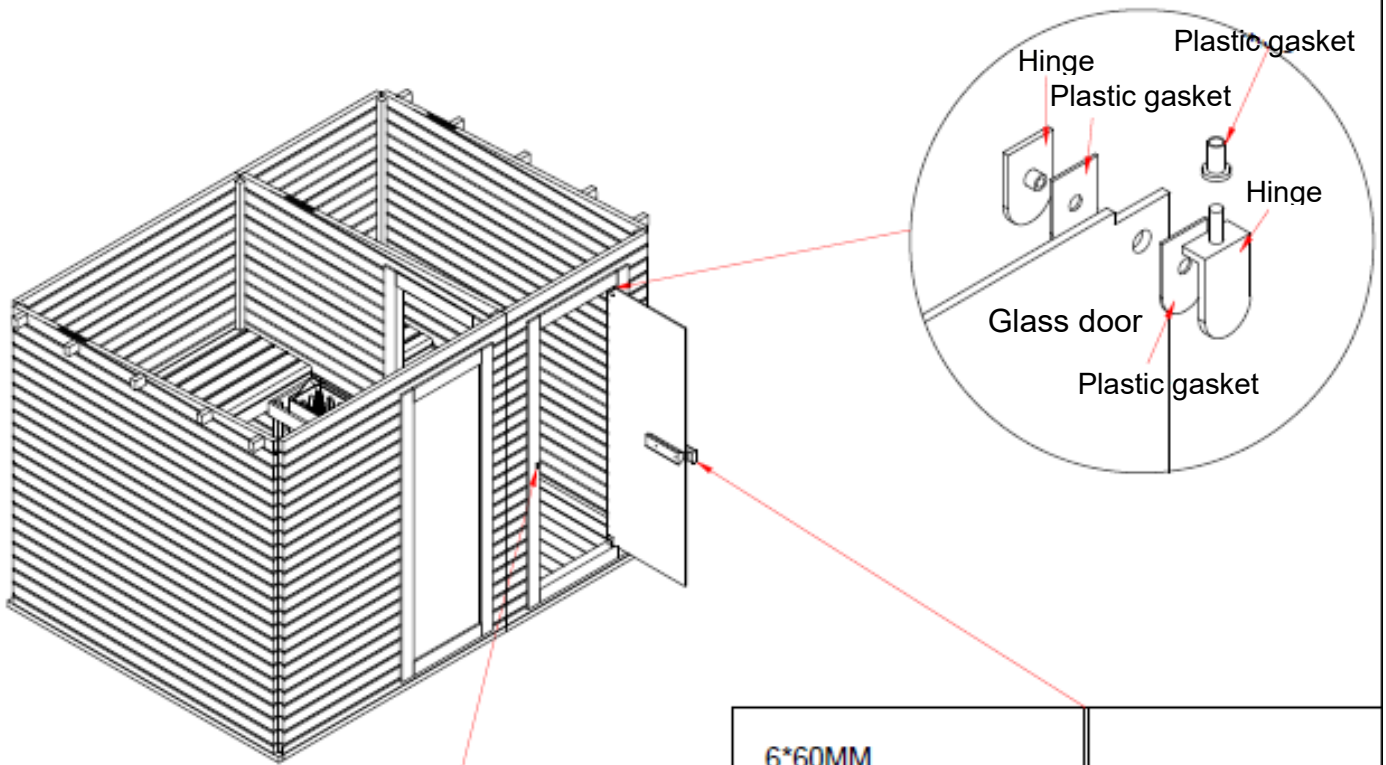
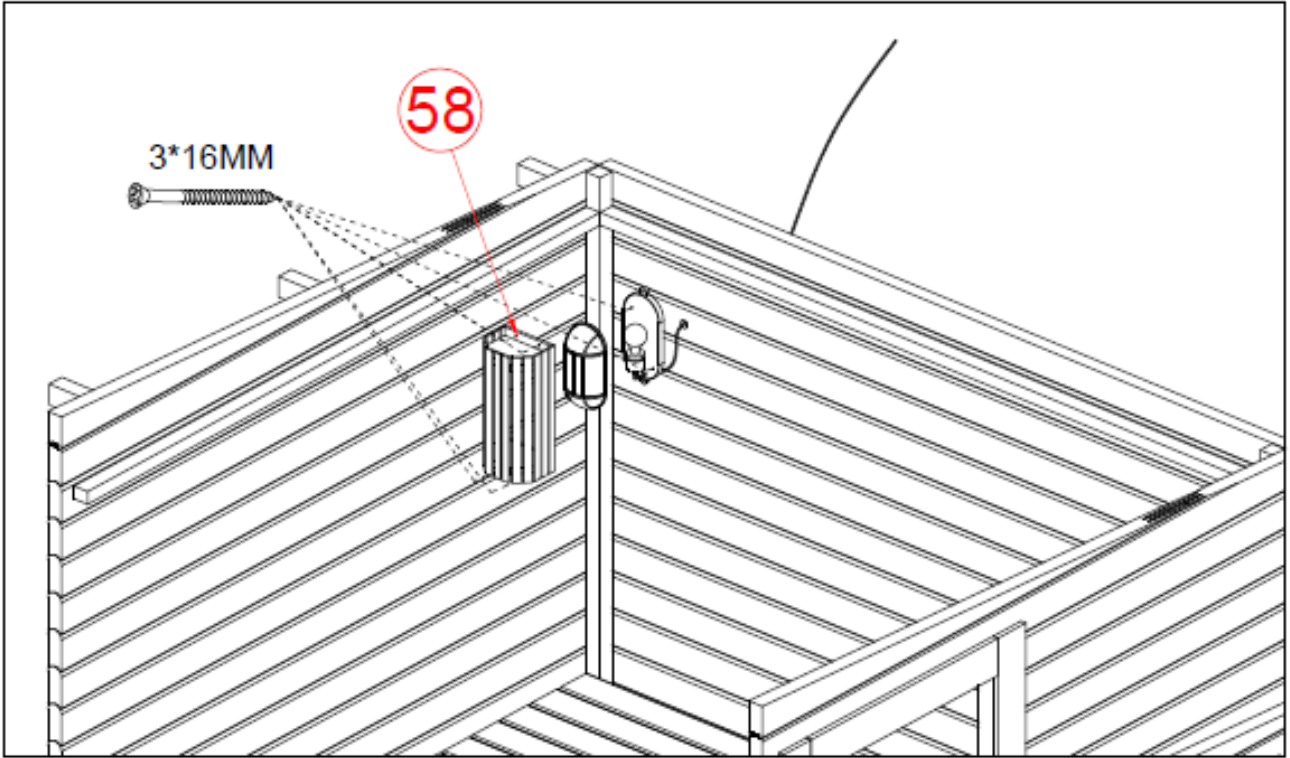

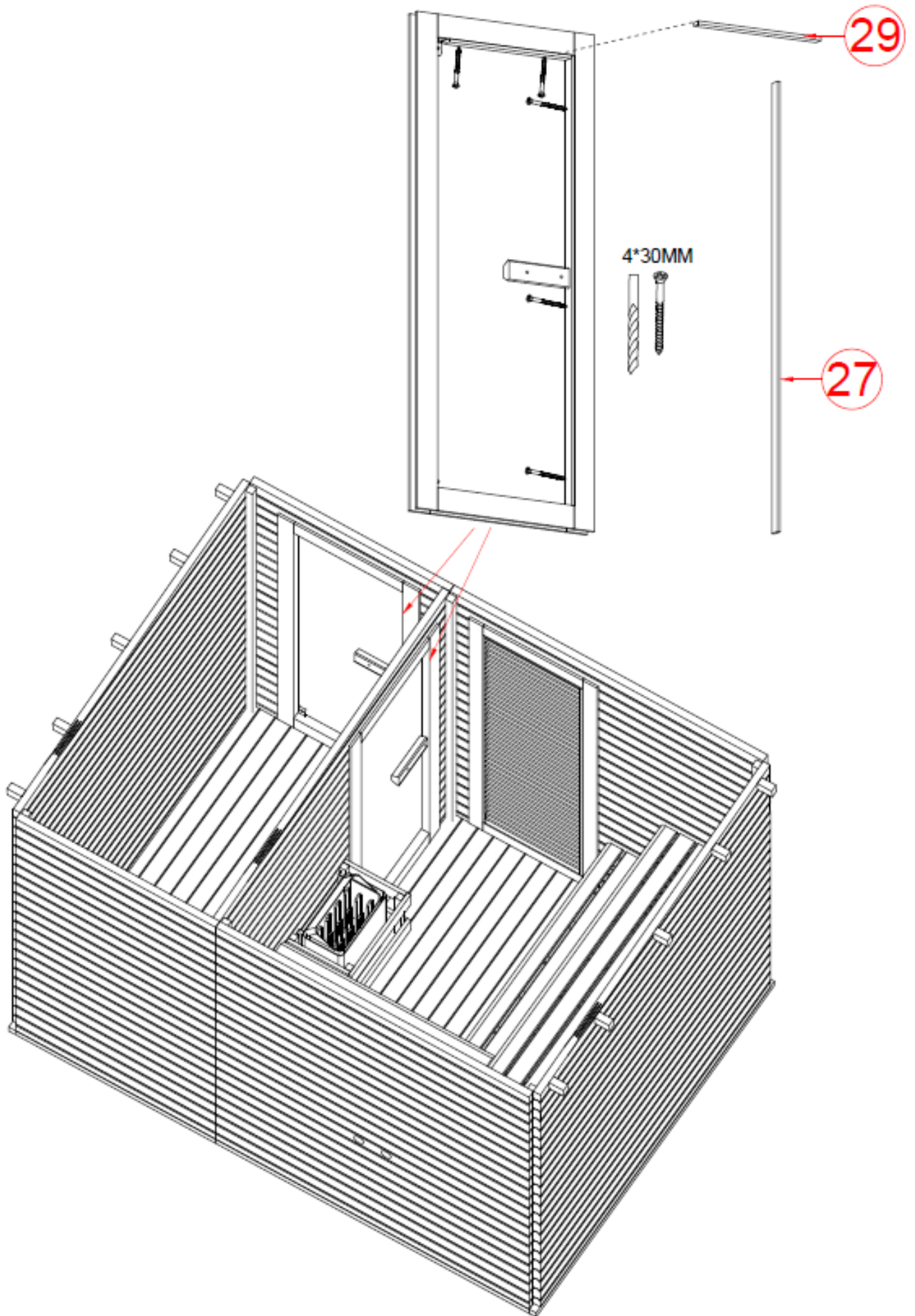

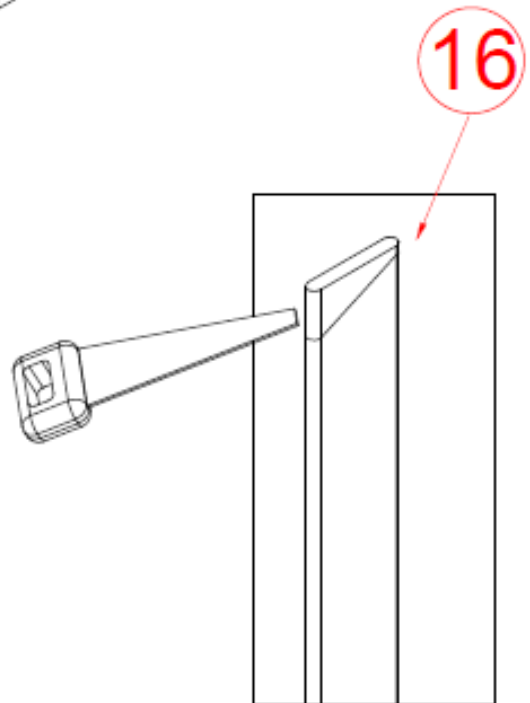
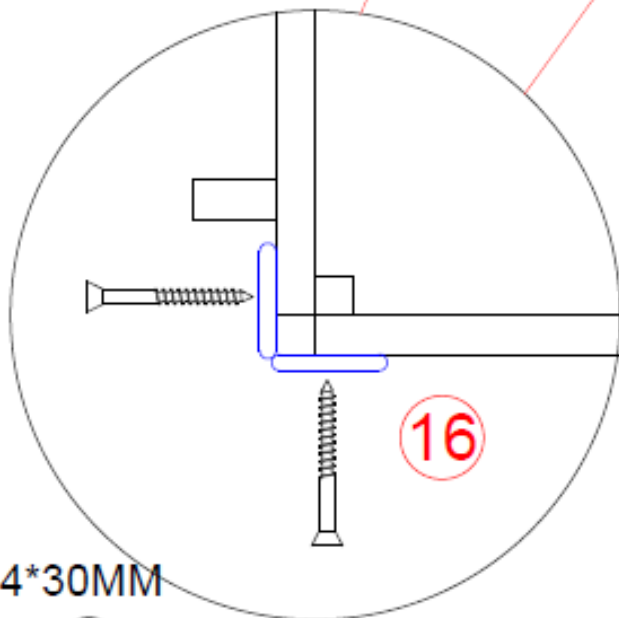
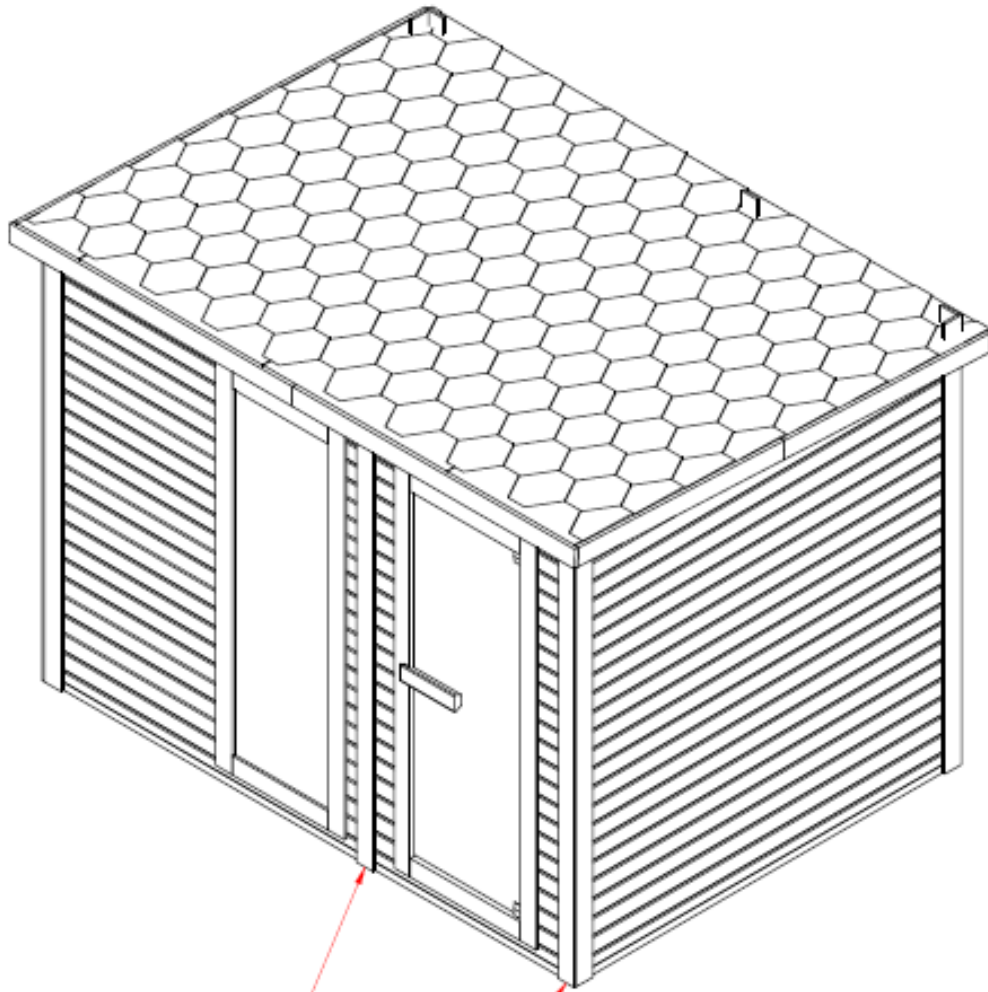

4*30MM

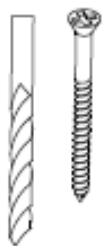

Инструкции за поддръжка

Защита на дърво

Външната страна на стената на сауната трябва да бъде лакирана след монтажа.

Този процес предпазва дървото от атмосферните влияния и удължава използваемостта и издръжливостта на дървото и го прави устойчиво на вода и насекоми!

Защитният агент трябва да се подновява според препоръките на използвания продукт

Почистване:

1. изключете сауната си
2. използвайте прахосмукачка, за да отстраните праха от пукнатините в дървената ламперия
3. почистете кабината с влажна памучна кърпа и използвайте малко количество сапун, ако е необходимо. Изплакнете с влажна кърпа.
- 4 Почистете стъклото с препарат за почистване на прозорци/стъкла и мека кърпа.
5. поддържайте външността на сауната на всеки 2 години с подходящ продукт.

ВАЖНО!

Дървесината трябва да се третира със защитен продукт само от външната страна на сауната.

Вътре в сауната не могат да се извършват процедури.

Не използвайте бензол, алкохол, химически агенти или силни почистващи препарати за сауната, тъй като химическите продукти могат да повредят дървото. Не пръскайте сауната си с вода.

Моля, прочетете инструкциите, предоставени с нагревателя, за инсталиране и използване на нагревателя.

Нагревателят може да бъде свързан към захранването само от оторизиран електротехник в съответствие с приложимите разпоредби.

Бележки:

F30310

Szerelési és kezelési útmutató

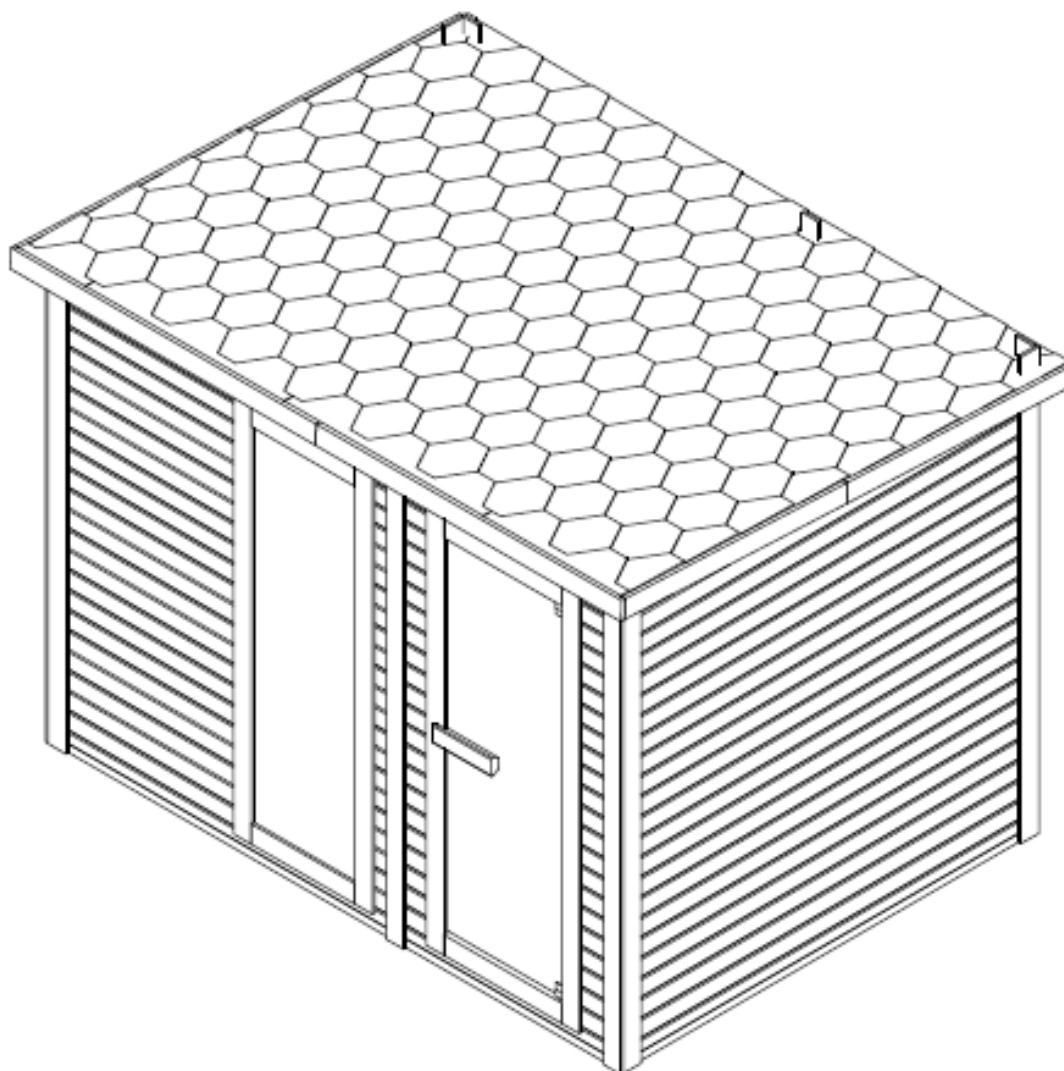

Előszó

Köszönjük, hogy a SANOTECHNIK termékét választotta. Kérjük, összeszerelés előtt figyelmesen olvassa el ezt a kézikönyvet és őrizze is meg. Kérjük, jegyezze fel a sorozatszámokat, mivel erre egy esetleges javítás vagy cserealkatrészek rendelése során szüksége lesz.

Csak eredeti alkatrészeket használjon!

FIGYELEM!

Az elektromos bekötést és javítást csak szakképzett villanszerelő végezheti!

A szaunát kültéren, vízszintes és stabil felületre kell elhelyezni, amely elbírja a szauna súlyát.

A szauna közelében ne legyen vízvételi forrás vagy éghető anyagok.

Az összeszereléshez minimálisan szükséges magasság: 2 m

SZERELÉSI ÚTMUTATÓ

Szerelési tippek

Kérjük, hogy a termék kicsomagolása után, de még az összeszerelés előtt ellenőrizze, hogy minden rész és alkatrész hiánytalanul és sértetlenül rendelkezésre áll.

A szauna összeszereléséhez legalább 2 személyre van szükség.

Kérjük, ellenőrizze a furatok mélységét és átmérőjét, hogy elkerülje a fa sérülését.

Szükséges szerszámok

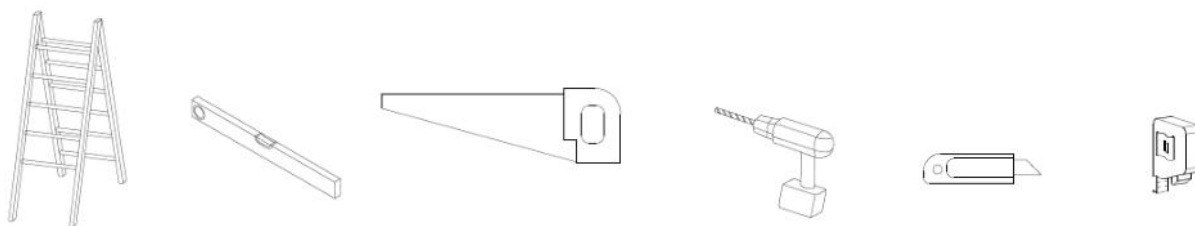





Műszaki adatok

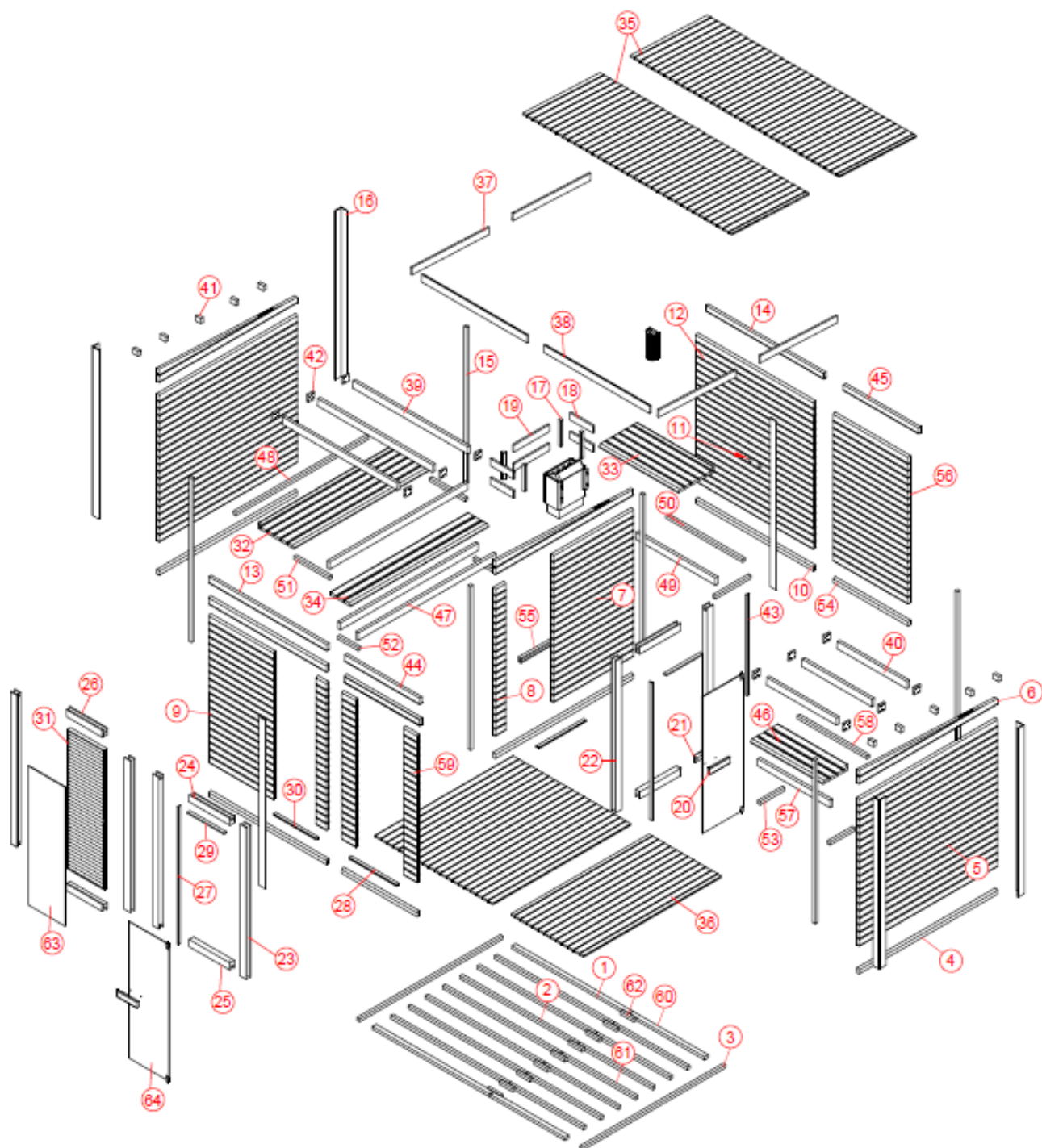

Modell	F30310
Anyaga	lucfenyő
Hosszúság	2300 mm
Szélesség	3100 mm
Magasság	2195 mm
Feszültség	AC 220V / 380V
A szaunakályha teljesítménye	8 kW











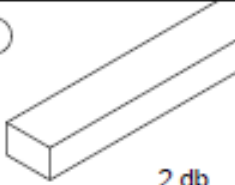
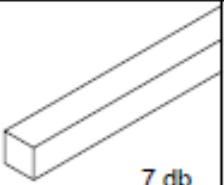
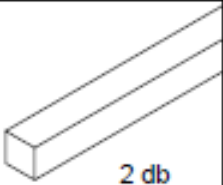
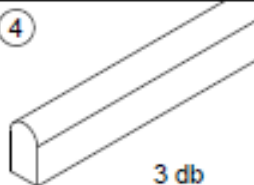
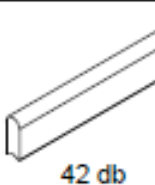

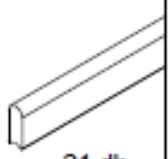
A szauna részei

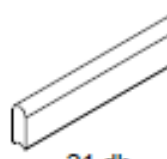
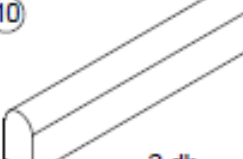
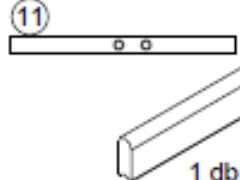
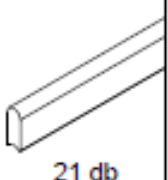
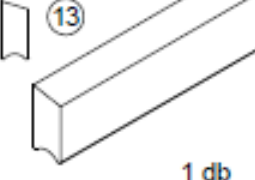
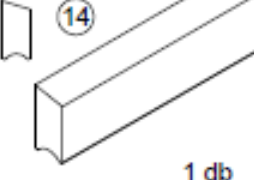
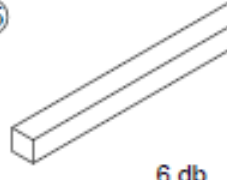
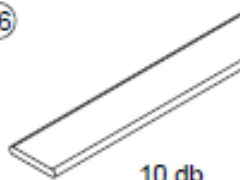
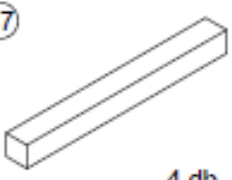
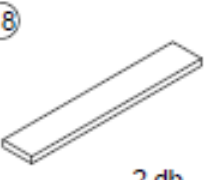
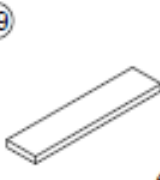
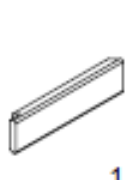
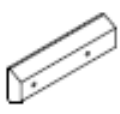
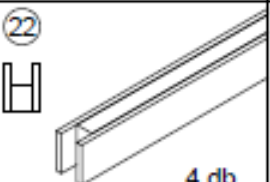
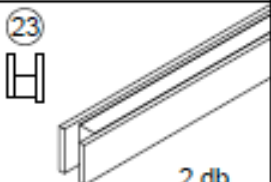

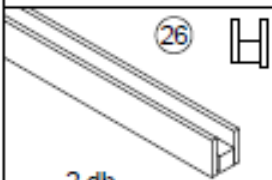
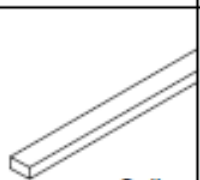
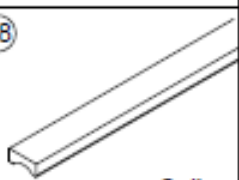
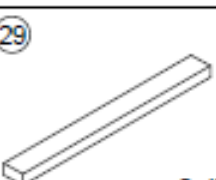
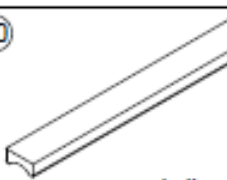

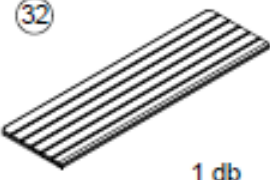
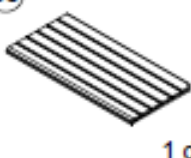

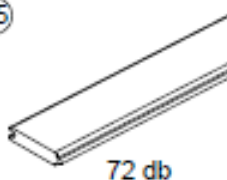
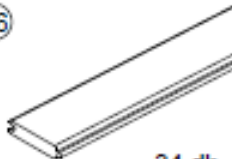

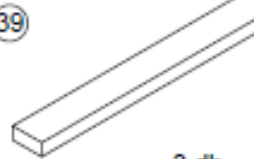
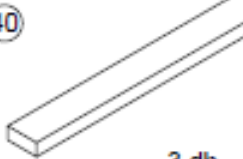





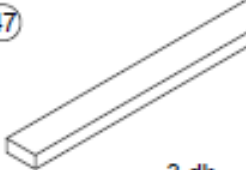
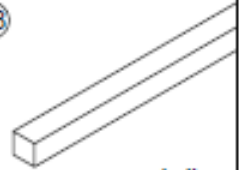
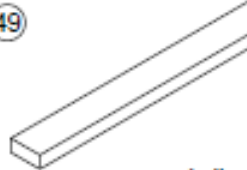
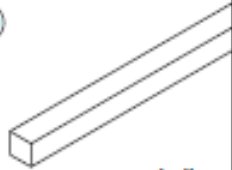
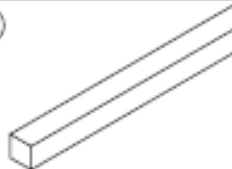
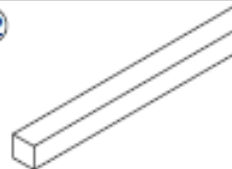
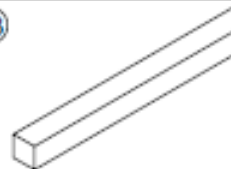

Alkatrészek (eltérés lehetséges)

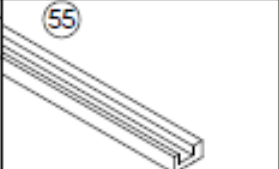
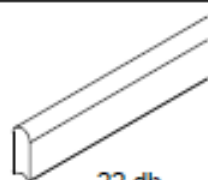
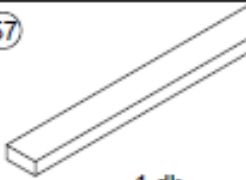
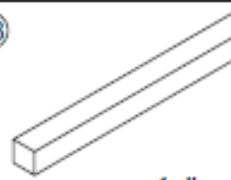
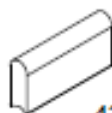
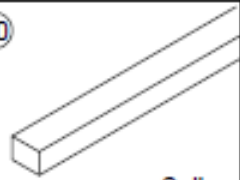
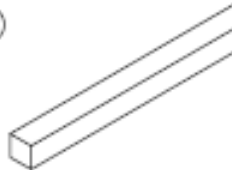
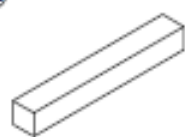
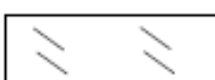
										
Ø3x16	Ø4x70	Ø4x60	Ø4x50	Ø4*40	Ø4*30	Ø4*18	Ø5*100	Ø6x60	Wood peg	
6x	103x	300x	76x	240x	62x	40x	2x	4x	2x	2x

		
2x	10x	2x

①  2 db 1724*55*38 mm	②  7 db 1724*38*38 mm	③  2 db 2100*38*38 mm	④  3 db 2024*67*38 mm	⑤  42 db 2024*97*38 mm
⑥  3 db 2024*168*38 mm	⑦  21 db 1172*97*38 mm	⑧  42 db 150*97*38 mm	⑨  21 db 945*97*38 mm	⑩  2 db 1724*67*38 mm
⑪  1 db 1724*97*38 mm	⑫  21 db 1724*97*38 mm	⑬  1 db 1724*81*38 mm	⑭  1 db 1724*70*38 mm	⑮  6 db 2188*38*38 mm
⑯  10 db 2140*90*13 mm	⑰  4 db 330*33*33 mm	⑱  2 db 520*90*20 mm	⑲  4 db 340*90*20 mm	⑳  1 db 300*90*40 mm
㉑  1 db 252*90*40 mm	㉒  4 db 1927*90*66 mm	㉓  2 db 1927*90*66 mm	㉔  2 db 600*90*66 mm felső	㉕  2 db 600*90*66 mm alsó
㉖  2 db 547*90*66 mm	㉗  2 db 1747*40*13 mm	㉘  2 db 700*38*17 mm	㉙  2 db 537*40*13 mm	㉚  1 db 627*38*17 mm
㉛  1 db 1765*545*47 mm	㉜  1 db 2022*560*33 mm	㉝  1 db 1162*560*33 mm	㉞  1 db 2022*300*33 mm	㉟  72 db 1130*97*18 mm
㊱  34 db 2022*97*18 mm	㊲  4 db 1132*90*20 mm	㊳  2 db 1552*90*20 mm	㊴  3 db 1684*90*38 mm	㊵  3 db 1022*90*38 mm

<p>41</p>  <p>10 db</p> <p>80*60*38 mm</p>	<p>42</p>  <p>12 db</p> <p>90*90*20 mm</p>	<p>43</p>  <p>1 db</p> <p>1550*33*13 mm</p>	<p>44</p>  <p>1 db</p> <p>1100*81*38 mm</p>	<p>45</p>  <p>1 db</p> <p>1100*70*38 mm</p>
<p>46</p>  <p>1 db</p> <p>1060*400*33 mm</p>	<p>47</p>  <p>3 db</p> <p>2022*90*38 mm</p>	<p>48</p>  <p>1 db</p> <p>1946*38*38 mm</p>	<p>49</p>  <p>1 db</p> <p>1162*90*38 mm</p>	<p>50</p>  <p>1 db</p> <p>1124*38*38 mm</p>
<p>51</p>  <p>3 db</p> <p>522*38*38 mm</p>	<p>52</p>  <p>2 db</p> <p>300*38*38 mm</p>	<p>53</p>  <p>2 db</p> <p>362*38*38 mm</p>	<p>54</p>  <p>2 db</p> <p>1100*67*38 mm</p>	<p>55</p>  <p>1 db</p> <p>820*40*20 mm</p>
<p>56</p>  <p>22 db</p> <p>1100*97*38 mm</p>	<p>57</p>  <p>1 db</p> <p>1060*90*38 mm</p>	<p>58</p>  <p>1 db</p> <p>1022*38*38 mm</p>	<p>59</p>  <p>42 db</p> <p>198*97*38 mm</p>	<p>60</p>  <p>2 db</p> <p>1100*55*38 mm</p>
<p>61</p>  <p>7 db</p> <p>1100*38*38 mm</p>	<p>62</p>  <p>9 db</p> <p>200*38*38 mm</p>	<p>63</p>  <p>1 db</p> <p>1764*544*6 mm</p>	<p>64</p>  <p>1 db</p> <p>1733*594*6 mm</p>	<p>65</p>  <p>1 db</p> <p>300*142*105 mm</p>
 <p>világítás</p>	 <p>szaunakályha</p>	 <p>69 db</p> <p>1000*320*5 mm</p>		

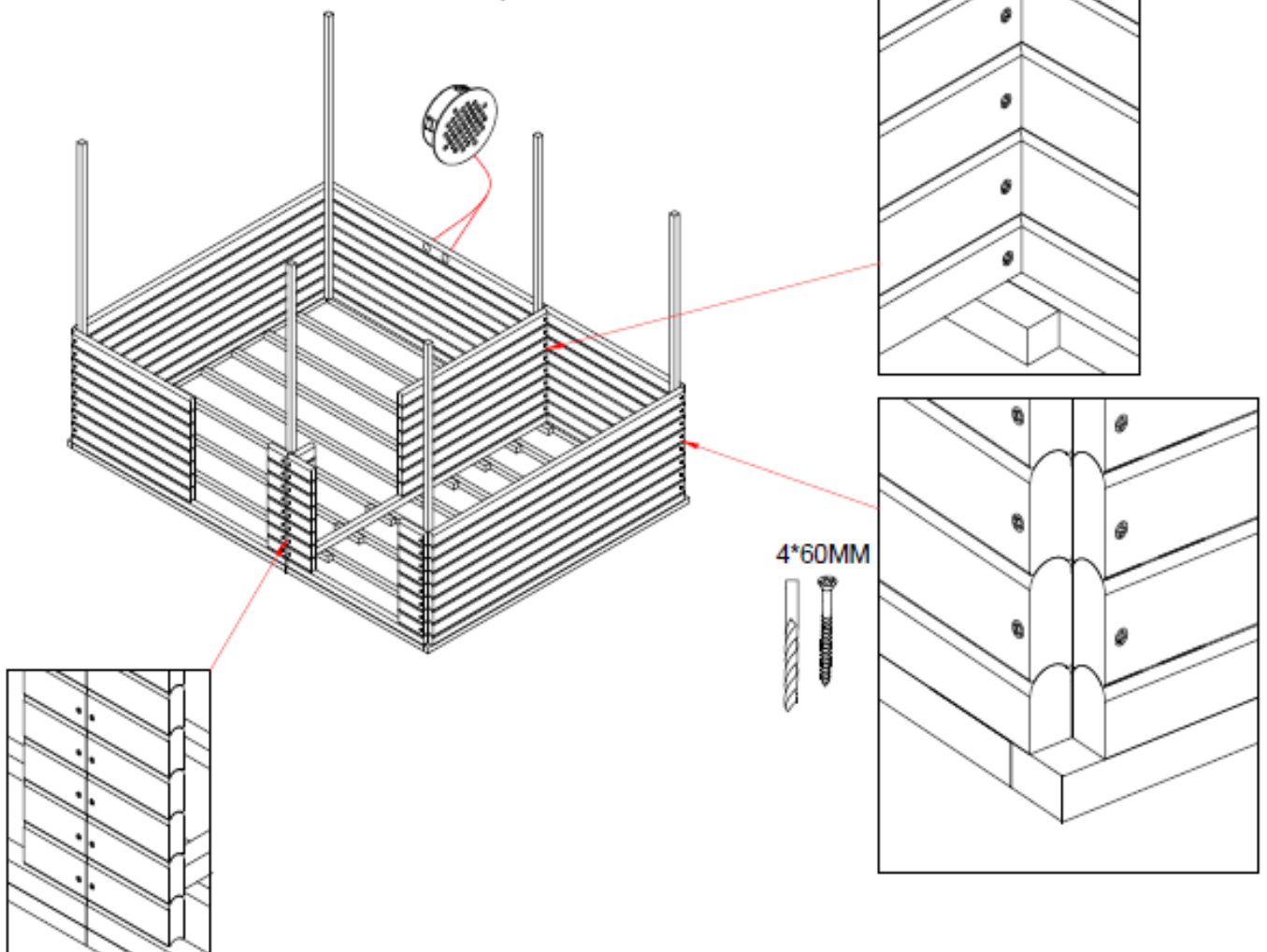
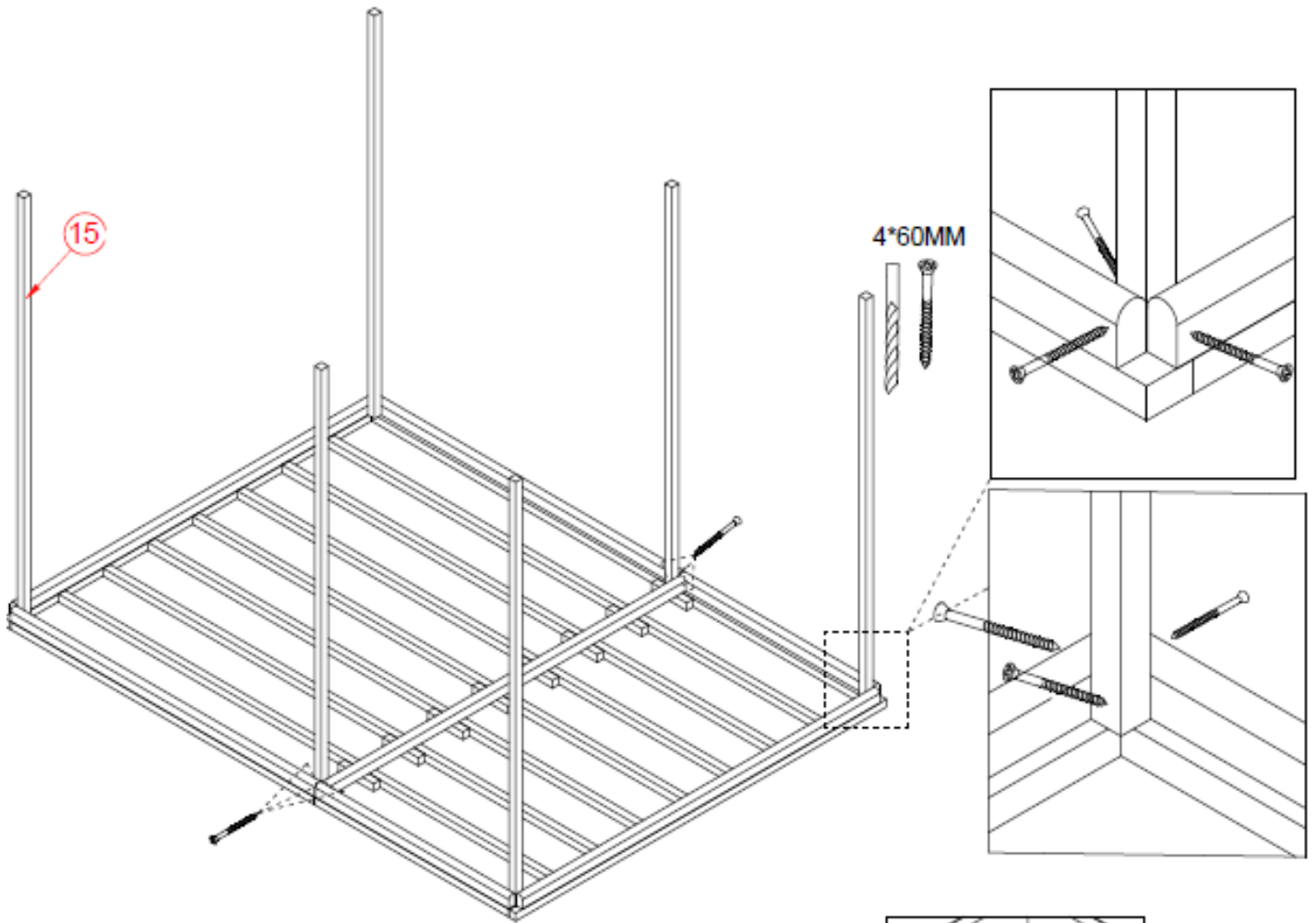

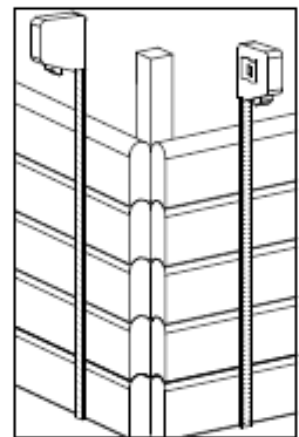
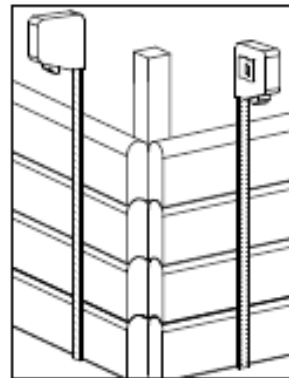
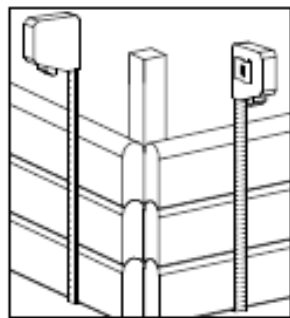
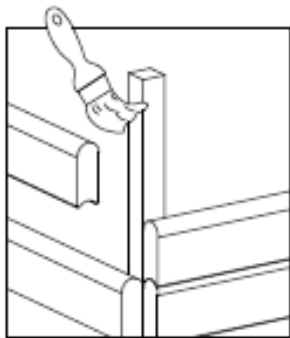
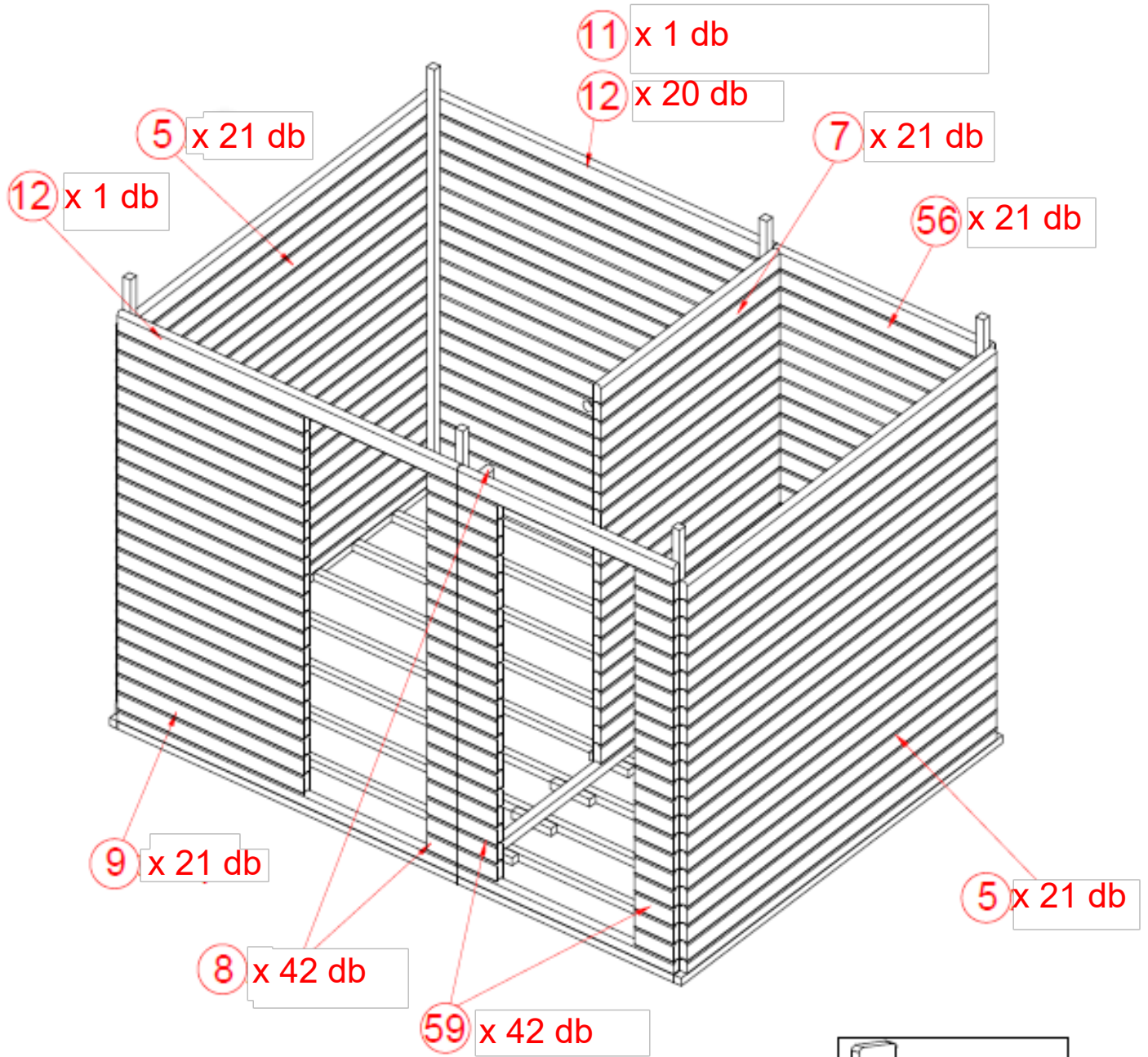

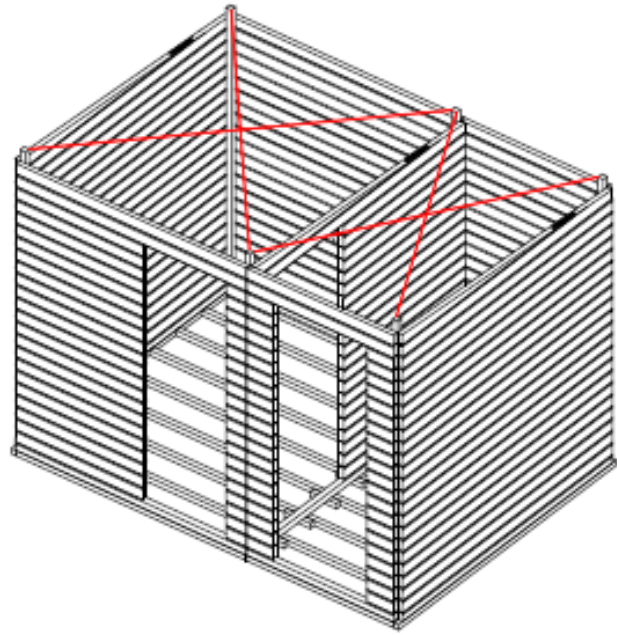

Vágja méretre!

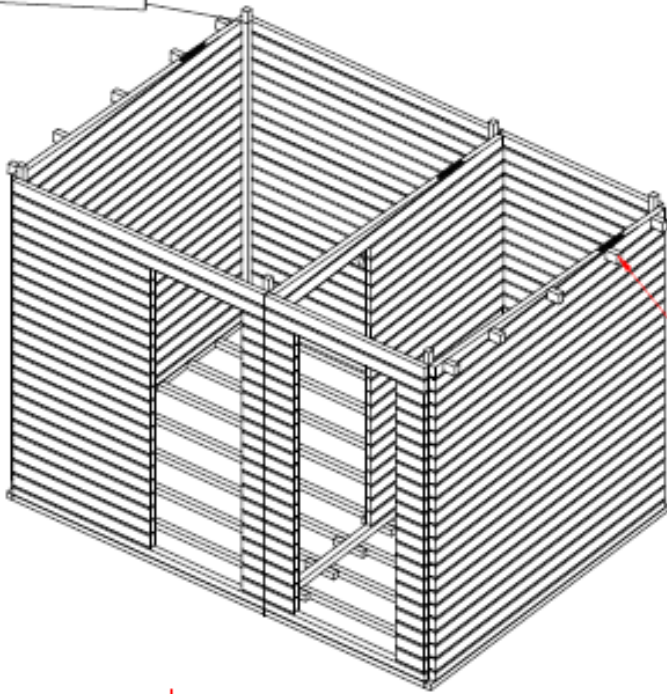

41 x 10 db

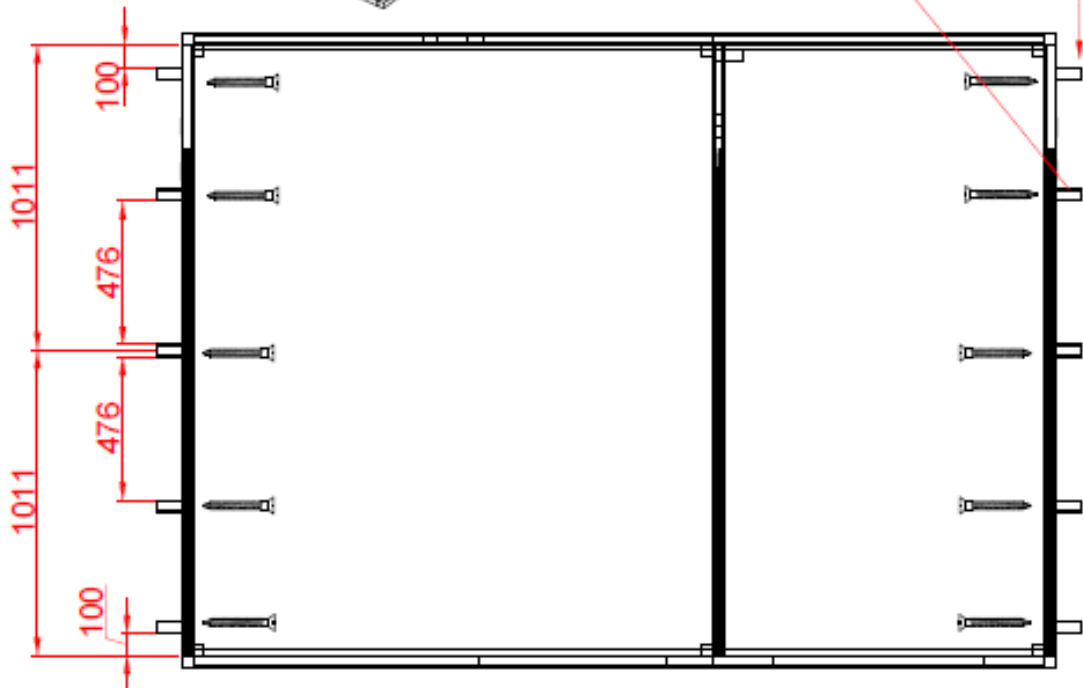

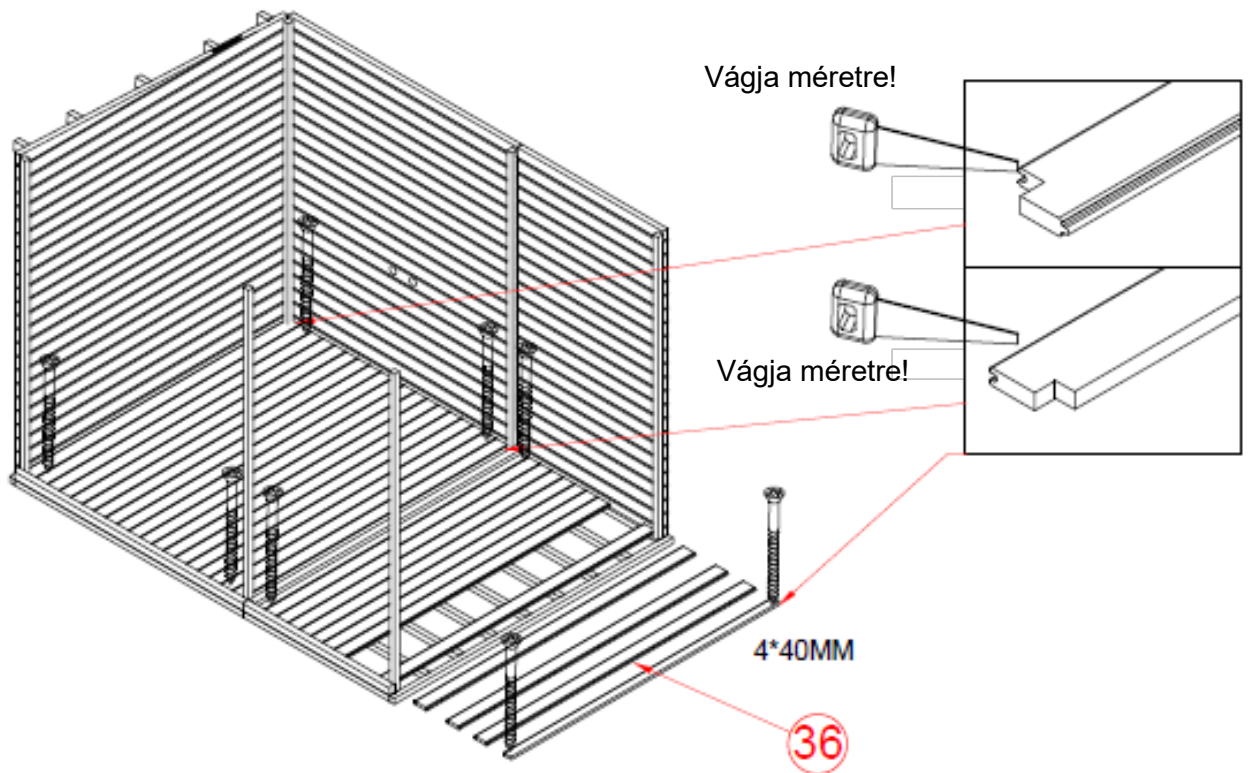
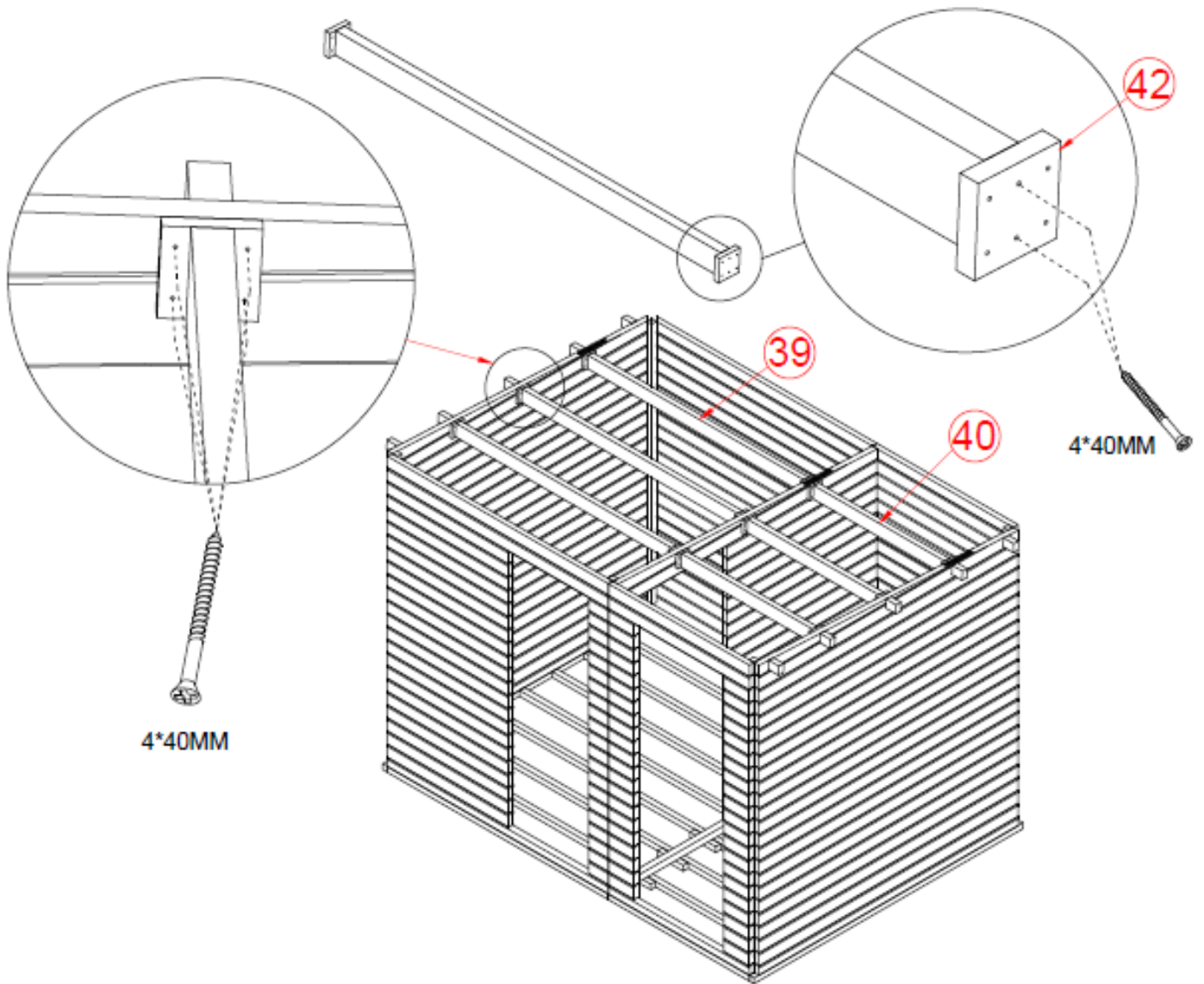

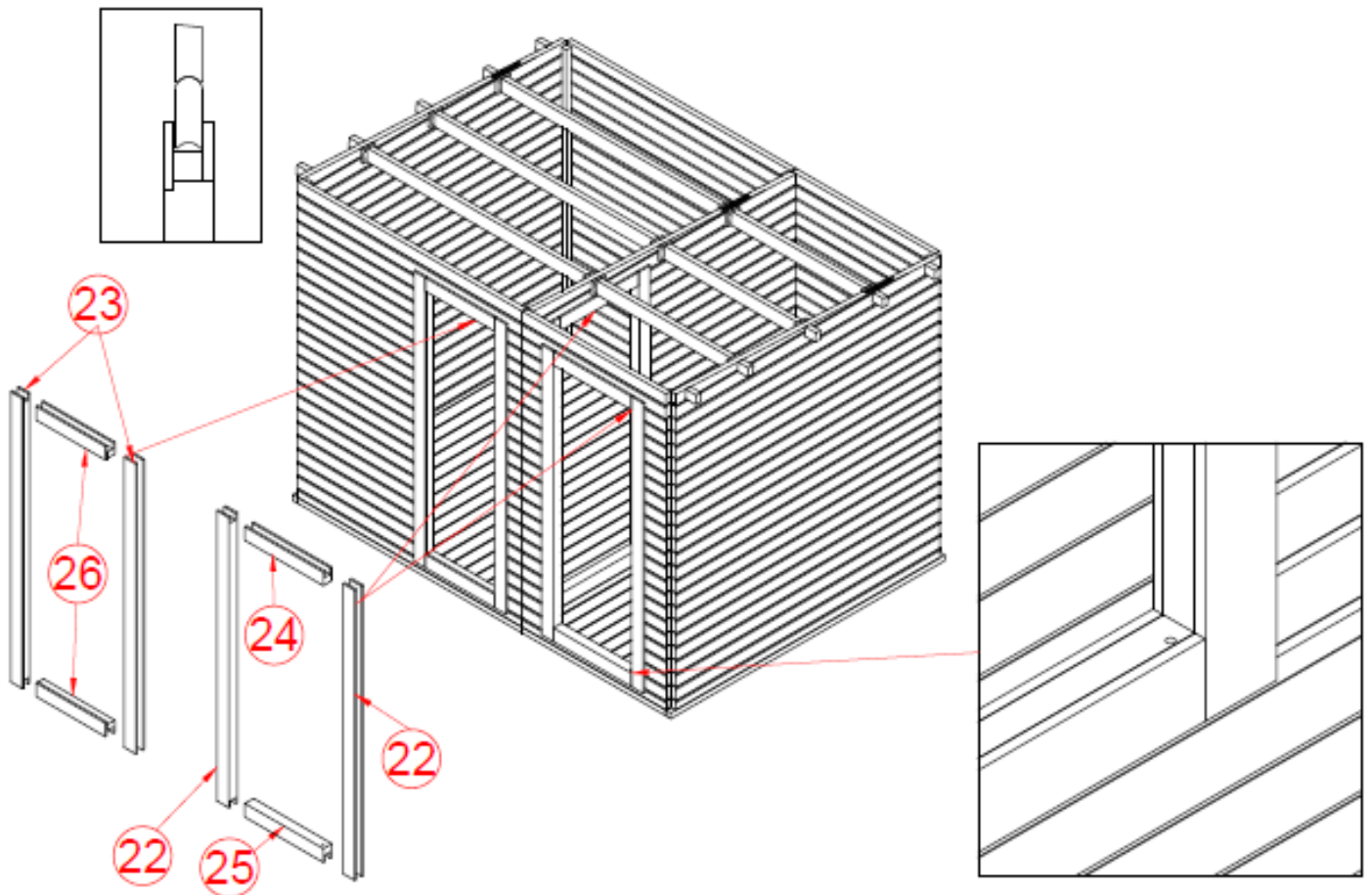
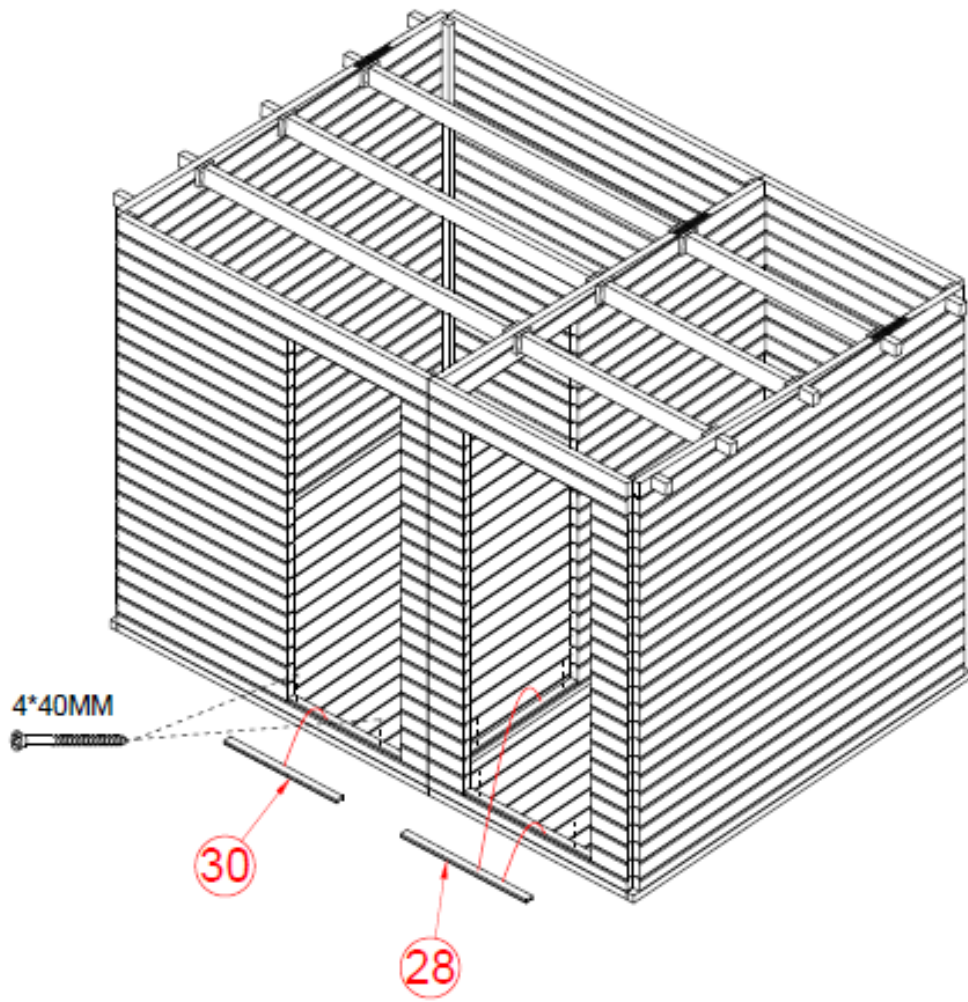

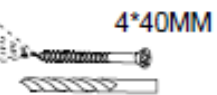
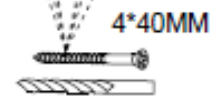
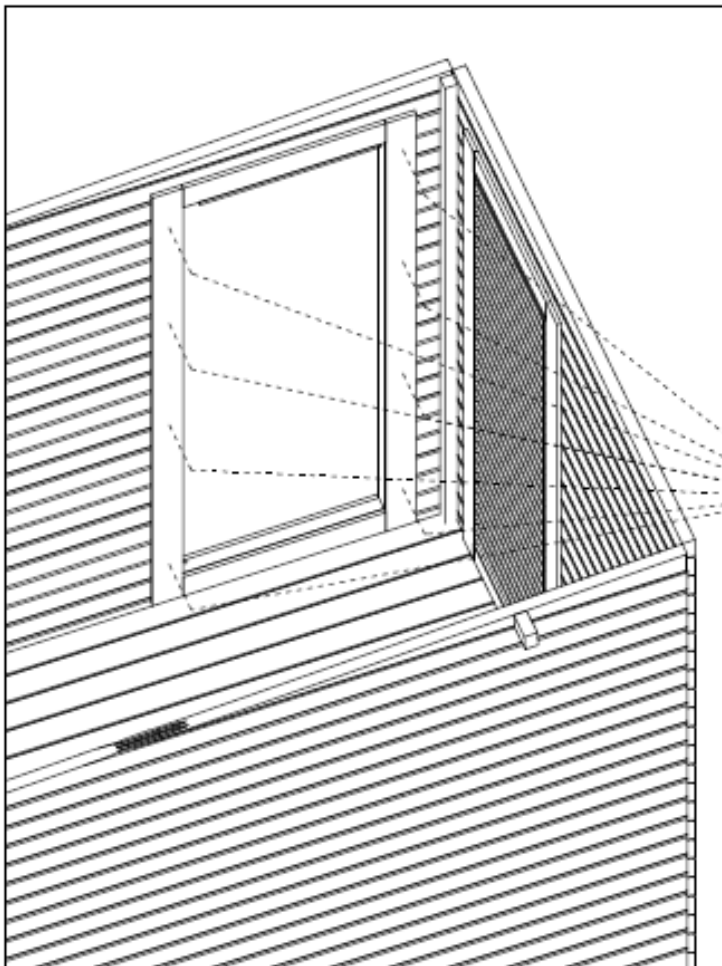
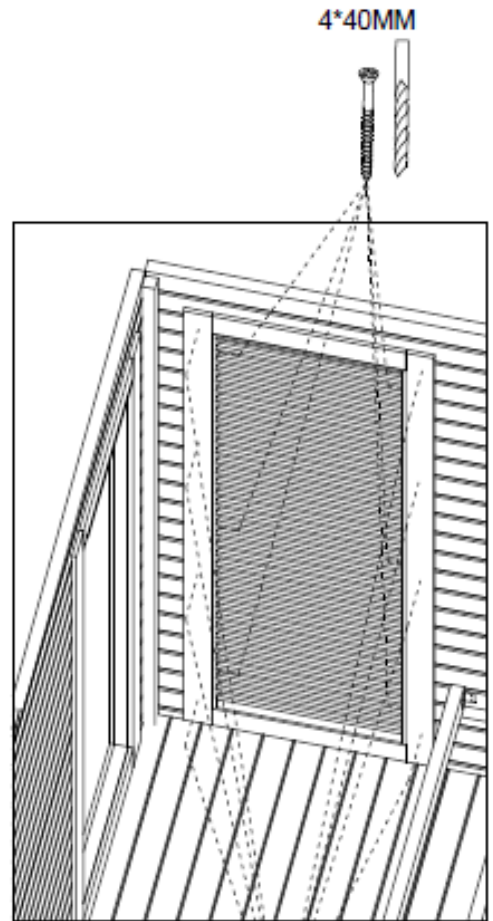
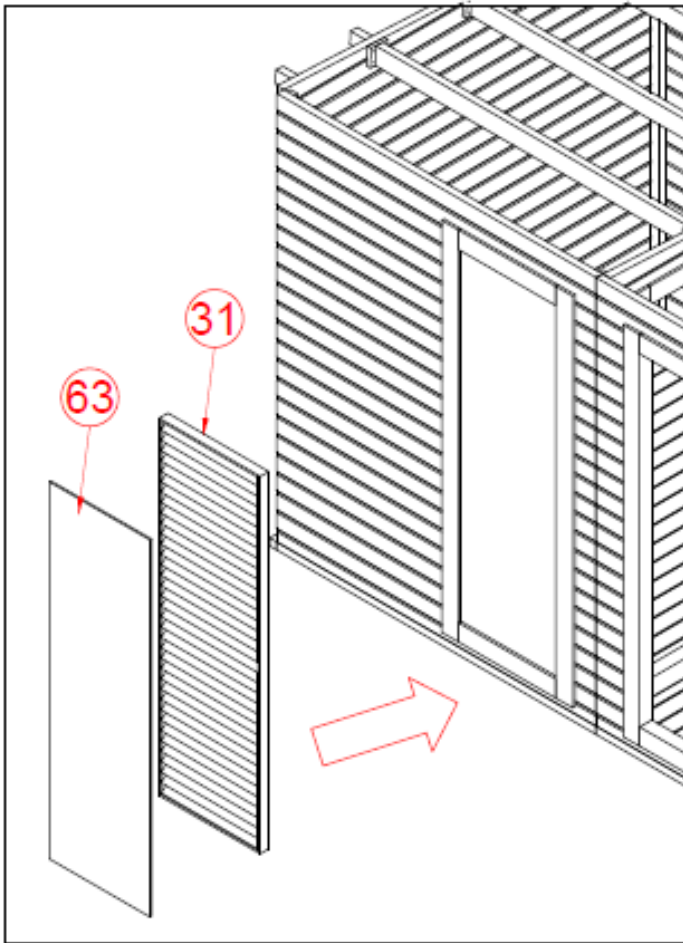

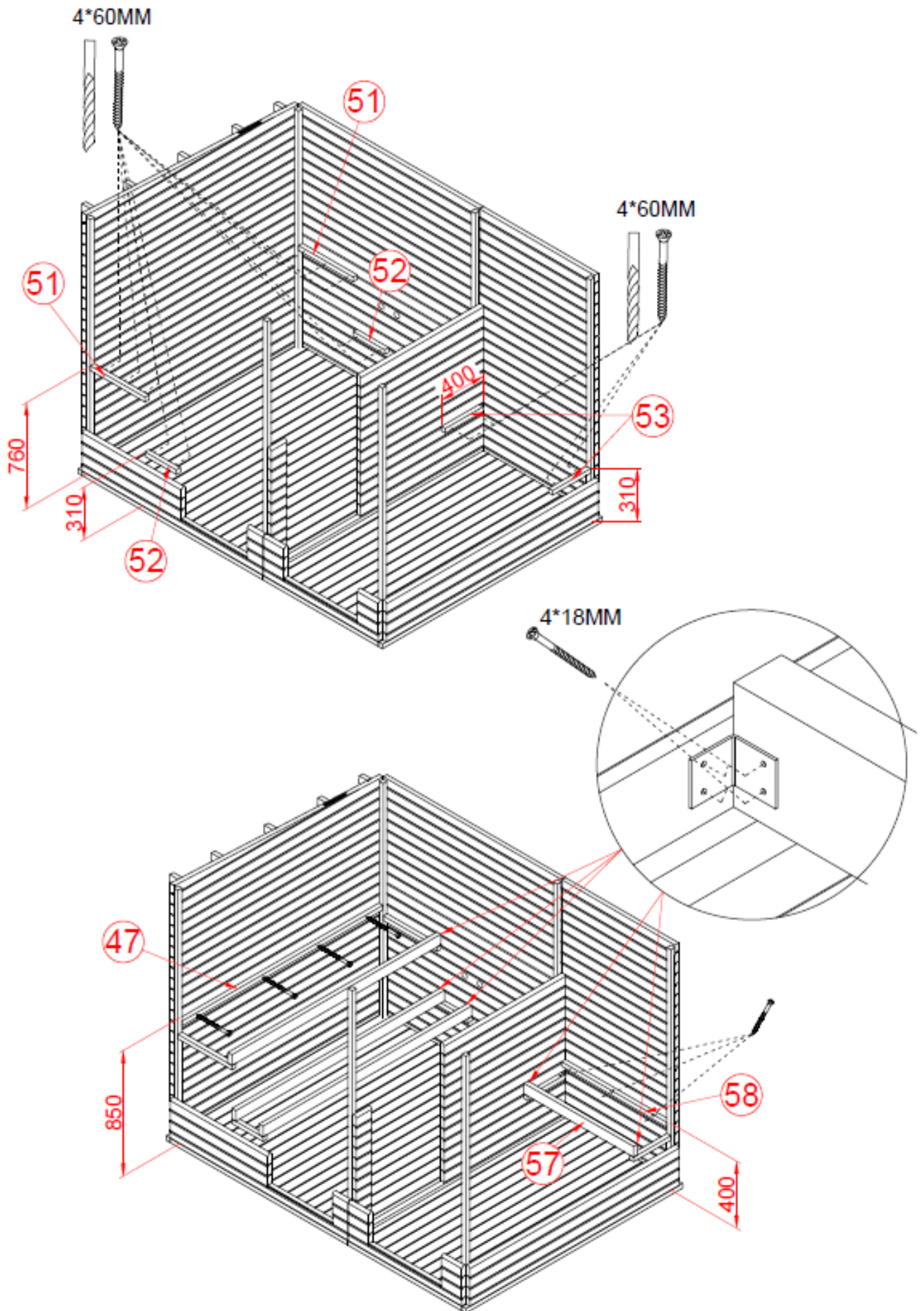

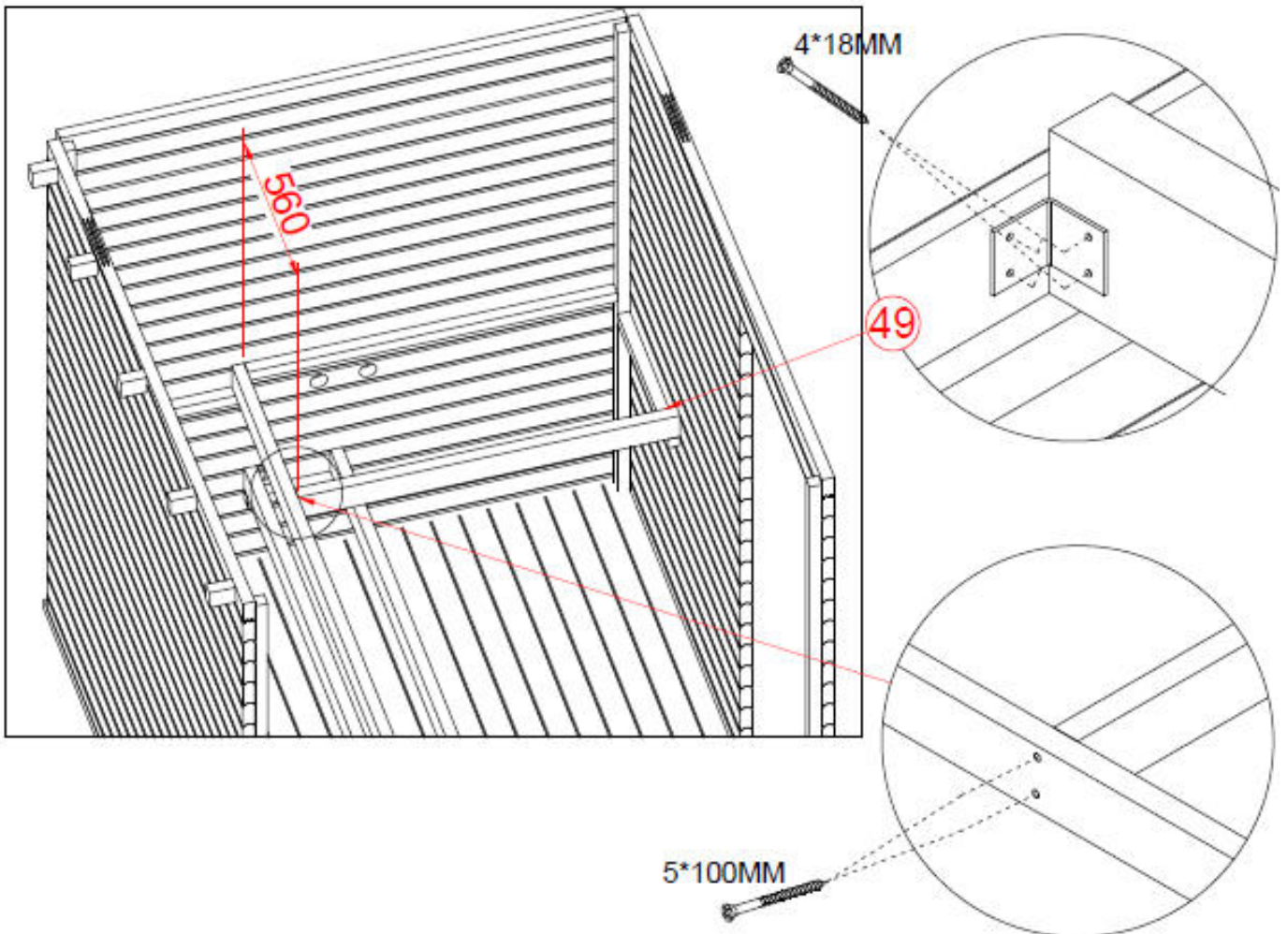
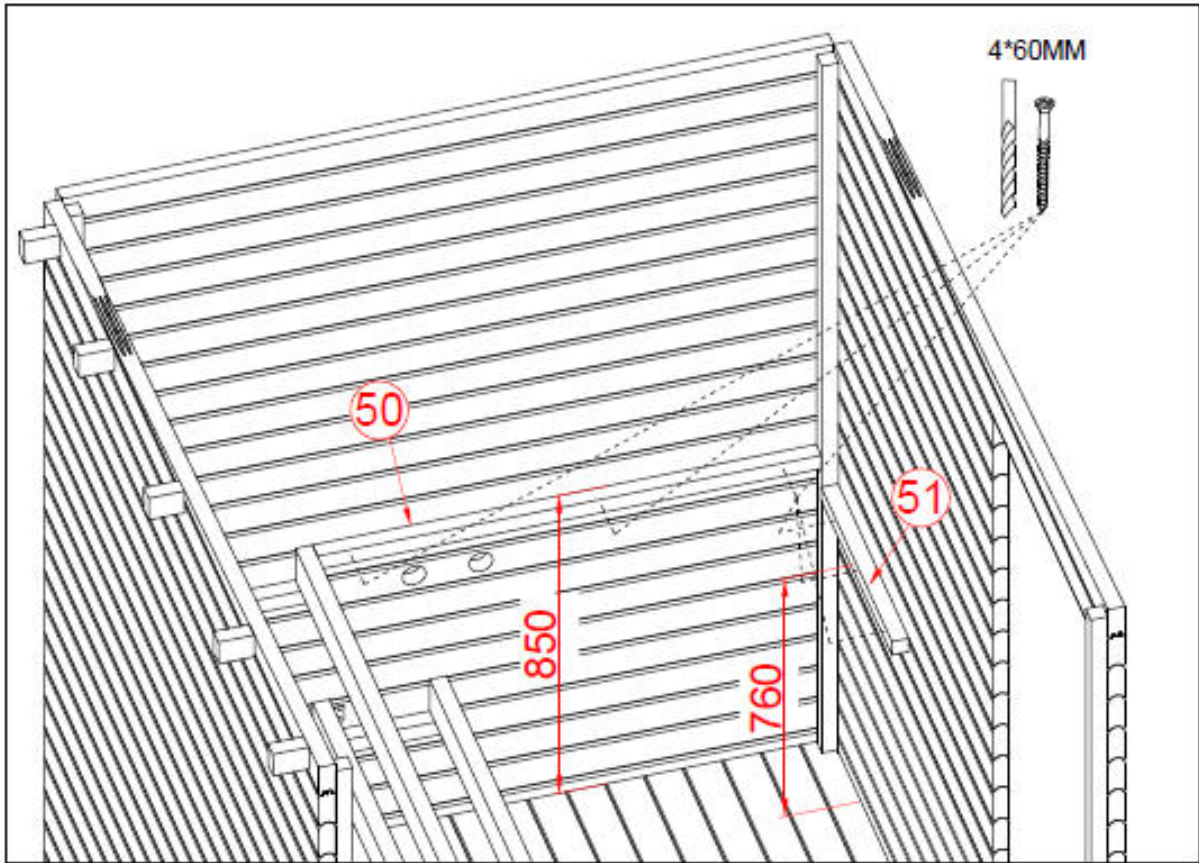

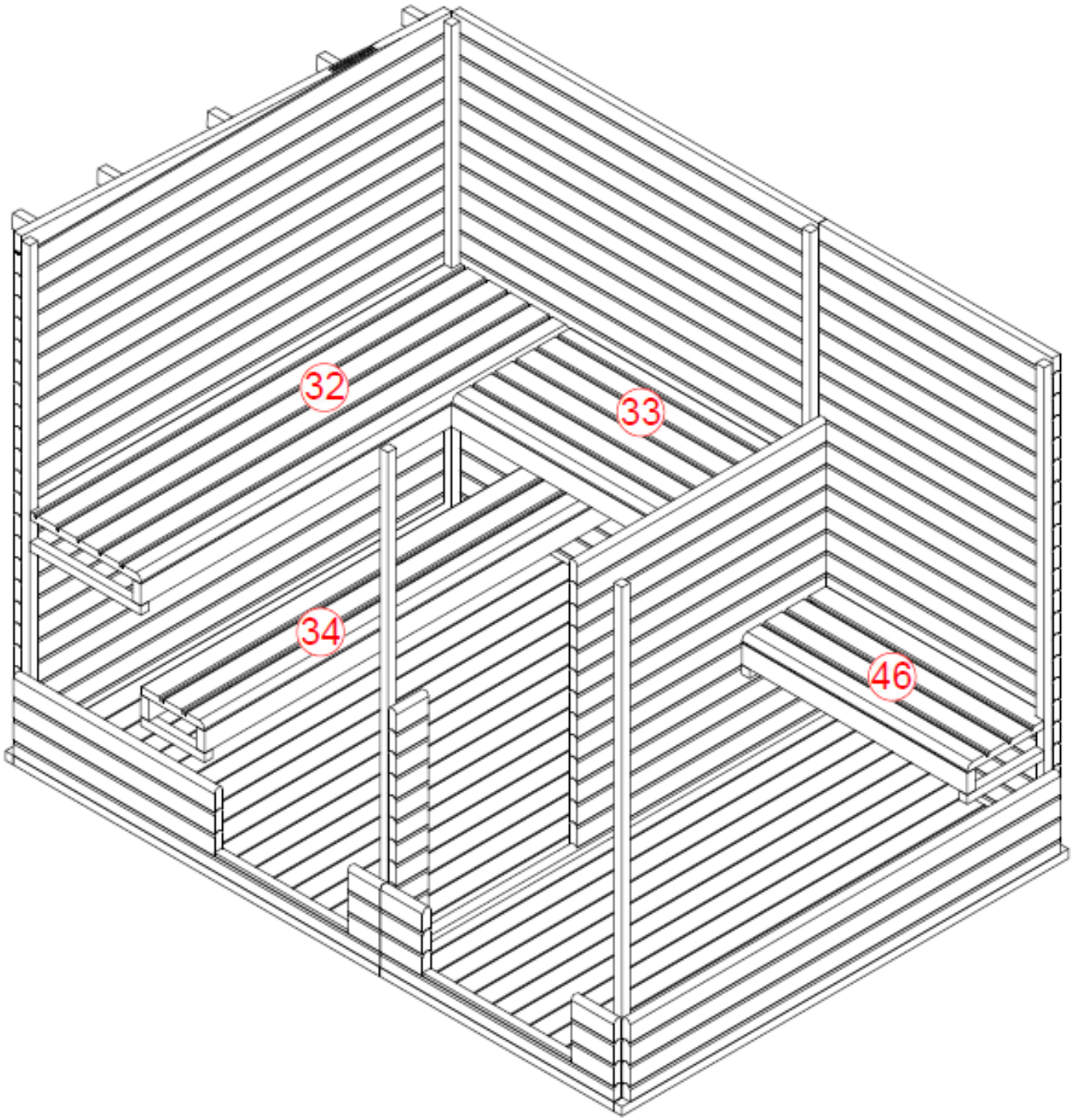

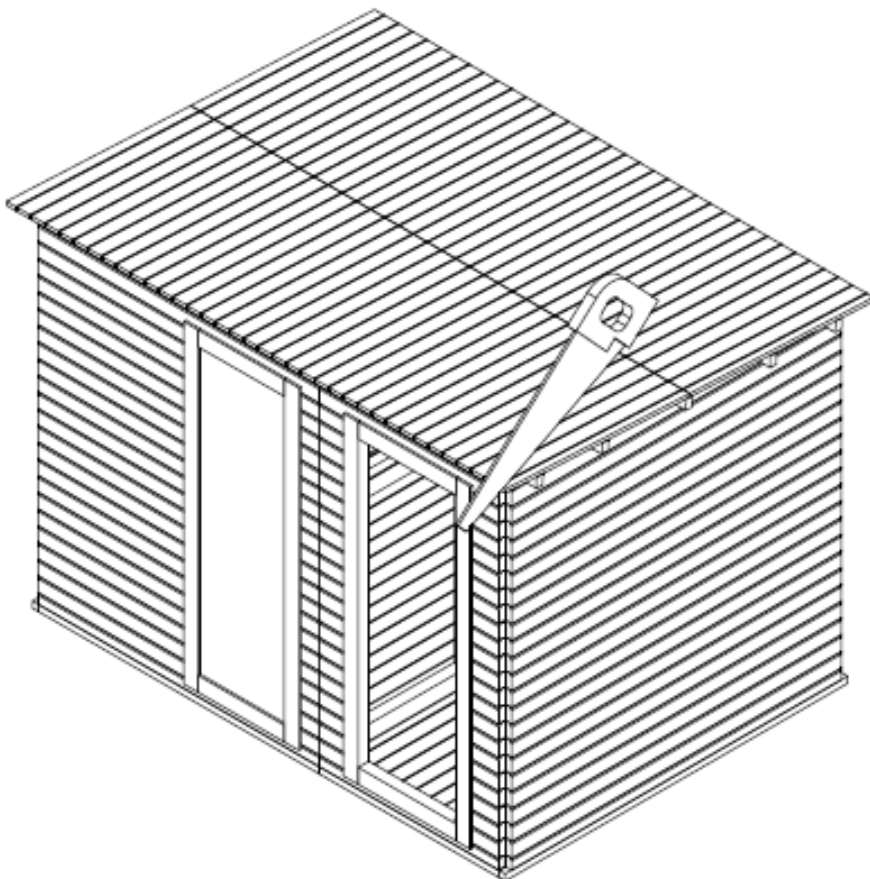
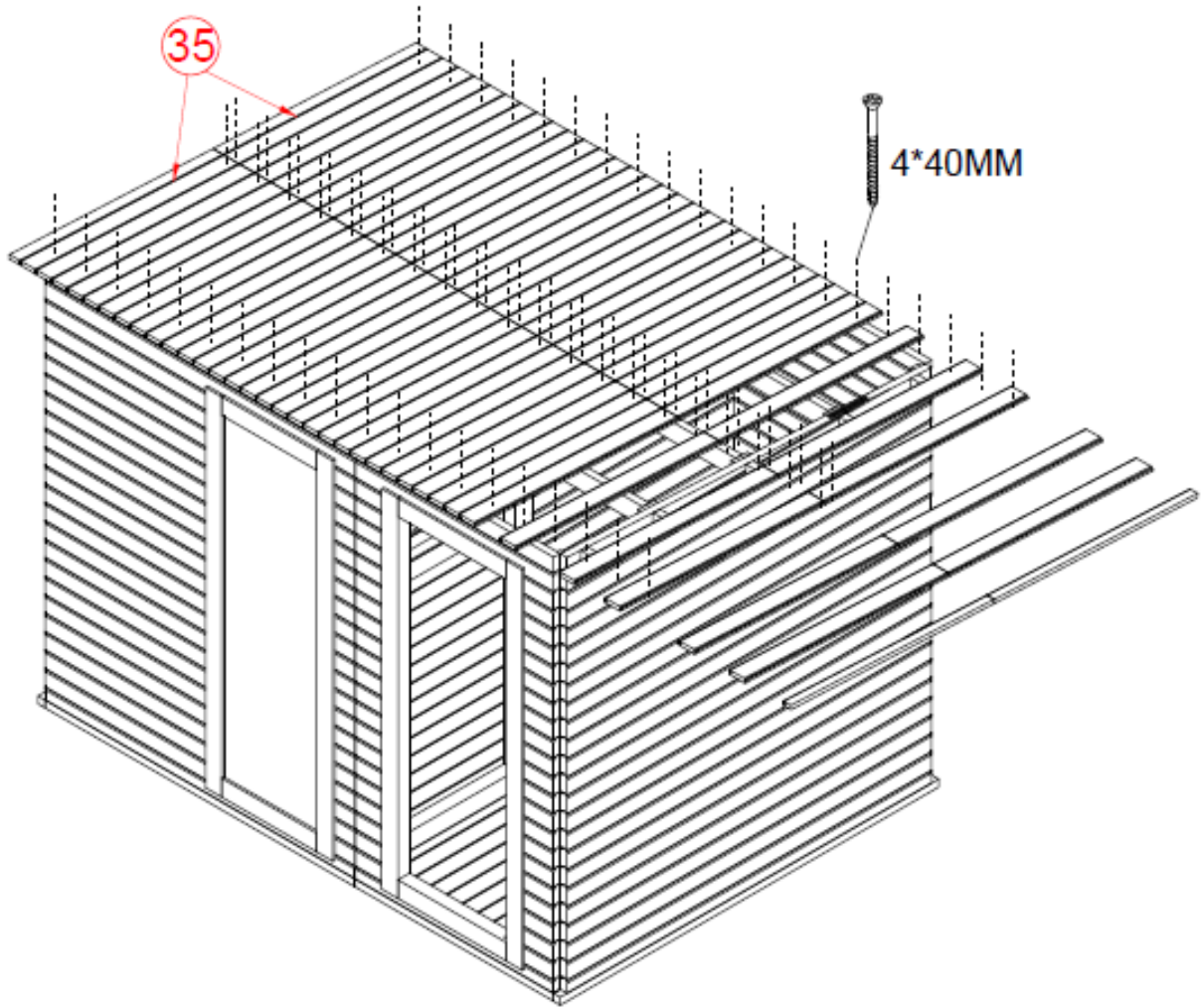

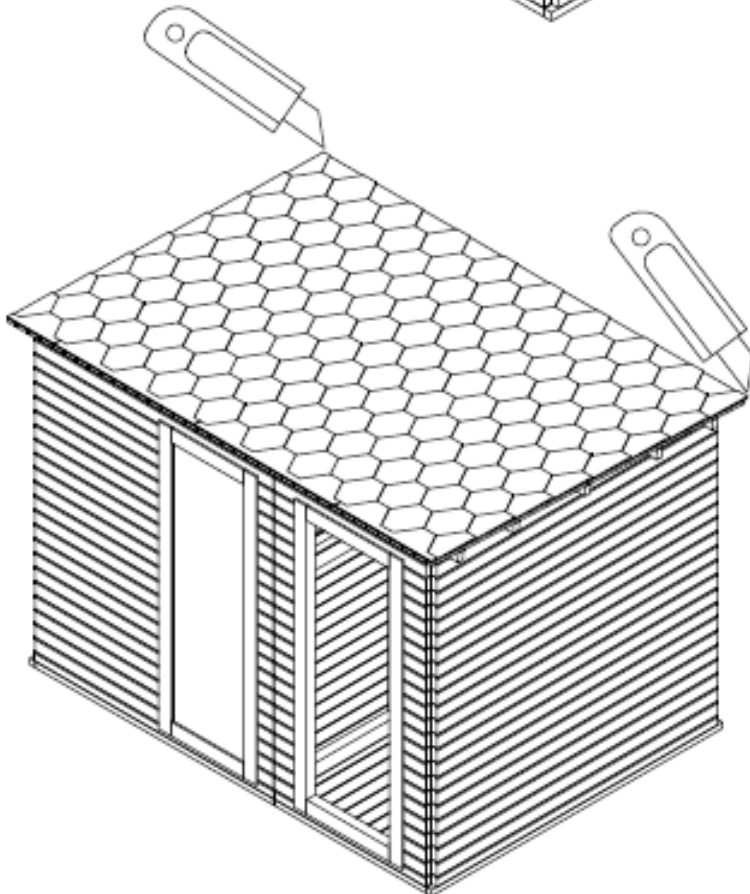
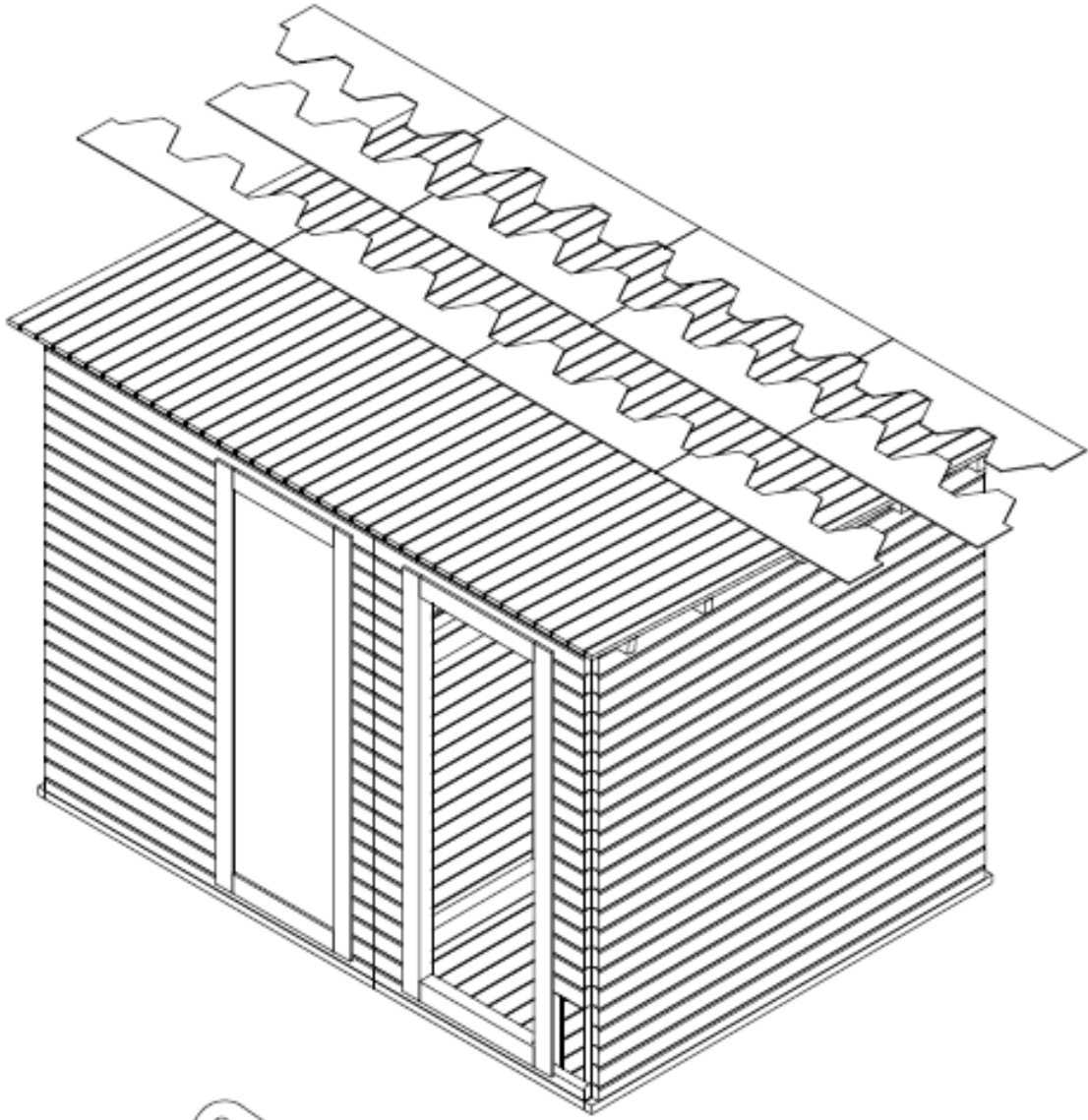

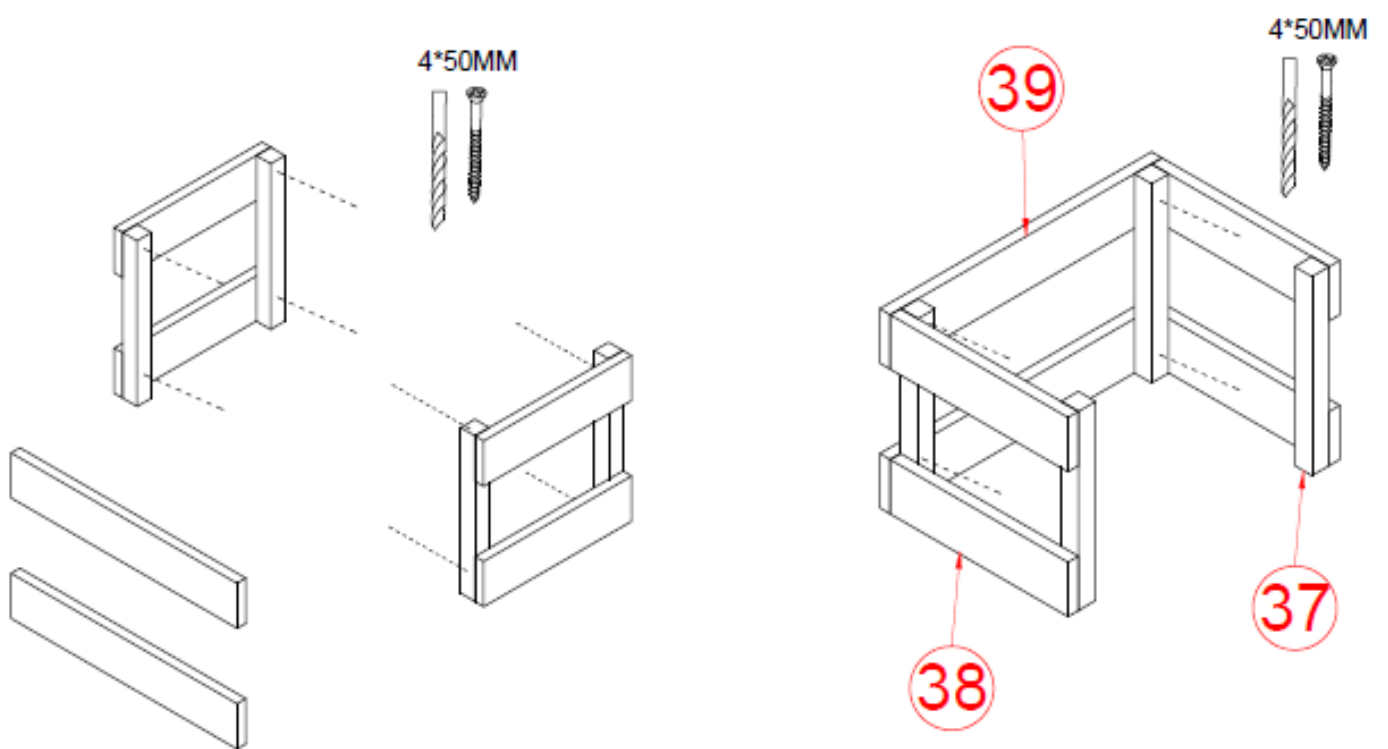
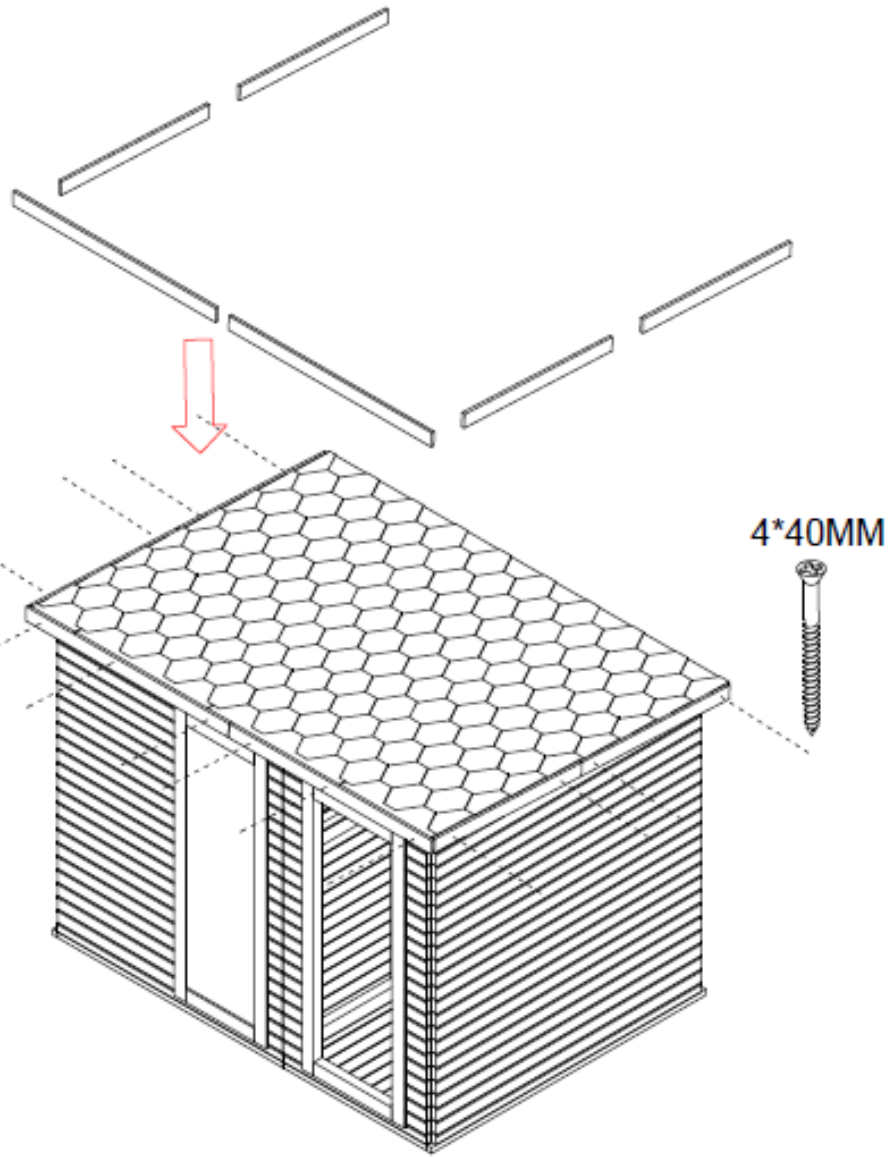

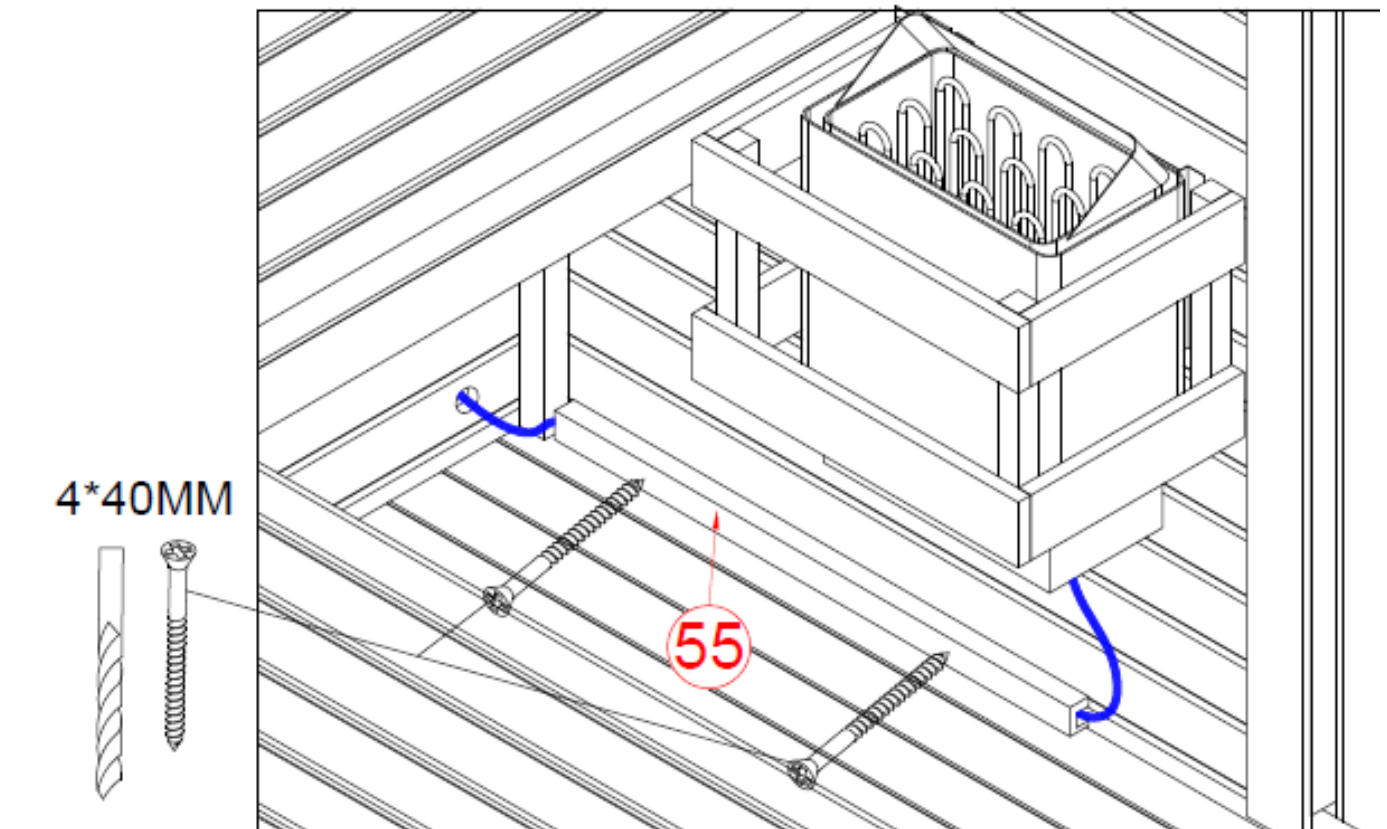
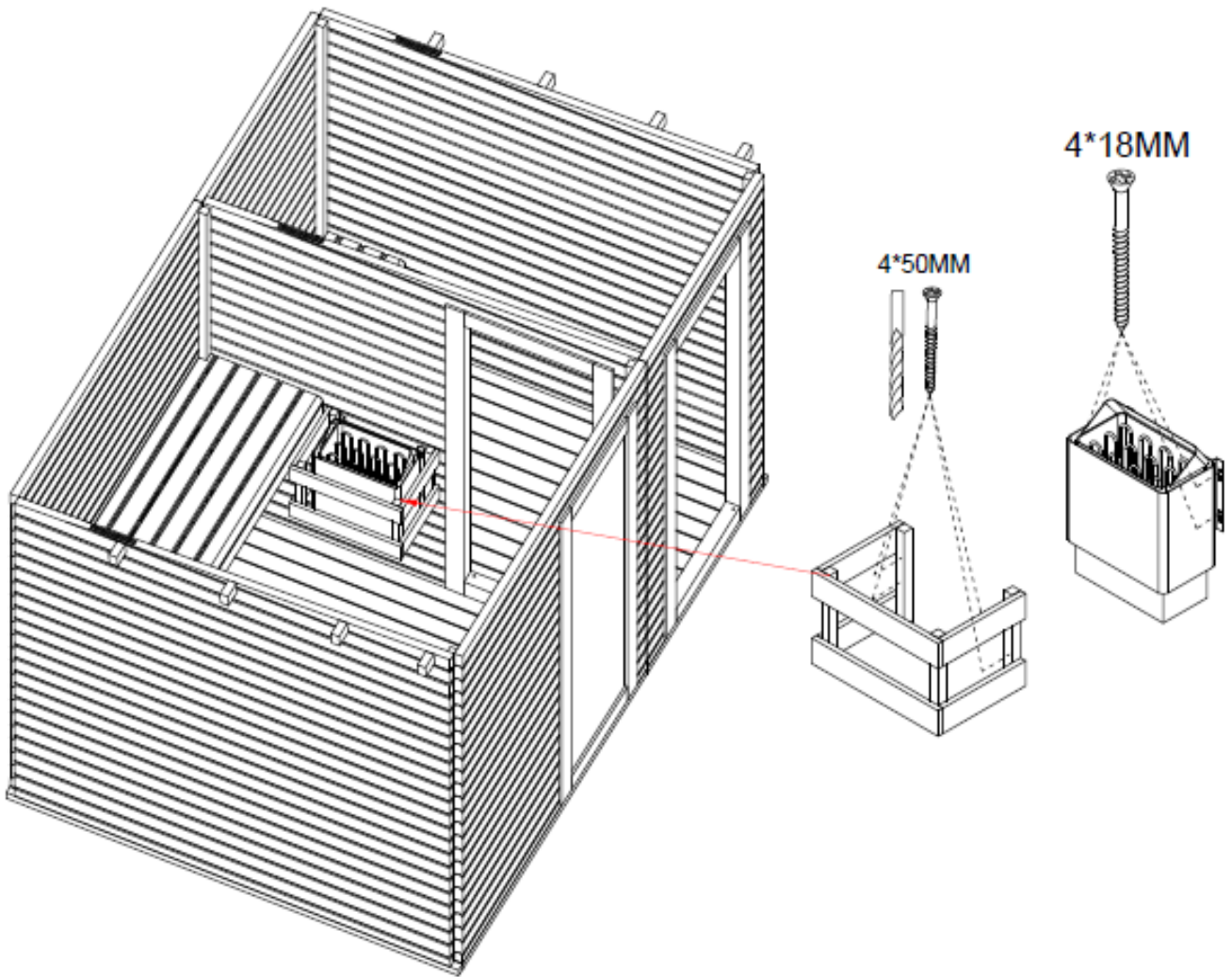

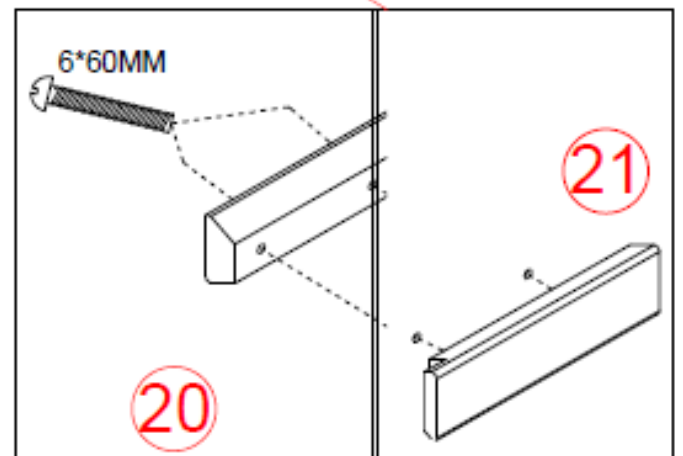
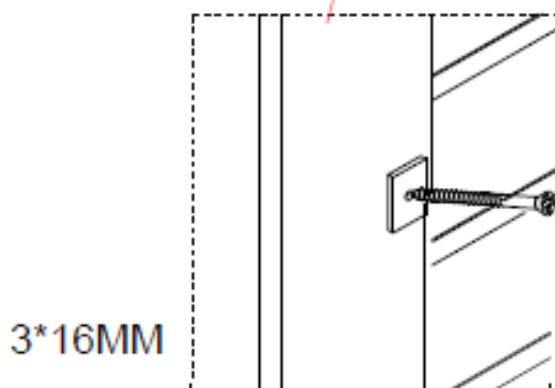
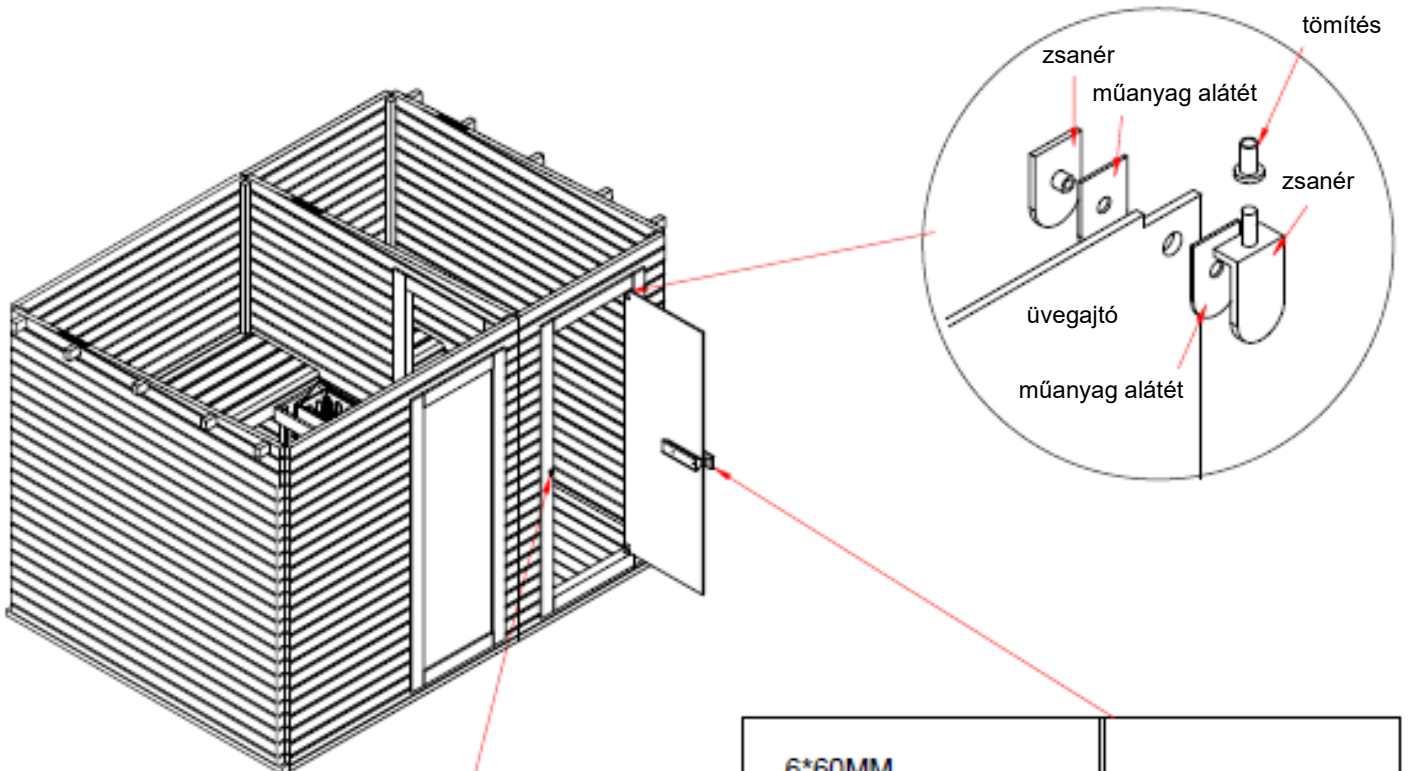
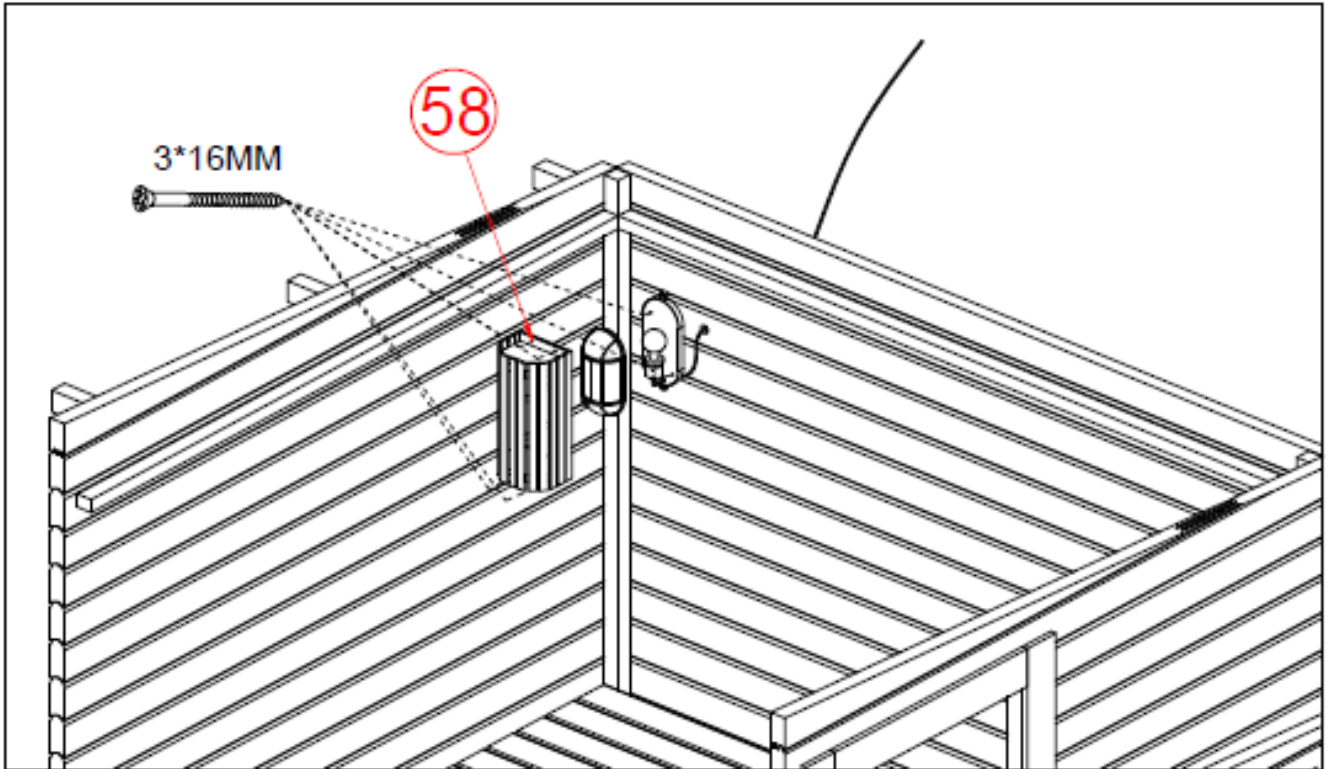

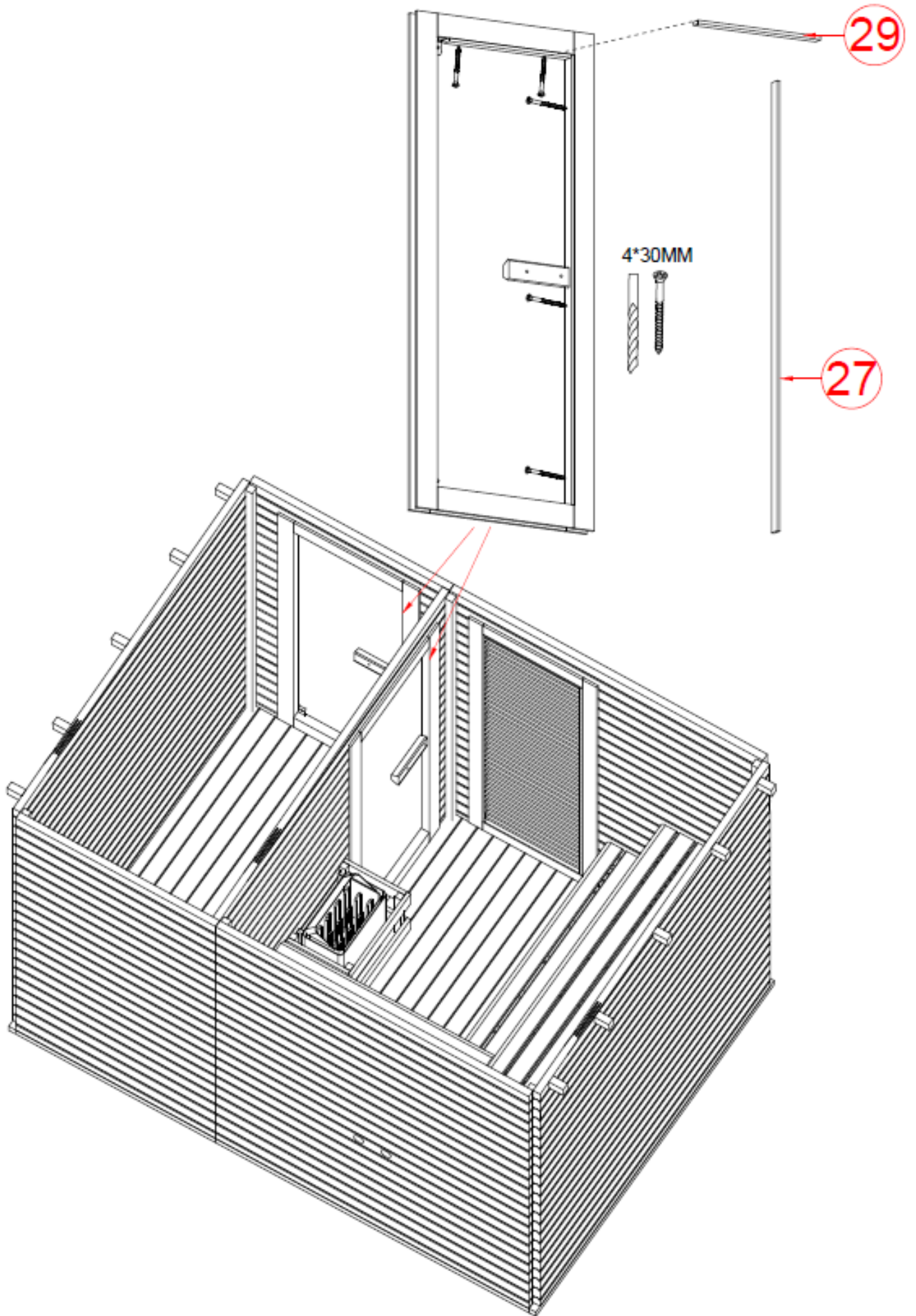

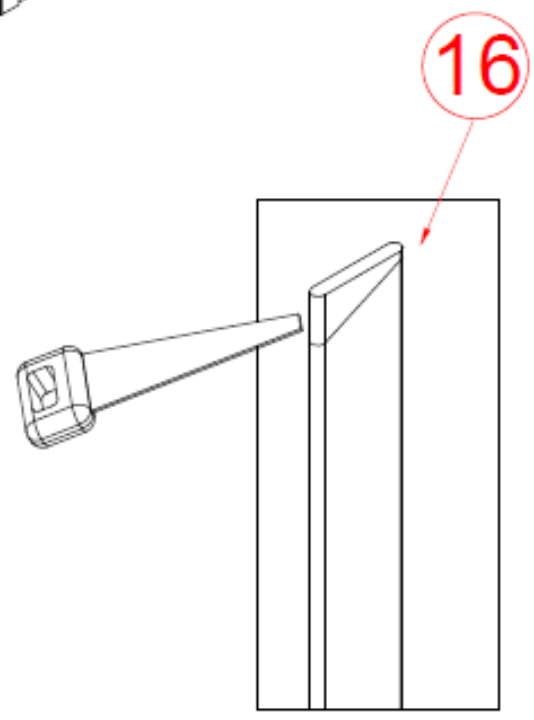
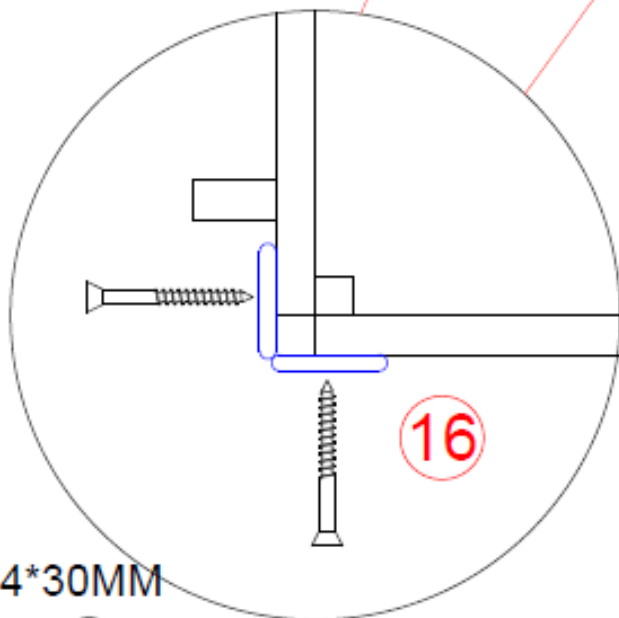
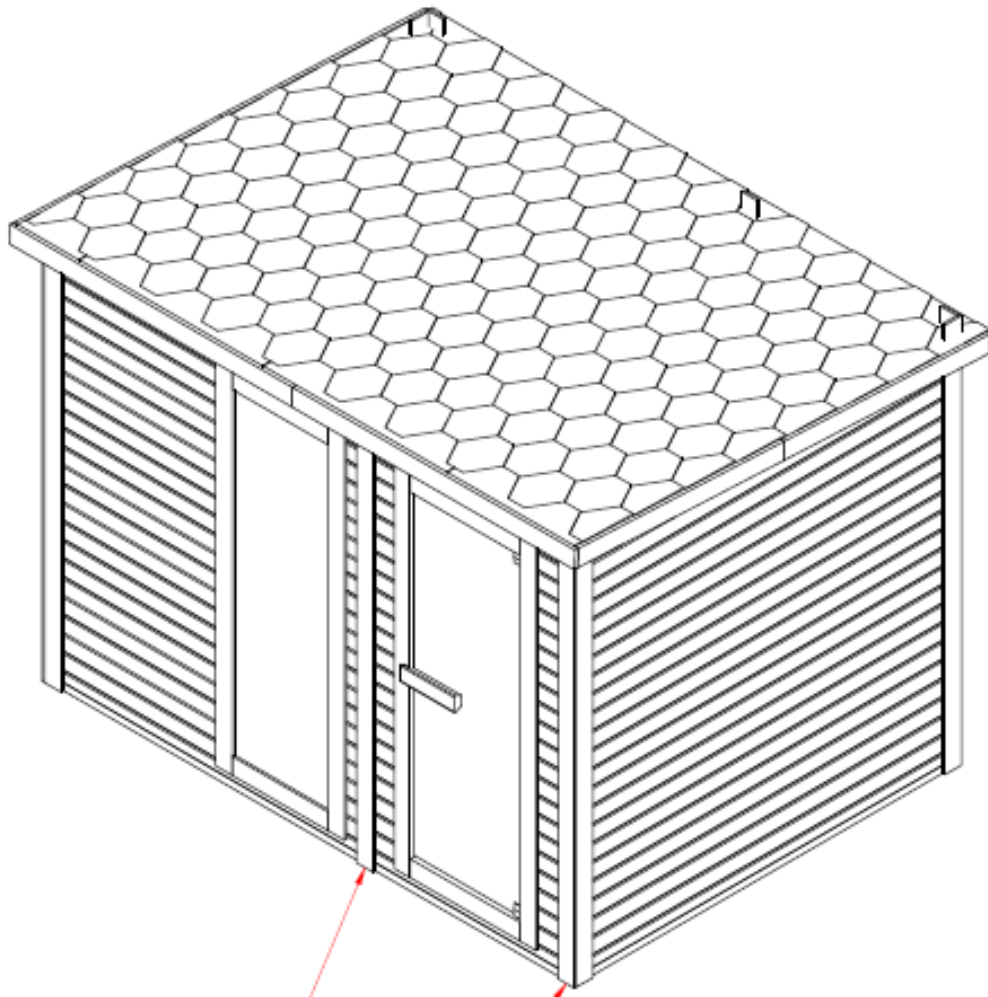

4*30MM

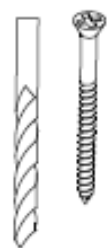

Tisztítás, karbantartás

A szauna külsejét az összeszerelést követően egy kefével tisztítsa meg, majd az állagmegőrzés érdekében és hogy védje azt az időjárási viszontagságoktól (csapadék, napsugárzás), faolajjal kezelje le.

A felújító kezelést évente ajánlott elvégezni.

Egészség- és környezetvédelmi szempontból nem javasoljuk erős kémiai szerek (lazúr, fazománc) használatát.

A szauna belsejét nedves pamutkendővel tisztítsa meg, majd tiszta, száraz ruhával törölje szárazra.

A résekből a port legegyszerűbben porszívóval távolíthatja el.

Ne használjon kémiai tisztítószereket!

Az üvegeket ablaktisztítóval és puha ruhával tisztítsa meg.

Használati és biztonsági útmutató

Kérjük, hogy használat előtt olvassa át az alábbi útmutatót.

Ha kétségei merülnek fel, hogy használhatja-e a szaunát, kérje ki kezelőorvosa véleményét.

Ha szaunázás közben szédülést vagy hőhullámokat tapasztal, azonnal hagyja el a szaunát!!

Kisgyermeket és háziállatokat ne engedjen a szaunába!

Az elektromos részeket nem érheti víz! Ügyeljen rá, hogy a szaunakályhára ne fröcsögjön víz vagy veríték, mert ez rövidzárlatot okozhat.

A szaunakályhát soha ne takarja le, mert tűzveszélyes. Mindig tartsa távol a kályhától a gyúlékony anyagokat (pl. törölközőket). Ha tűz ütne ki a szaunában, megfékezésére soha ne használja ruháit vagy törölközőit.

Ne érintse meg a kályhát a használat során és röviddel utána, mivel a forró részek miatt fennáll az égési sérülések veszélye.

Ne nyúljon a forró villanykörtéhez!

Ha izzót kell cserélni, előtte áramtalanítsa a szaunát és várja meg, míg az izzó kihűl.

Az elektromos zárlatok elkerülése érdekében a szaunában ne használjon fém tárgyakat.

Amennyiben nem használja a készüléket, figyeljen rá, hogy mindig kapcsolja ki.

3 óránál hosszabb ideig ne hagyja bekapcsolva a szaunakályhát. 3 óra használat után legalább egy óra hosszára kapcsolja ki a készüléket.

Bekapcsolt állapotban ne hagyja felügyelet nélkül a készüléket!

Az áramütések elkerülése érdekében viharban ne használja a szaunát!

Ne szereljen zárat a szauna ajtajára, nehogy valaki a szaunában rekedjen!

A szauna jótékony élettani hatásai

- a forró és száraz levegőn elpusztulnak a baktériumok, vírusok
- a verejtékezéssel a bőrön keresztül távoznak a szervezetből a méreg- és salakanyagok
- javítja a vérkeringést, erősíti a szívet
- növeli a szervezet ellenálló képességét
- rugalmassá teszi a bőrt
- enyhíti az izomlázat
- stresszoldó hatása van
- alvászavarok ellen is hatásos

Szaunázás közben fokozódik a vérkeringés, ezáltal a szervezet több oxigénhez jut, így könnyebben ellazul, regenerálódik. Már havi egyszeri szaunázás is pozitív hatással bír.

MIKOR NE SZAUNÁZZON?

A szauna kiváló a betegségek kialakulásának megelőzésére, azonban ha már lázas beteg, akkor tilos szaunázni!

Ellenjavallt a szauna használata:

- idős, legyengült személyeknek
- krónikus betegségben (diabétesz, epilepszia) szenvedőknek
- várandós anyáknak
- 12 év alatti gyermekeknek
- túlsúlyos, szívbeteg, magas vérnyomással vagy keringési és visszérproblémákkal küzdő személyeknek
- ha Ön rosszul tűri a meleget

Soha ne használja a szaunát, ha gyógyszert vett be, alkoholt vagy kábítószerrel fogyasztott, mert ezek használata a szaunában eszméletvesztéshez vezethet.

Néhány jótanács

Ha a szauna használata előtt meleg vagy forró zuhanyt vesz, még intenzívebbé teheti a verejtékezést. Tusolás után alaposan törölközzön meg. Egyrészt a száraz bőr jobban verejtékezik, másrészt a víz károsítja a kabin faanyagát.

A szaunázáshoz minimum 3 törölközőt használjon. Egyet terítsen a padlóra, a lába alá, egyet a padra, amire ráül, a harmadikkal pedig rendszeresen itassa fel testéről az izzadságot.

Szaunázás előtt mindig vegye le az ékszereit, mert a nagy melegben azok gyorsan felforrósodnak és megégethetik bőrét.

Se éhesen, se tele gyomorral ne használja a szaunát. Szaunázás előtt csak mértékkel vegyen magához folyadékot, szaunázás után viszont fogyasszon legalább egy liter vizet.

Megerőltető fizikai igénybevétel (sport, munka) után ne használja a kabint. Várjon legalább 30 percet, amíg szervezete pihen. A szaunázás akkor a leghatásosabb, ha ruha nélkül teszi. A fürdőruhával betakart testfelület alatt a bőr nem tud lélegezni, így a méregtelenítő folyamatok nem működnek megfelelően.

A szaunázás javasolt időtartama: 8-12 (kezdőként 4-8) perc, amelyet kövessen egy 5-10 perces hűlési fázis hideg vízes zuhanyzással.

F30310

Instrucțiuni

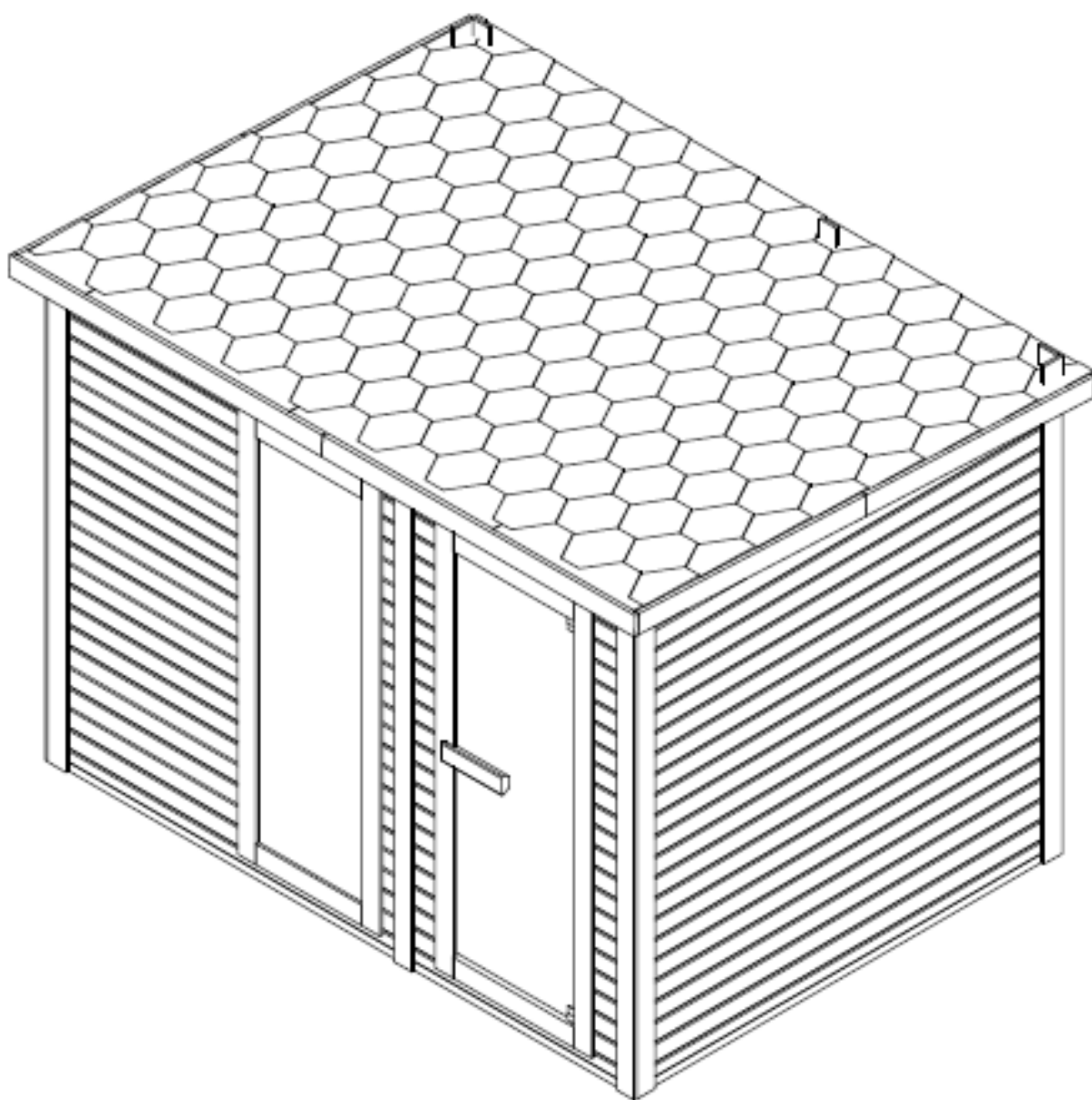

ATENȚIE

Citiți cu atenție acest ghid înainte de a utiliza sauna pentru prima dată.

Vă recomandăm să îl depozitați într-un loc sigur, astfel încât să îl puteți folosi din nou în viitor.

Vă rugăm să rețineți numărul de serie al cutiei de comandă a cabinei, deoarece acest număr este necesar în cazul unei comenzi de reparații sau piese de schimb.

- Lemnul este un element viu. Pentru a-și menține aspectul original, este important să tratați exteriorul lemnului împotriva umezelii.
- Așezați sauna pe o suprafață perfect plană și dură.
- Nu folosiți detergenți lichizi. Opriți sauna înainte de curățare și folosiți anunțamp pânză.
- Protejați cablul de alimentare al saunei, astfel încât să nu fie strivit sau ciupit.
- Înainte de a înlocui anumite componente, asigurați-vă că acestea sunt prescrise de producător sau au aceleași caracteristici ca și piesele originale. Înlocuirea incorectă poate provoca un incendiu, scurtcircuit sau deteriorarea saunei. Vă recomandăm insistent să apelați la un tehnician calificat.
- Pentru a evita riscul de arsuri sau electrocutări, nu utilizați unelte metalice.
- Animalele nu sunt permise în saună.
- Nu lăsați sauna nesupravegheată.
- Nu lăsați sauna pornită mai mult de 1 oră la un moment dat pentru a evita deteriorarea prematură a dispozitivului. Opriți sauna timp de cel puțin 30 de minute după 1 oră de utilizare continuă.
- Se recomandă să nu instalați un sistem de blocare pe ușa saunei.
- Înainte de a conecta sauna la rețea, verificați dacă instalația electrică îndeplinește cerințele.
- Instalarea și reparațiile pot fi efectuate numai de un electrician calificat!
- Utilizați numai piese originale.
- Opriți sauna când nu este utilizată.

PERICOL

- Acoperirea sobelor duce la un risc de incendiu din cauza supraîncălzirii. Nu acoperiți elementele de încălzire!
- Păstrați întotdeauna materialele/obiectele inflamabile sau foarte inflamabile (de exemplu, prosoape) departe de încălzitorul de saună.
- Nu atingeți încălzitorul în timpul și la scurt timp după utilizare, deoarece există riscul de arsuri din partea părților fierbinți.
- Becul se încălzește în timpul funcționării. Dacă becul trebuie schimbat, deconectați-l de la cabină și lăsați-l să se răcească
- se răcește înainte de a le înlocui.

Siguranță

IMPORTANT!

Vă rugăm să citiți cu atenție instrucțiunile de siguranță înainte de a vă instala și utiliza cabina de saună.
Notificările sunt importante pentru siguranța dumneavoastră, așa că vă rugăm să le respectați cu strictețe.

Atenție la hipertermie, insolație sau epuizare termică, care poate fi cauzată sau exacerbată de nerespectarea instrucțiunilor de siguranță. Simptomele includ febră, puls rapid, amețeli, leșin, letargie și amorțeală în tot corpul sau în părți ale corpului. Efectele sunt: percepția redusă a căldurii, ignoranța pericolelor iminente, pierderea cunoștinței.

Sauna nu poate fi folosită de:

- Copii sub 6 ani.
- Persoane cu reacții puternice la lumina soarelui.
- Persoane cu afecțiuni preexistente, cum ar fi boli de inimă, hipertensiune arterială sau scăzută, tulburări circulatorii sau diabet fără sfatul medicului prealabil.
- Femei însărcinate. Temperatura excesivă poate pune în pericol fătul.
- Persoane care suferă de deshidratare, răni deschise, boli oculare, arsuri sau insolație.

Copiii cu vârste cuprinse între 6 și 16 ani au voie să folosească sauna, cu condiția să fie supravegheați constant de un adult responsabil și temperatura să nu depășească 60°C.

În caz de probleme de sănătate, medicamente sau leziuni ale mușchilor și ligamentelor, puteți folosi sauna numai după consultarea prealabilă a unui medic și aprobarea acestuia.

Dacă aveți implanturi chirurgicale, nu trebuie să folosiți sauna fără a consulta mai întâi un medic și a obține consimțământul acestuia. Nu folosiți sauna după activități intense.

Așteptați 30 de minute pentru ca corpul să se răcească.

Nu petreceți mai mult de 40 de minute la un moment dat în saună.

Nu consumați alcool sau droguri înainte sau în timpul sesiunii.

Nu dormiți în saună când este în funcțiune.

Pentru a evita riscul de supraîncălzire, conectați sauna la o priză suficient de puternică și nu conectați alte aparate electrice la aceeași priză.

Pentru a evita riscul de electrocutare sau deteriorarea saunei, aceasta nu trebuie utilizată:

- În timpul unei furtuni.
- Dacă cablul electric este deteriorat, acesta trebuie înlocuit de o persoană calificată.
- Dacă cablul de alimentare se supraîncălzește, acesta trebuie verificat de o persoană calificată.
- Dacă trebuie să schimbați un bec, așteptați ca sauna să se oprească și să se răcească.

Uscați-vă mâinile înainte de a conecta sau opri alimentarea.

Nu lucrați niciodată cu mâinile sau picioarele ude.

Nu porniți sau opriți rapid alimentarea sau încălzirea, deoarece acest lucru ar putea deteriora sistemul electric.

Nu încercați să reparați singur sauna fără acordul dealerului de saună sau al producătorului.

Încercările neautorizate de reparații vor anula garanția producătorului.

Nu folosiți detergenți în saună.

Nu stivuiți și nu depozitați obiecte în saună.

Nu așezați materiale inflamabile sau substanțe chimice în apropierea saunei.

Nu acoperiți elementele de încălzire!





Nu atingeți încălzitorul în timpul și la scurt timp după utilizare, deoarece există riscul de arsuri din cauza părților fierbinți.



Opriti cabina atunci când nu este utilizată.

Specificatii:

Model	F30310
Materialul cabinei	Molid
Adâncime	2300 mm
Lățime	3100mm
Înălțime	2200 mm
Voltaj	AC380V
Încălzitor	8KW

Componente (Sunt posibile abateri)

											
Ø3x16	Ø4x70	Ø4x60	Ø4x50	Ø4*40	Ø4*30	Ø4*18	Ø5*100	Ø6x60	Wood pad		
6x	103x	300x	76x	240x	62x	40x	2x	4x	2x	2x	4x

		
2x	10x	2x

Vă rugăm să scoateți ambalajul de transport și să verificați dacă cabina cu infraroșu a fost livrată completă și intactă înainte de a începe asamblarea.

Citiți cu atenție instrucțiunile de asamblare înainte de a găsi un loc potrivit pentru sauna dvs.

Sauna este concepută exclusiv pentru instalarea în aer liber.

Selectați o zonă:

- Într-un loc uscat, pe o suprafață plană și stabilă, care poate susține greutatea saunei tale.
- Înălțimea trebuie să fie suficientă pentru a putea ajunge la tavan și a efectua conexiuni electrice și întreținere.
- A se păstra departe de surse de apă, flăcări sau materiale inflamabile.
- Înălțimea minimă necesară a camerei este de 2,02 m

Sfaturi practice

- Vă rugăm să rețineți că sunt necesari cel puțin 2 adulți pentru a instala sauna.
- Identificați în mod unic fiecare panou înainte de a începe
- La instalare, așezați cablul de alimentare al saunei astfel încât să fie ușor accesibil.
- Rețineți că există diferențe între modele.

IMPORTANT:



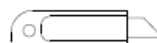
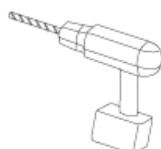
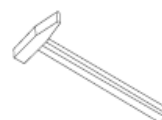
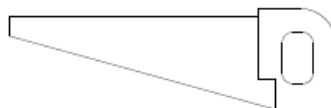
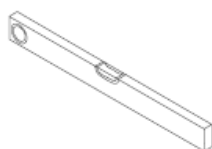

Vă rugăm să verificați diametrul orificiului pentru a evita deteriorarea lemnului.



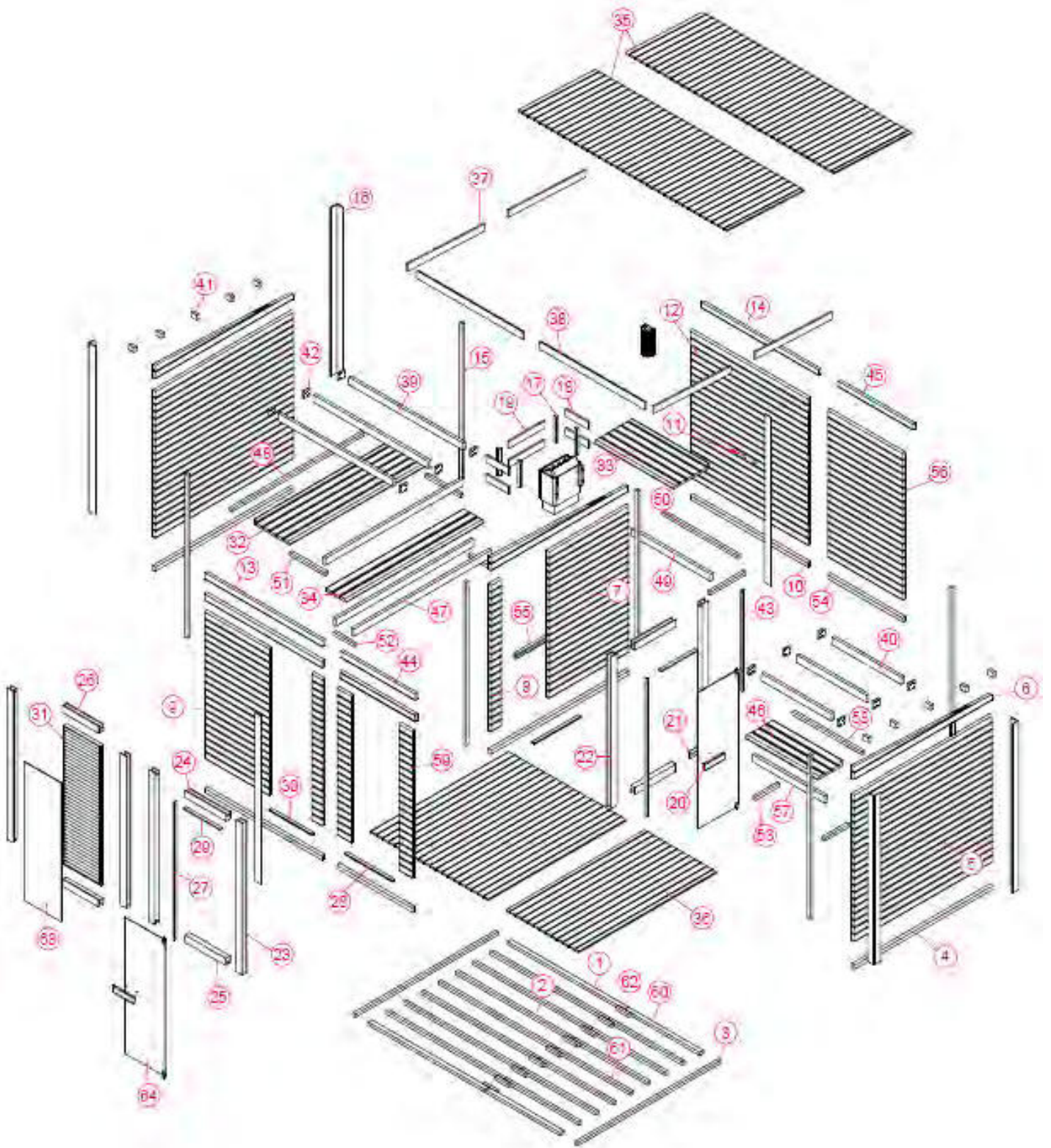

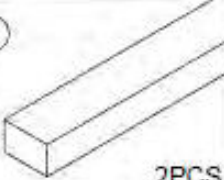
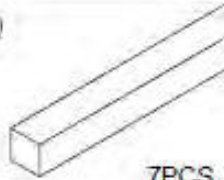
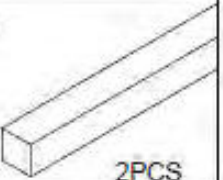

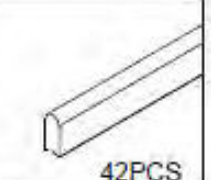
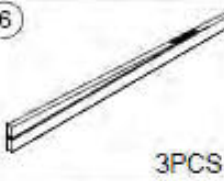
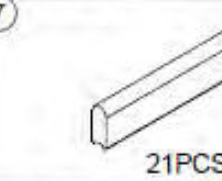
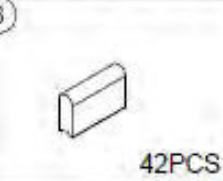
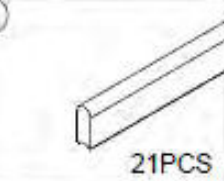
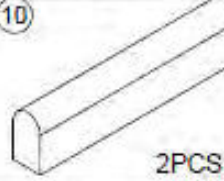
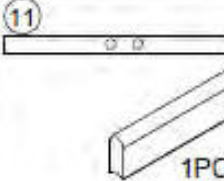
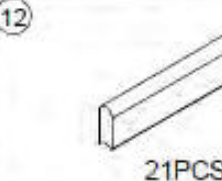
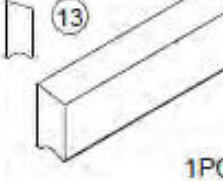
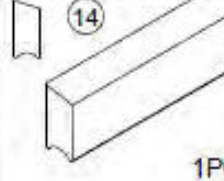
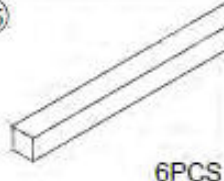
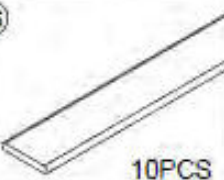
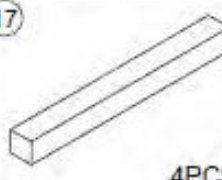
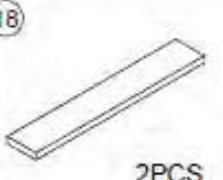
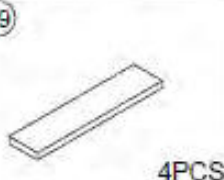
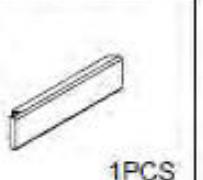
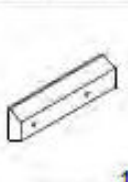
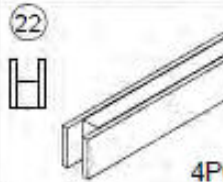
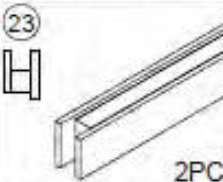
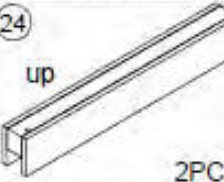
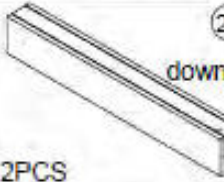
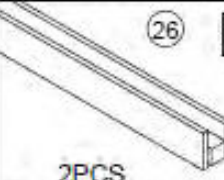
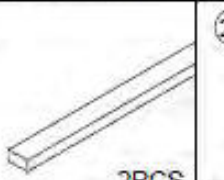
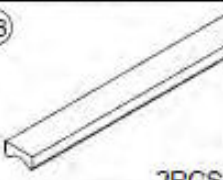
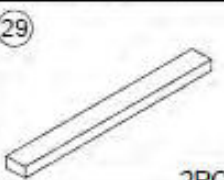
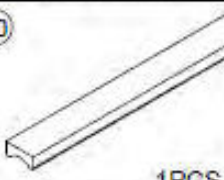

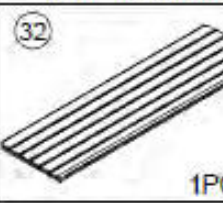
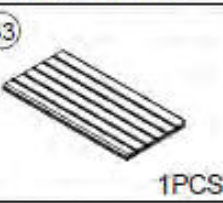
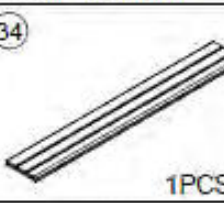
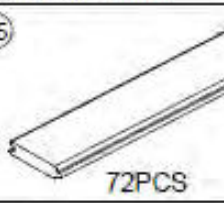
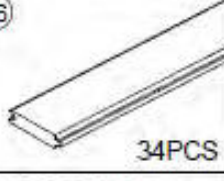
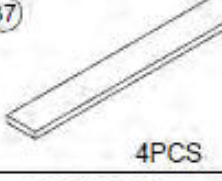
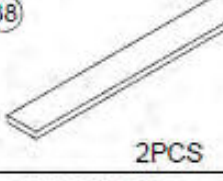
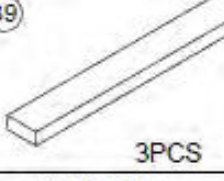
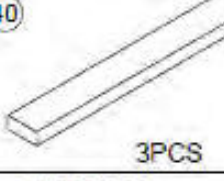

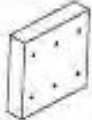
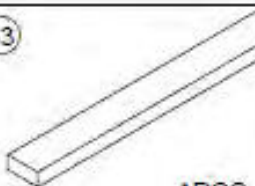
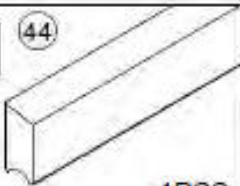
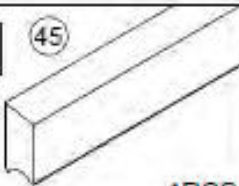
Instrumente:

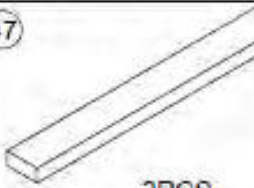
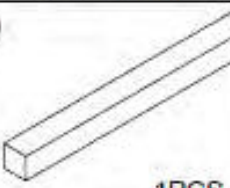
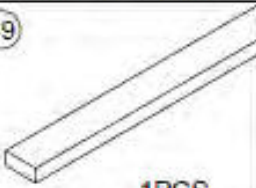
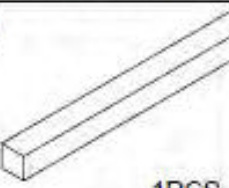
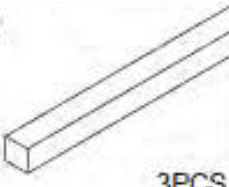
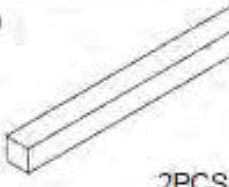
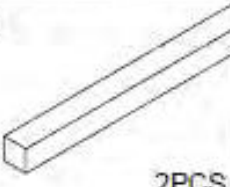

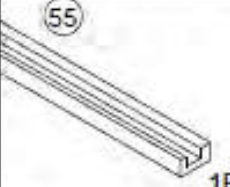
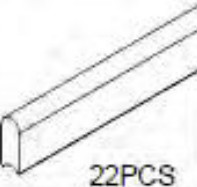
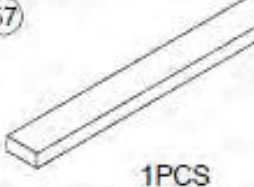
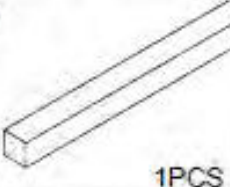
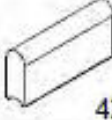
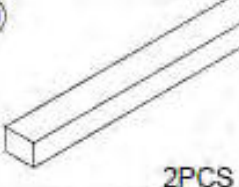
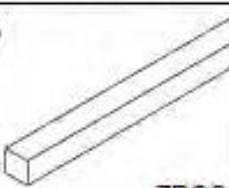
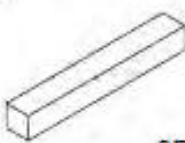
Lista de materiale:

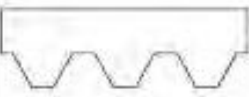

①  2PCS 1724*55*38mm	②  7PCS 1724*38*38mm	③  2PCS 2100*38*38mm	④  3PCS 2024*67*38mm	⑤  42PCS 2024*97*38mm
⑥  3PCS 2024*168*38mm	⑦  21PCS 1172*97*38mm	⑧  42PCS 150*97*38mm	⑨  21PCS 945*97*38mm	⑩  2PCS 1724*67*38mm
⑪  1PCS 1724*97*38mm	⑫  21PCS 1724*97*38mm	⑬  1PCS 1724*81*38mm	⑭  1PCS 1724*70*38mm	⑮  6PCS 2188*38*38mm
⑯  10PCS 2140*90*13mm	⑰  4PCS 330*33*33mm	⑱  2PCS 520*90*20mm	⑲  4PCS 340*90*20mm	⑳  1PCS 300*90*40mm
㉑  1PCS 252*90*40mm	㉒  4PCS 1927*90*66mm	㉓  2PCS 1927*90*66mm	㉔  2PCS 600*90*66mm	㉕  2PCS 600*90*66mm
㉖  2PCS 547*90*66mm	㉗  2PCS 1747*40*13mm	㉘  2PCS 700*38*17mm	㉙  2PCS 537*40*13mm	㉚  1PCS 627*38*17mm
㉛  1PCS 1765*545*47mm	㉜  1PCS 2022*560*33mm	㉝  1PCS 1162*560*33mm	㉞  1PCS 2022*300*33mm	㉟  72PCS 1130*97*18mm
㊱  34PCS 2022*97*18mm	㊲  4PCS 1132*90*20mm	㊳  2PCS 1552*90*20mm	㊴  3PCS 1684*90*38mm	㊵  3PCS 1022*90*38mm

<p>(41)</p>  <p>10PCS</p> <p>80*60*38mm</p>	<p>(42)</p>  <p>12PCS</p> <p>90*90*20mm</p>	<p>(43)</p>  <p>1PCS</p> <p>1550*33*13mm</p>	<p>(44)</p>  <p>1PCS</p> <p>1100*81*38mm</p>	<p>(45)</p>  <p>1PCS</p> <p>1100*70*38mm</p>
<p>(46)</p>  <p>1PCS</p> <p>1060*400*33mm</p>	<p>(47)</p>  <p>3PCS</p> <p>2022*90*38mm</p>	<p>(48)</p>  <p>1PCS</p> <p>1946*38*38mm</p>	<p>(49)</p>  <p>1PCS</p> <p>1162*90*38mm</p>	<p>(50)</p>  <p>1PCS</p> <p>1124*38*38mm</p>
<p>(51)</p>  <p>3PCS</p> <p>522*38*38mm</p>	<p>(52)</p>  <p>2PCS</p> <p>300*38*38mm</p>	<p>(53)</p>  <p>2PCS</p> <p>362*38*38mm</p>	<p>(54)</p>  <p>2PCS</p> <p>1100*67*38mm</p>	<p>(55)</p>  <p>1PCS</p> <p>820*40*20mm</p>
<p>(56)</p>  <p>22PCS</p> <p>1100*97*38mm</p>	<p>(57)</p>  <p>1PCS</p> <p>1060*90*38mm</p>	<p>(58)</p>  <p>1PCS</p> <p>1022*38*38mm</p>	<p>(59)</p>  <p>42PCS</p> <p>198*97*38mm</p>	<p>(60)</p>  <p>2PCS</p> <p>1100*55*38mm</p>
<p>(61)</p>  <p>7PCS</p> <p>1100*38*38mm</p>	<p>(62)</p>  <p>9PCS</p> <p>200*38*38mm</p>	<p>(63)</p>  <p>1PCS</p> <p>1764*544*6mm</p>	<p>(64)</p>  <p>1PCS</p> <p>1733*594*6mm</p>	<p>(65)</p>  <p>1PCS</p> <p>300*142*105MM</p>
 <p>Sauna light</p>	 <p>Sauna stove</p>	 <p>69PCS</p> <p>1000*320*5mm</p>		

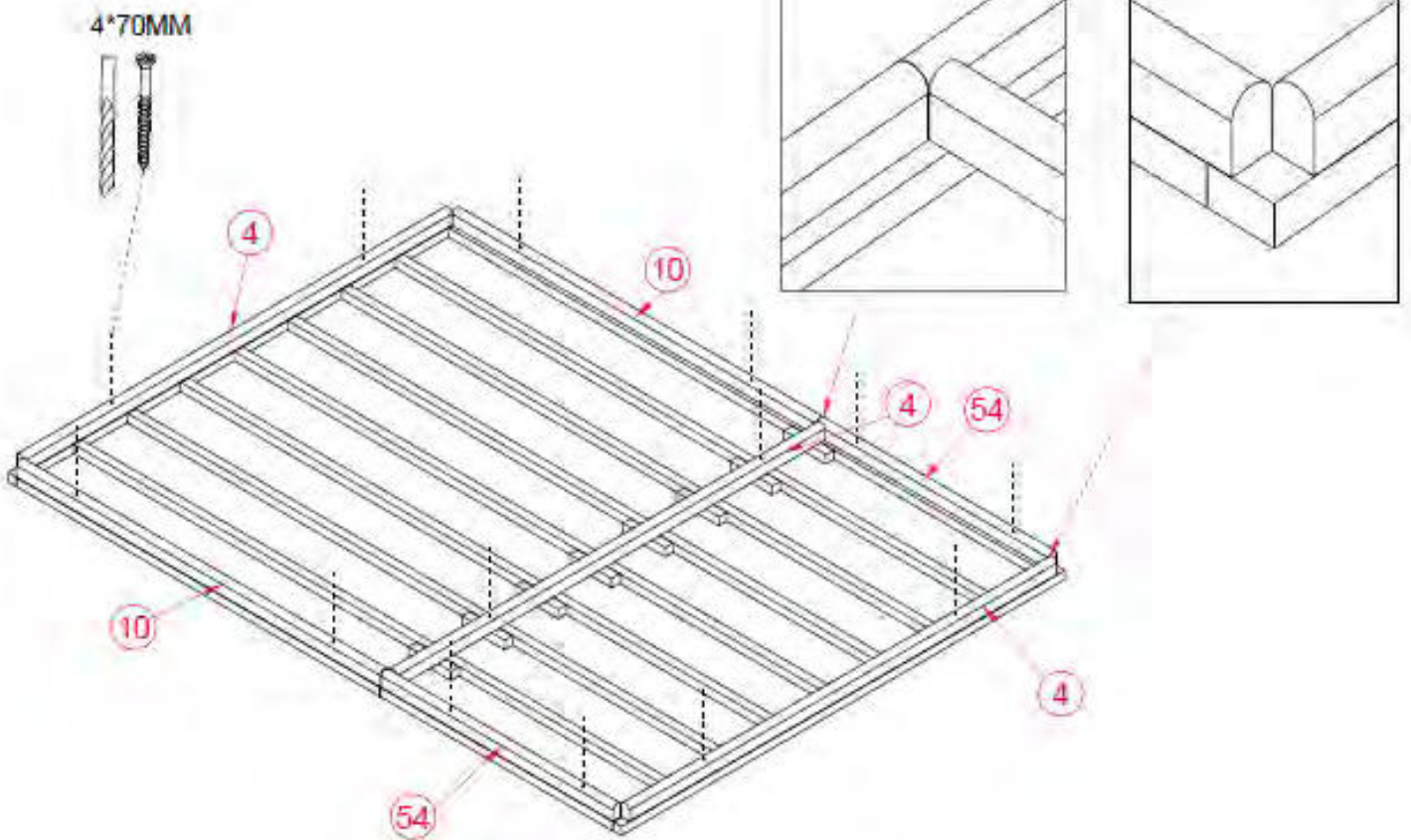
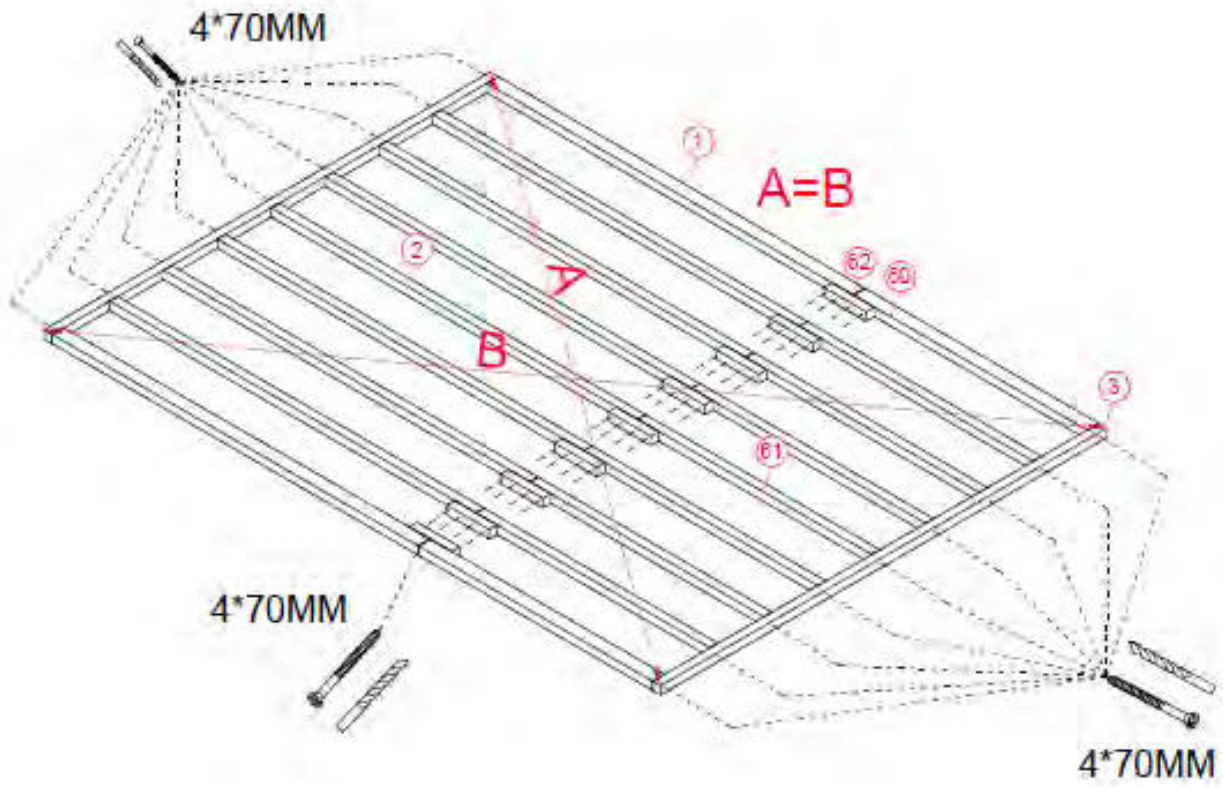

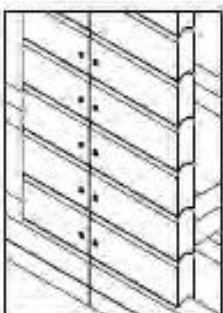
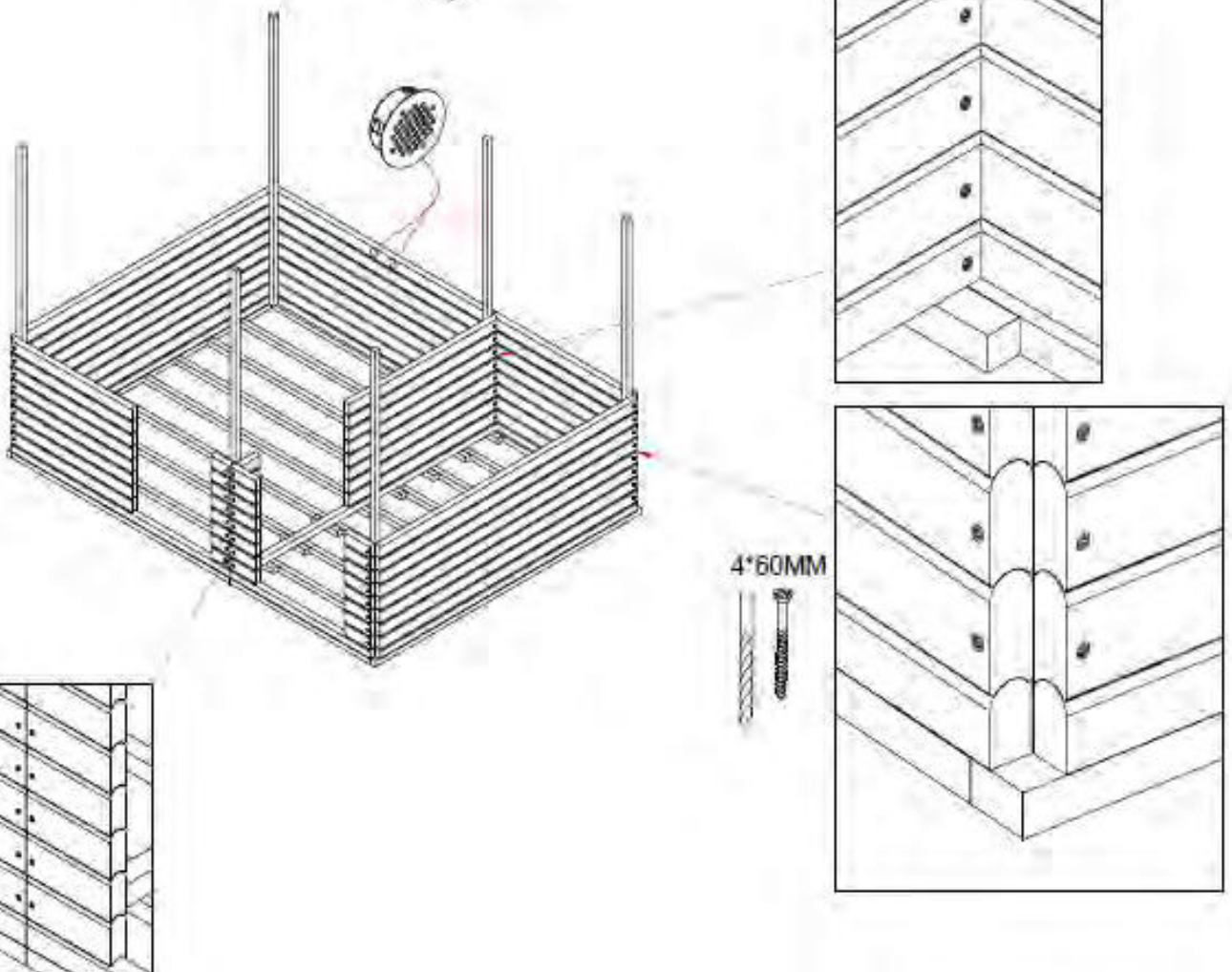
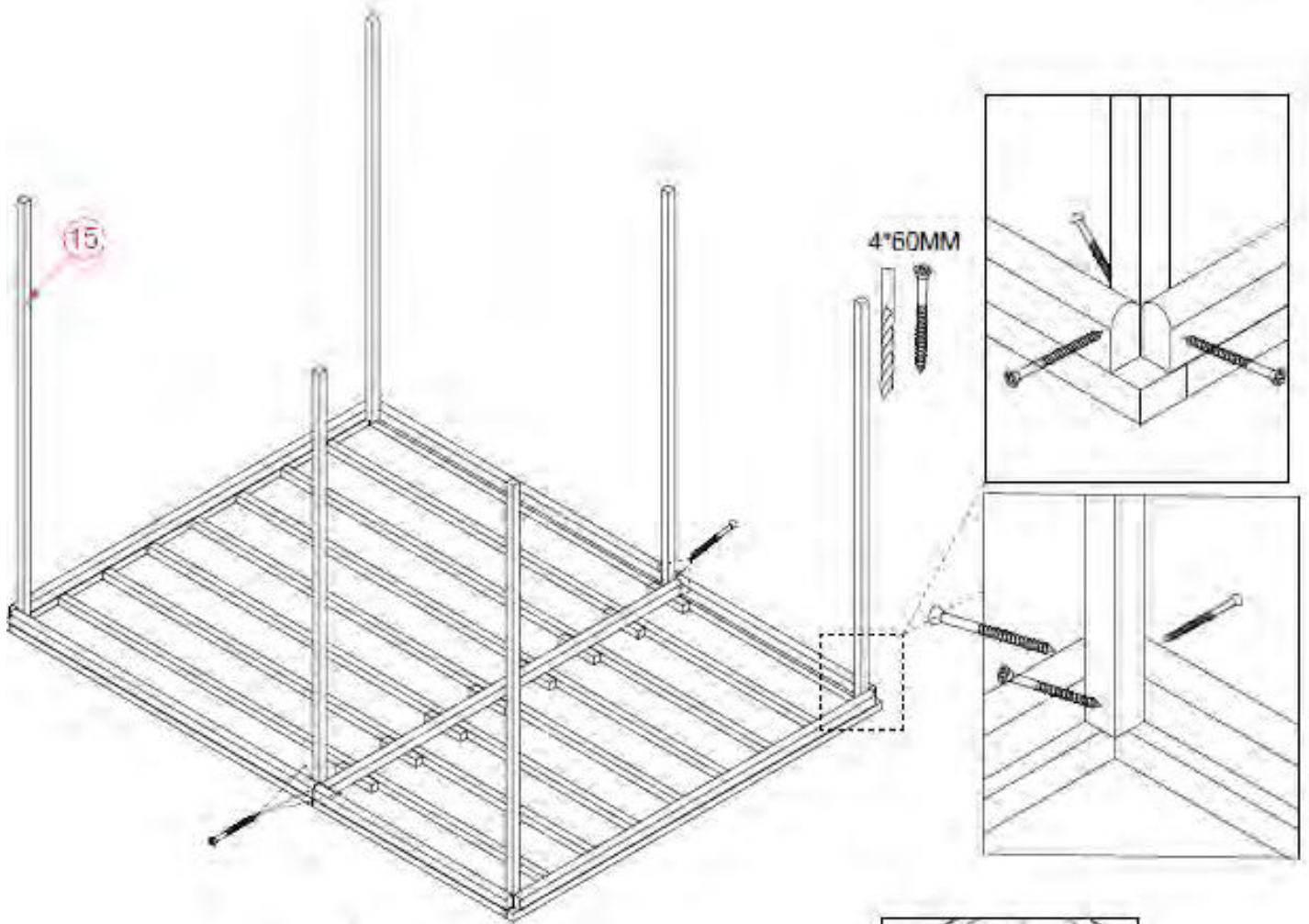

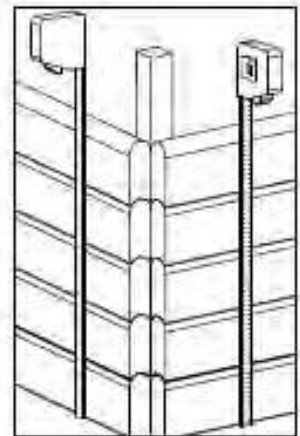
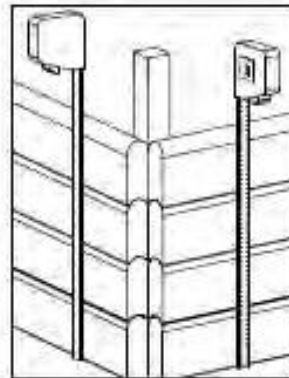
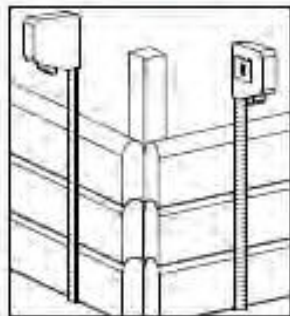
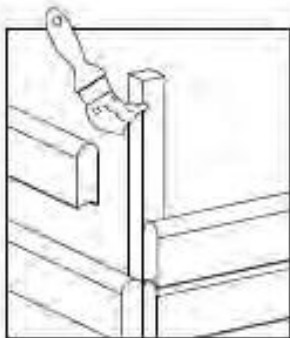
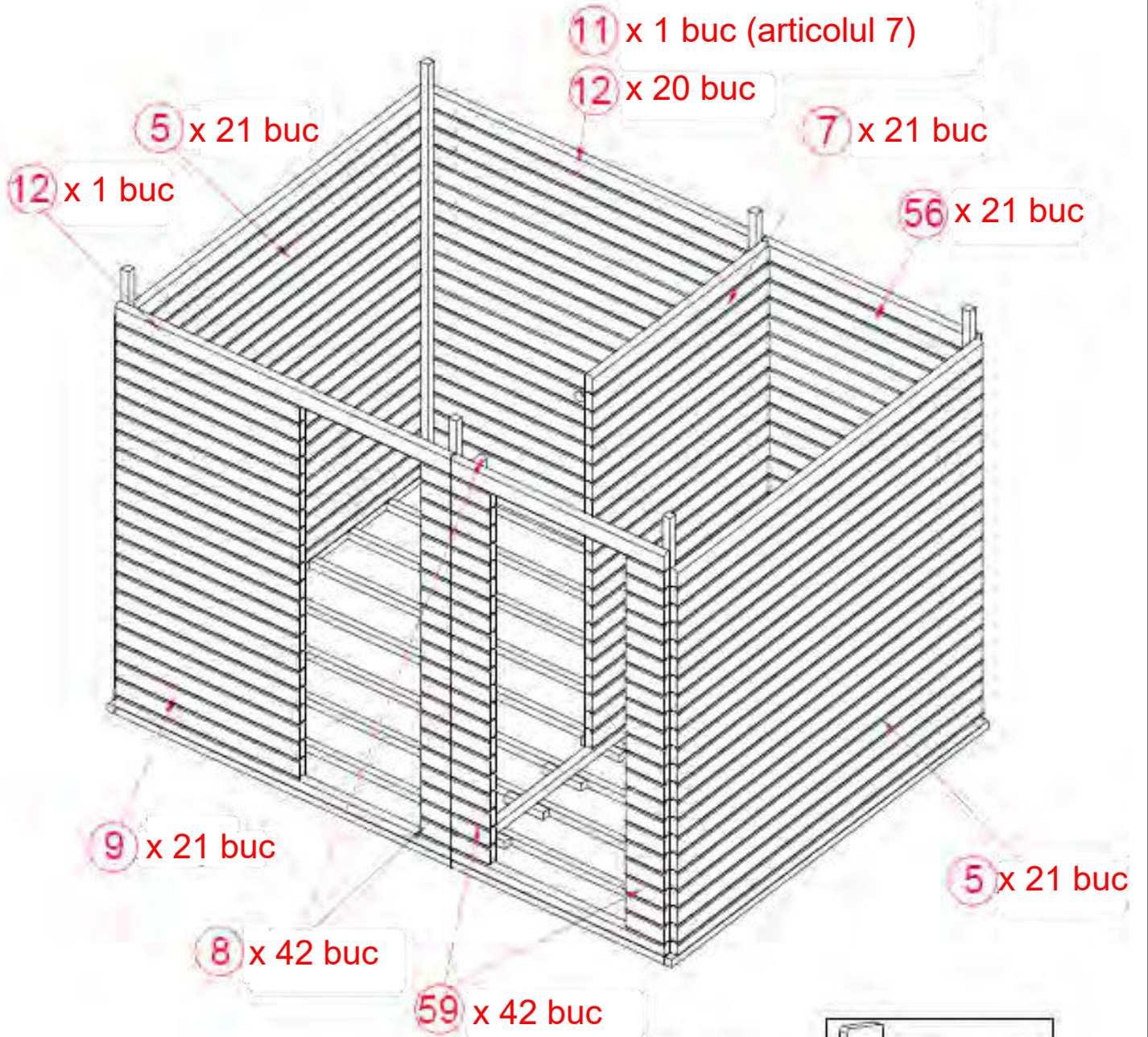

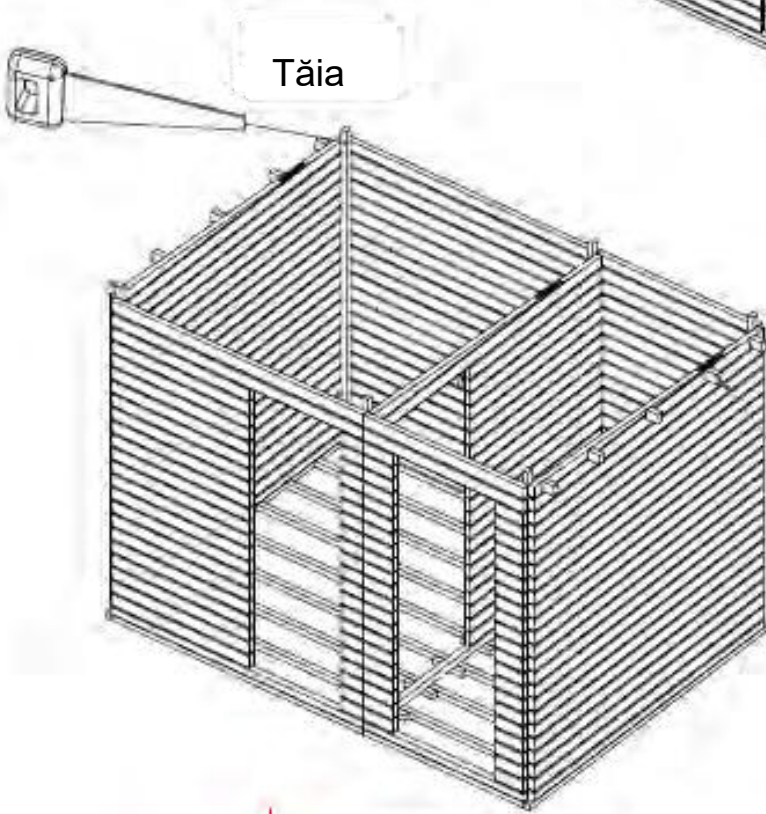
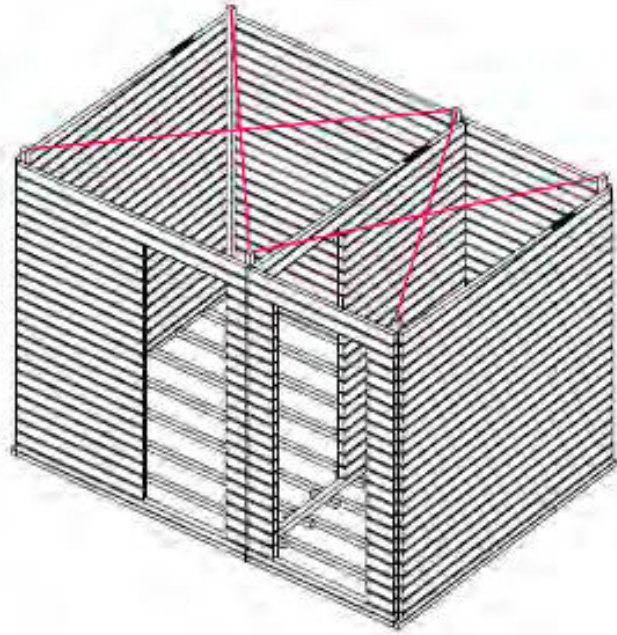

41 x 10 buc

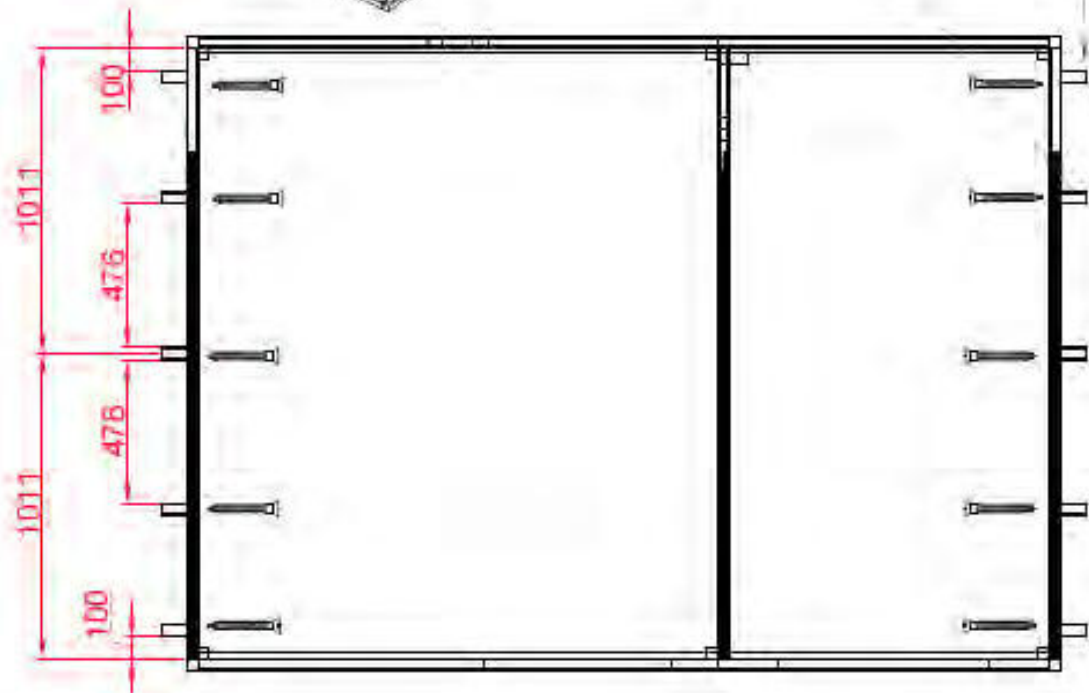

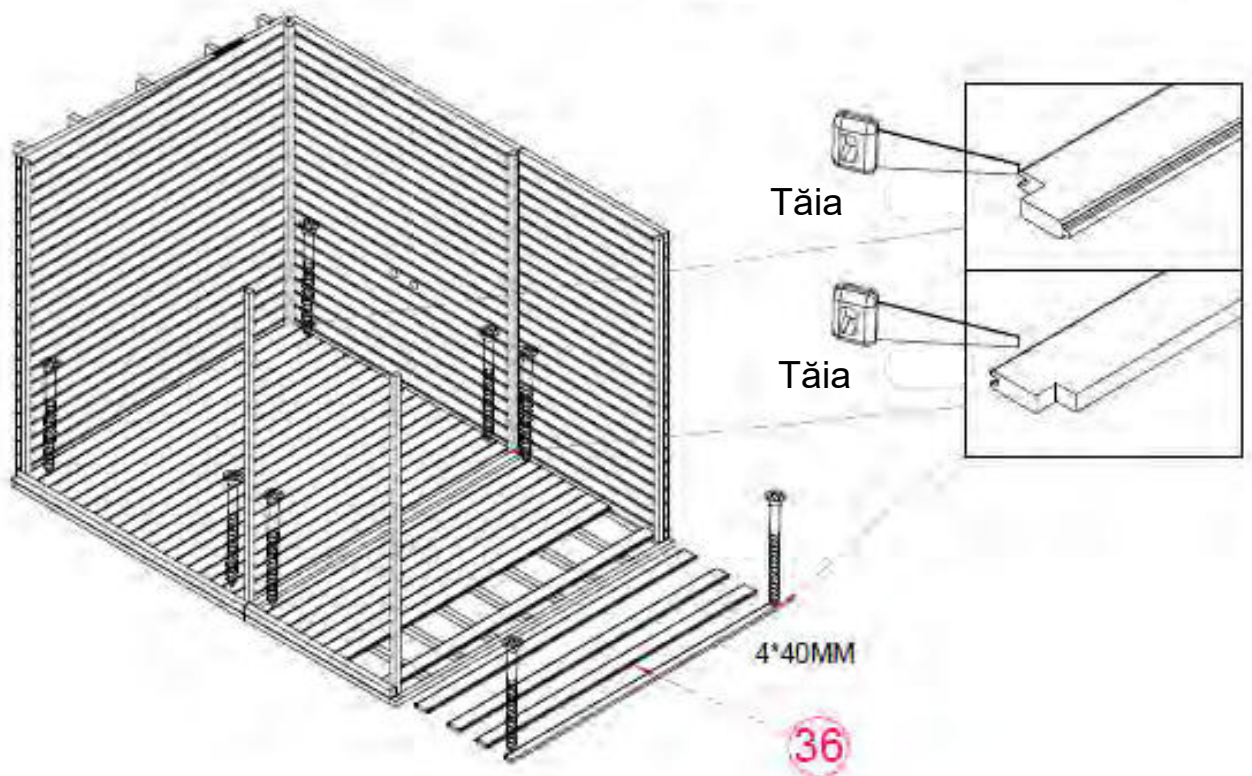
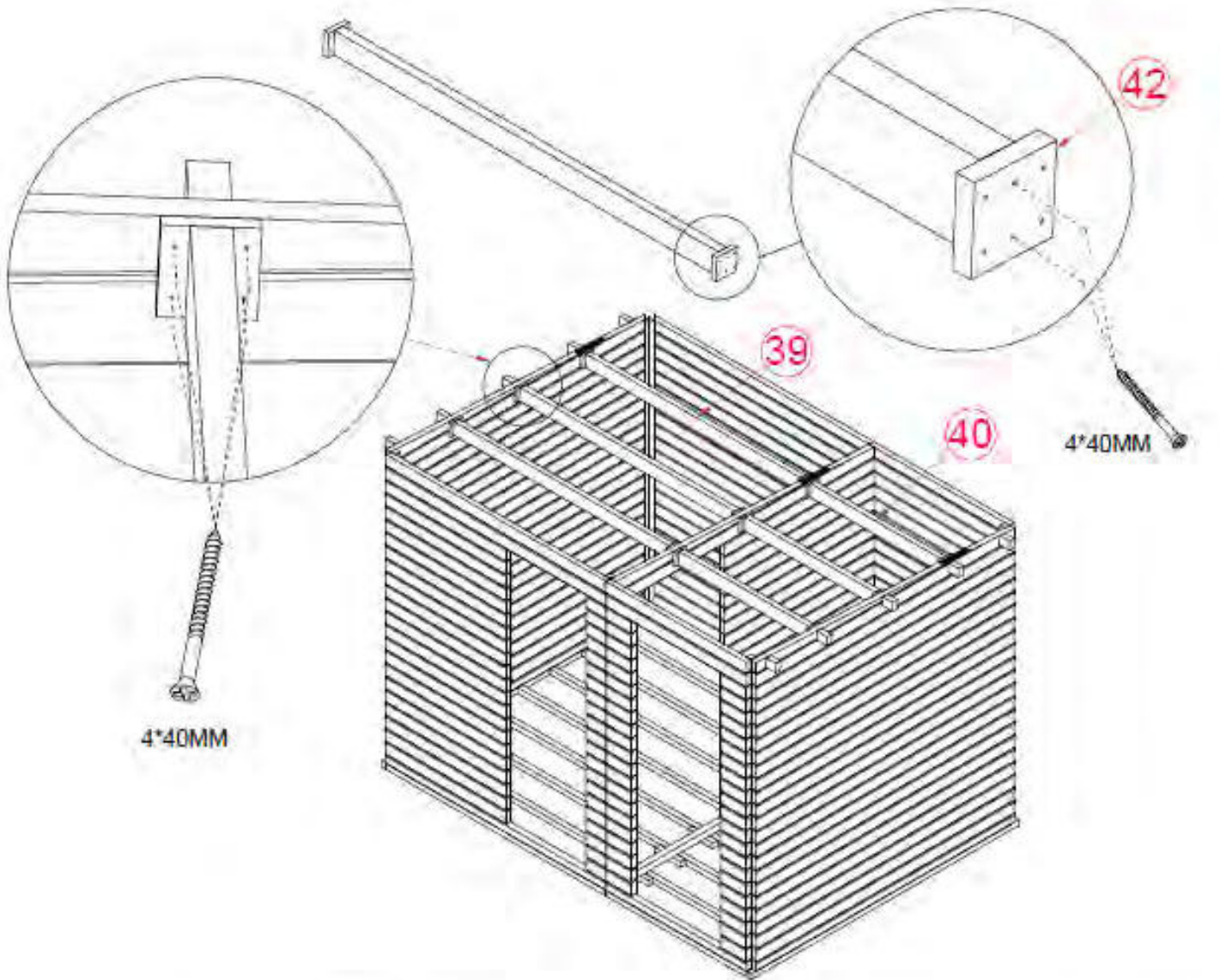

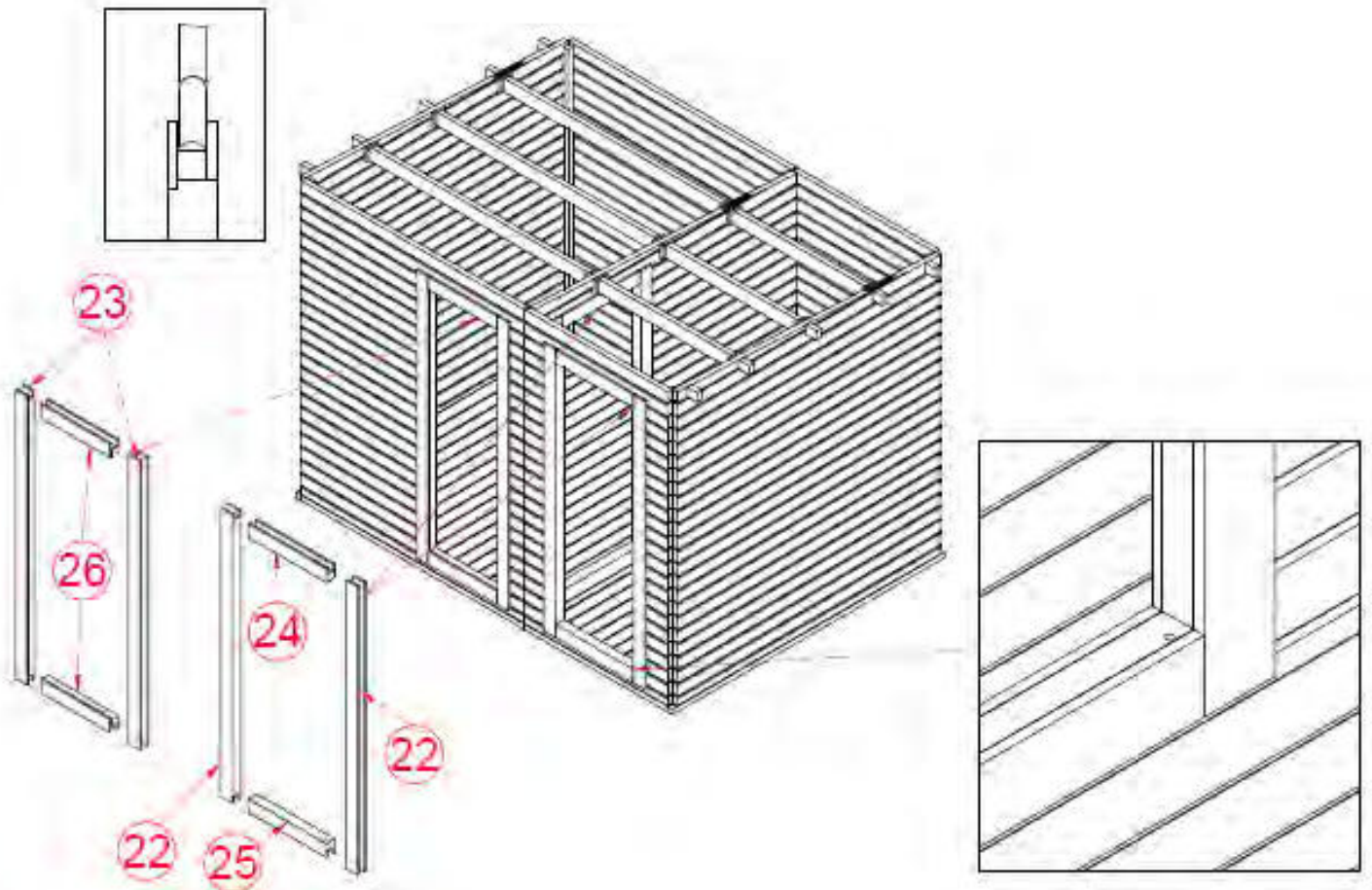
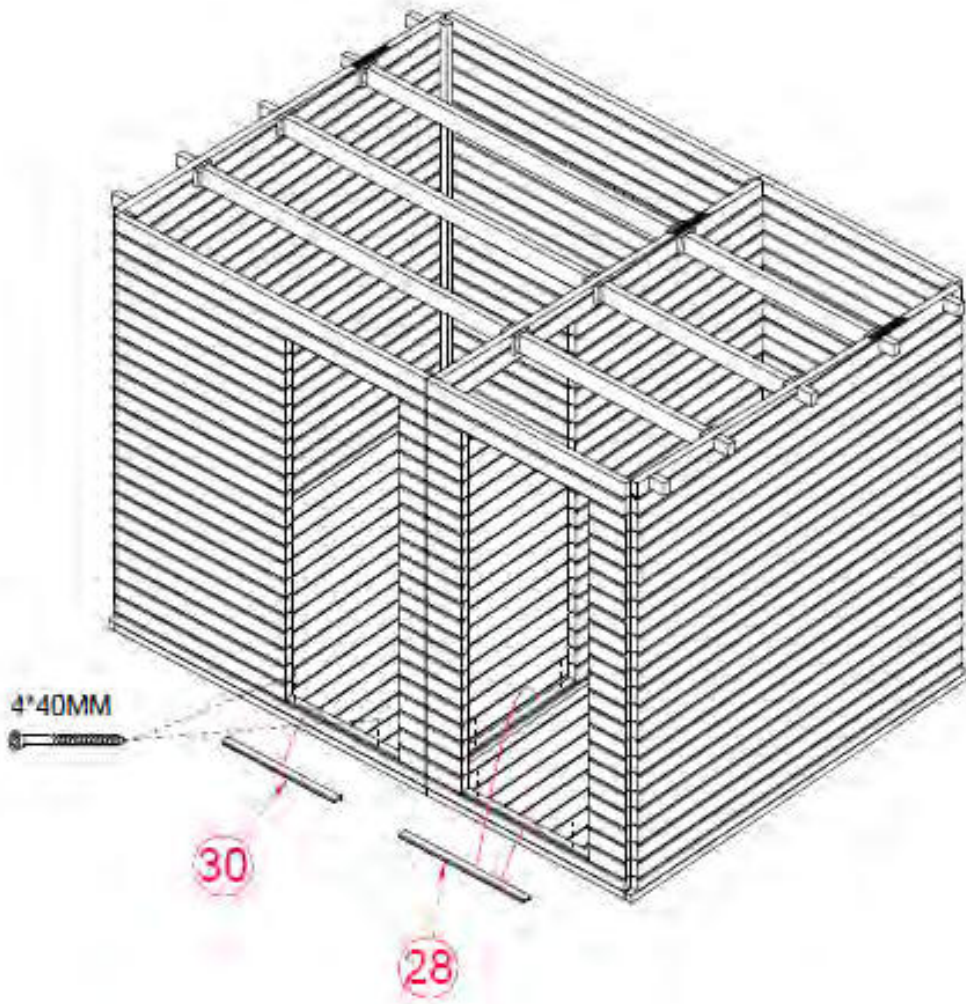

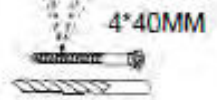
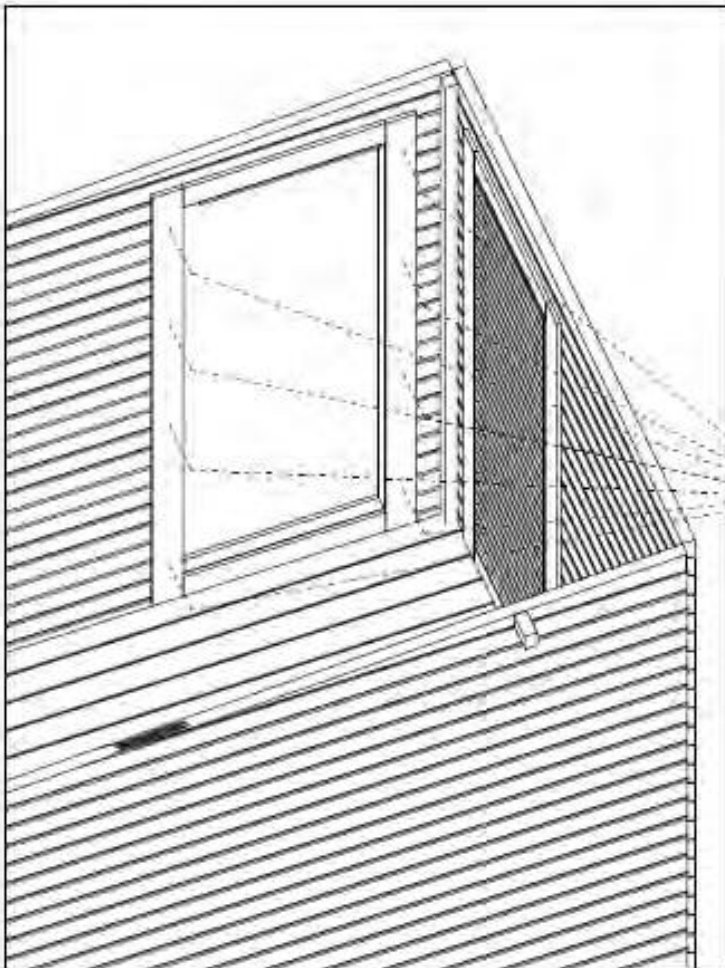
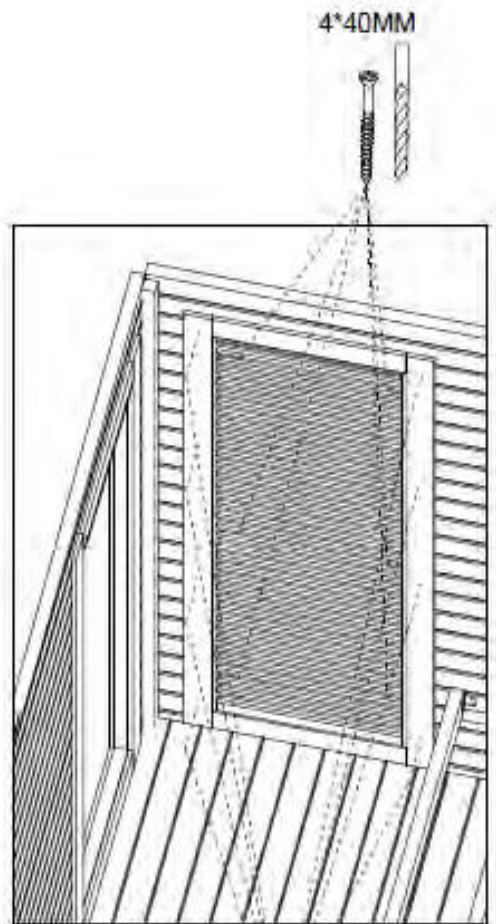
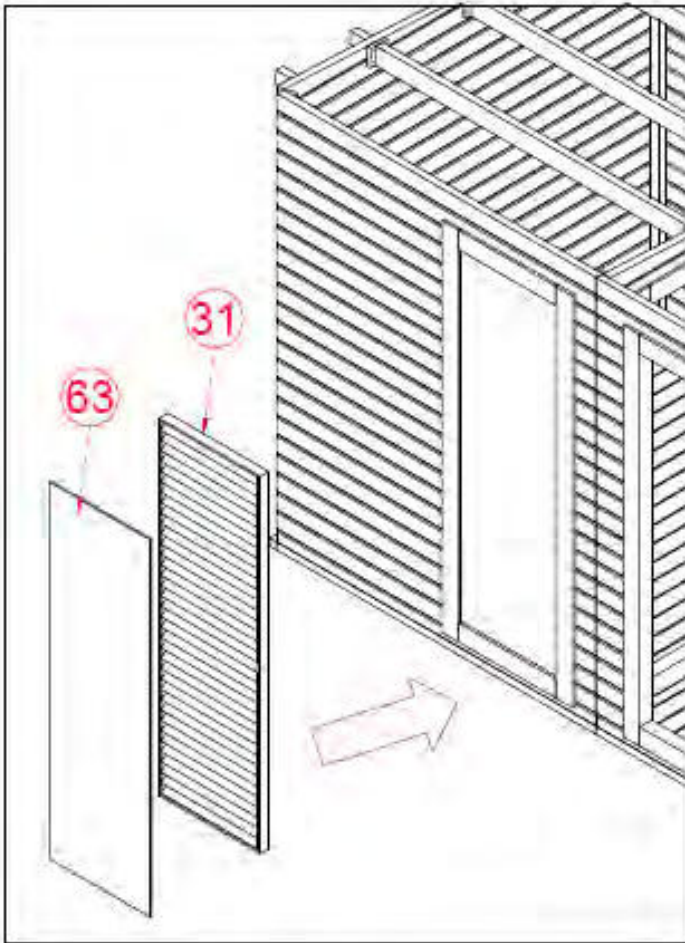

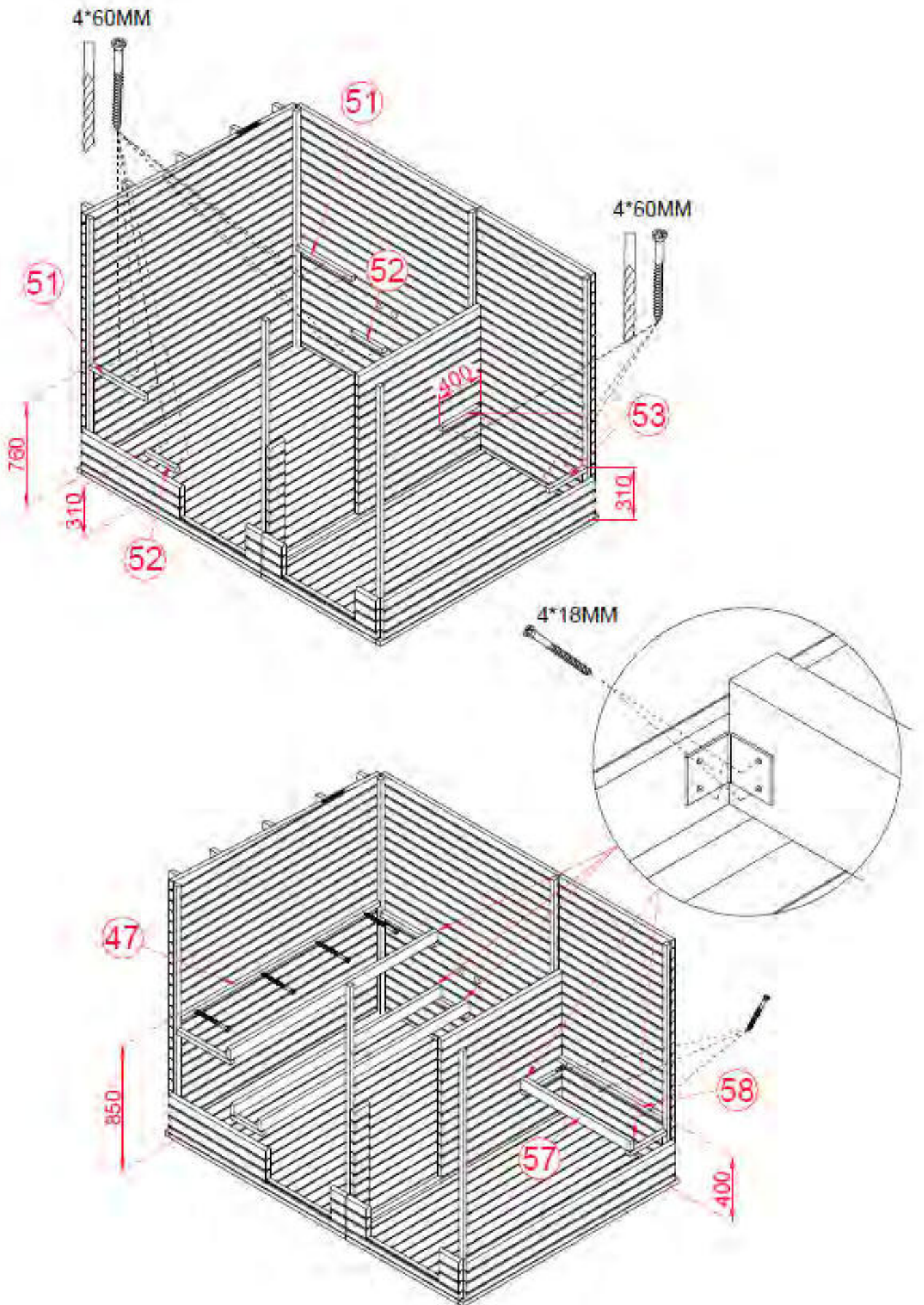

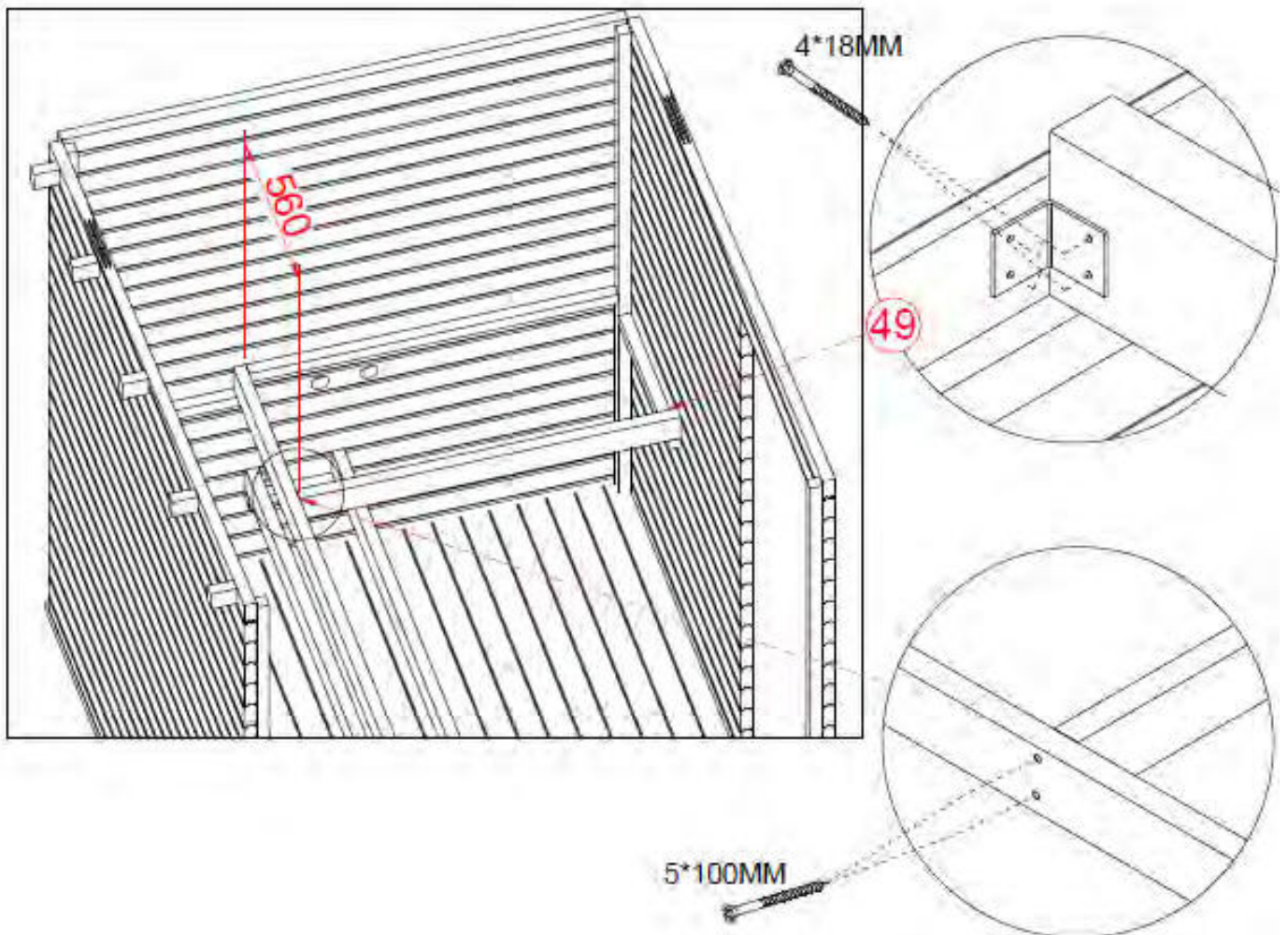
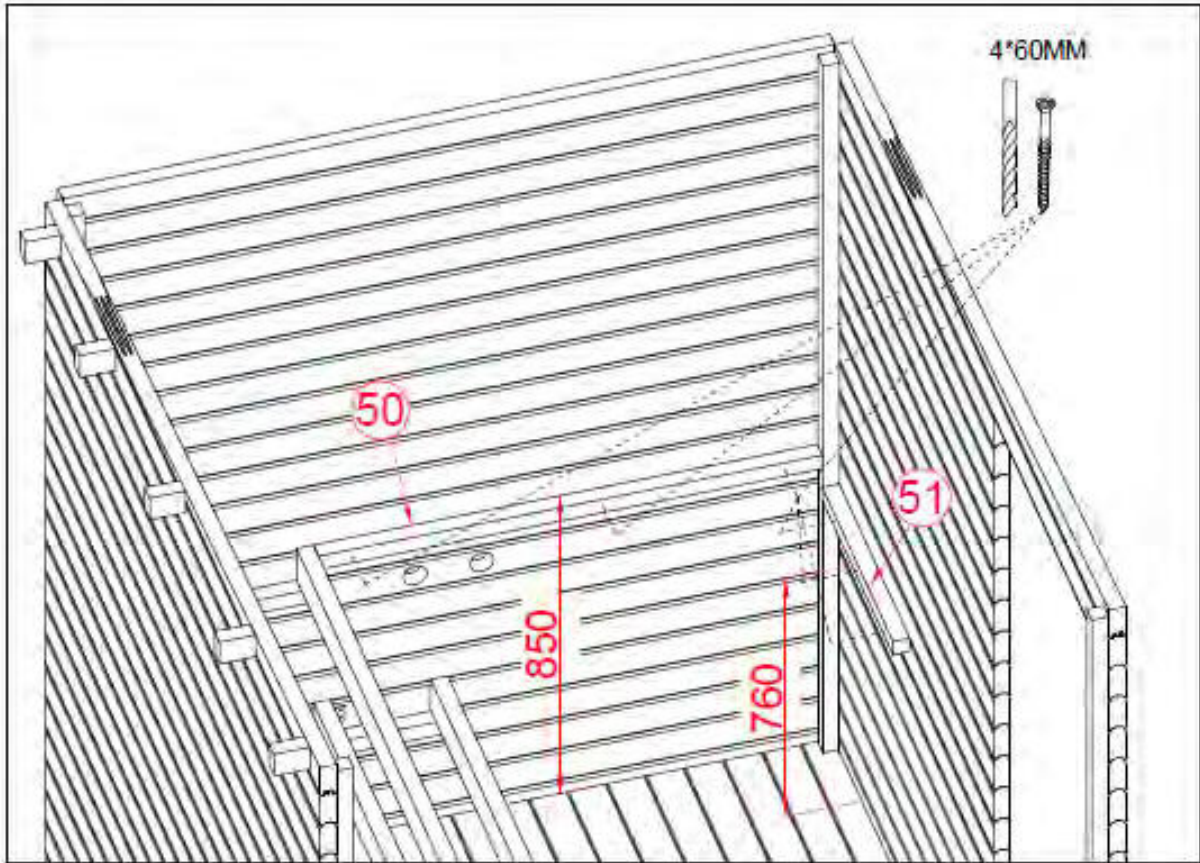

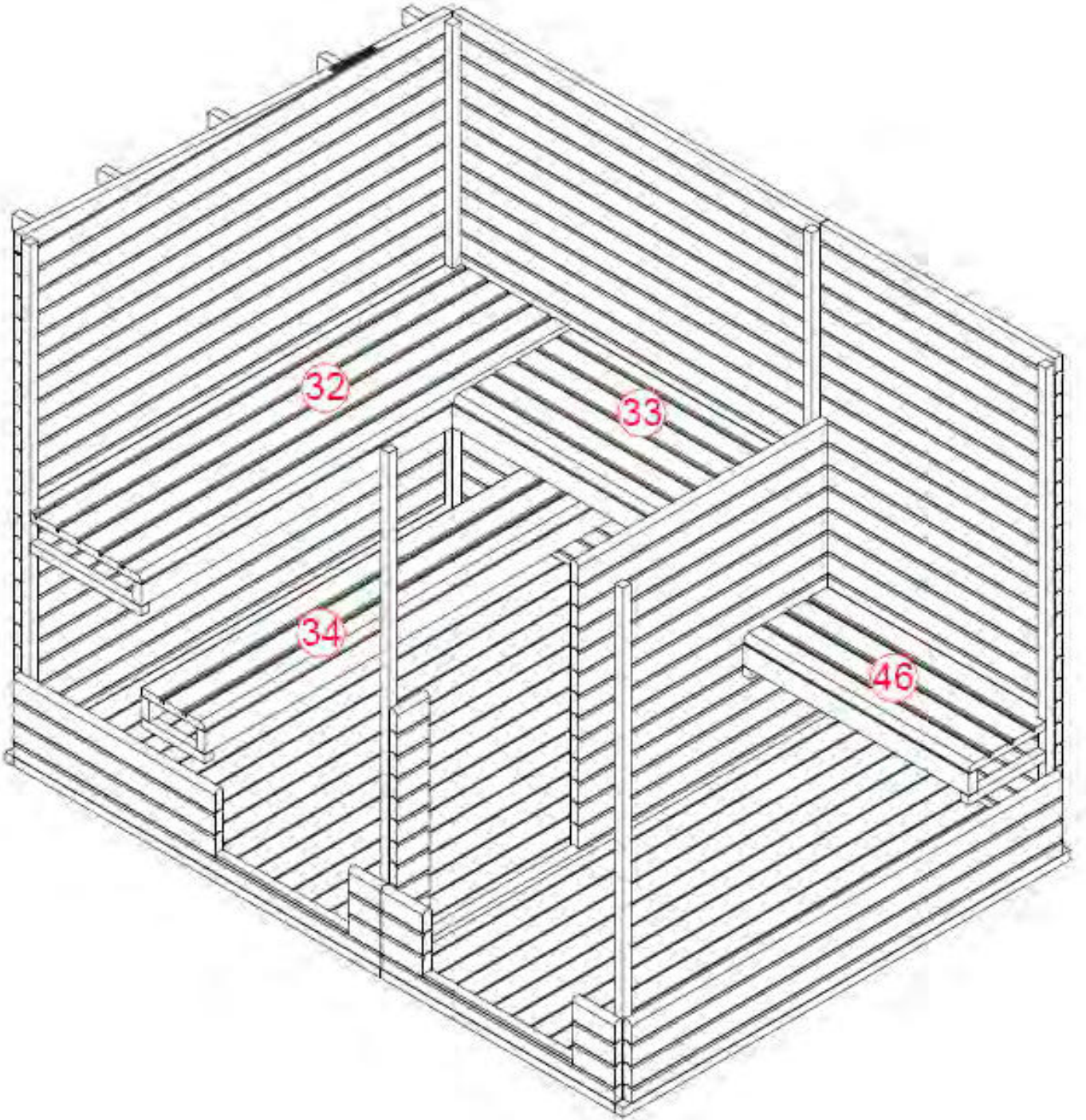

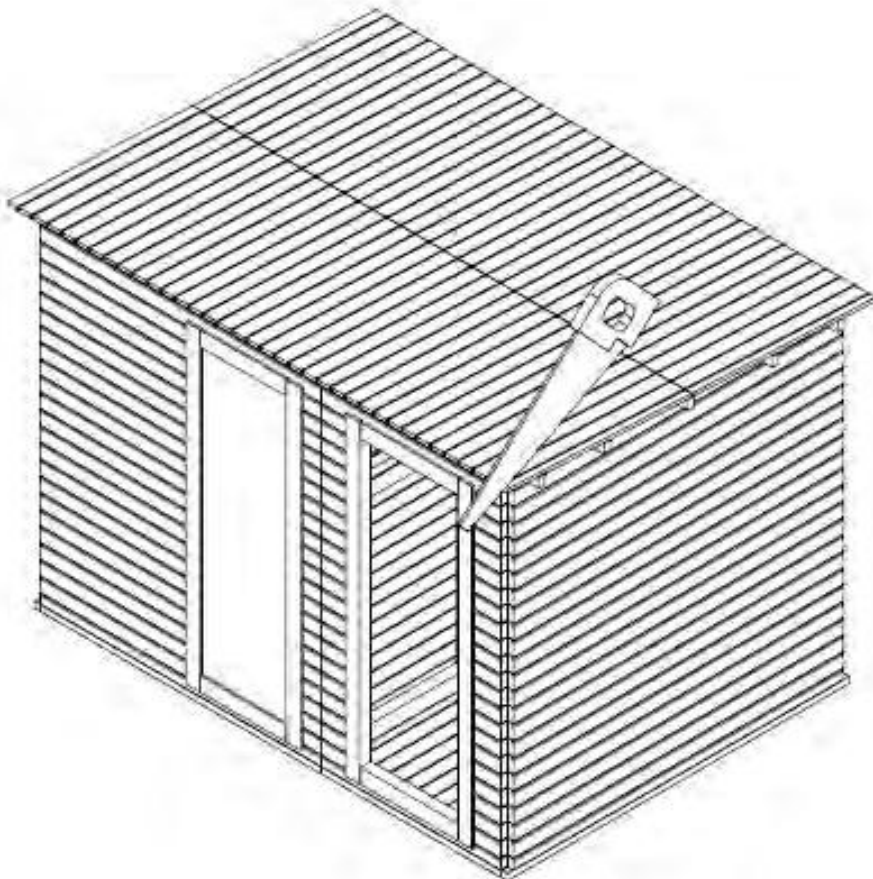
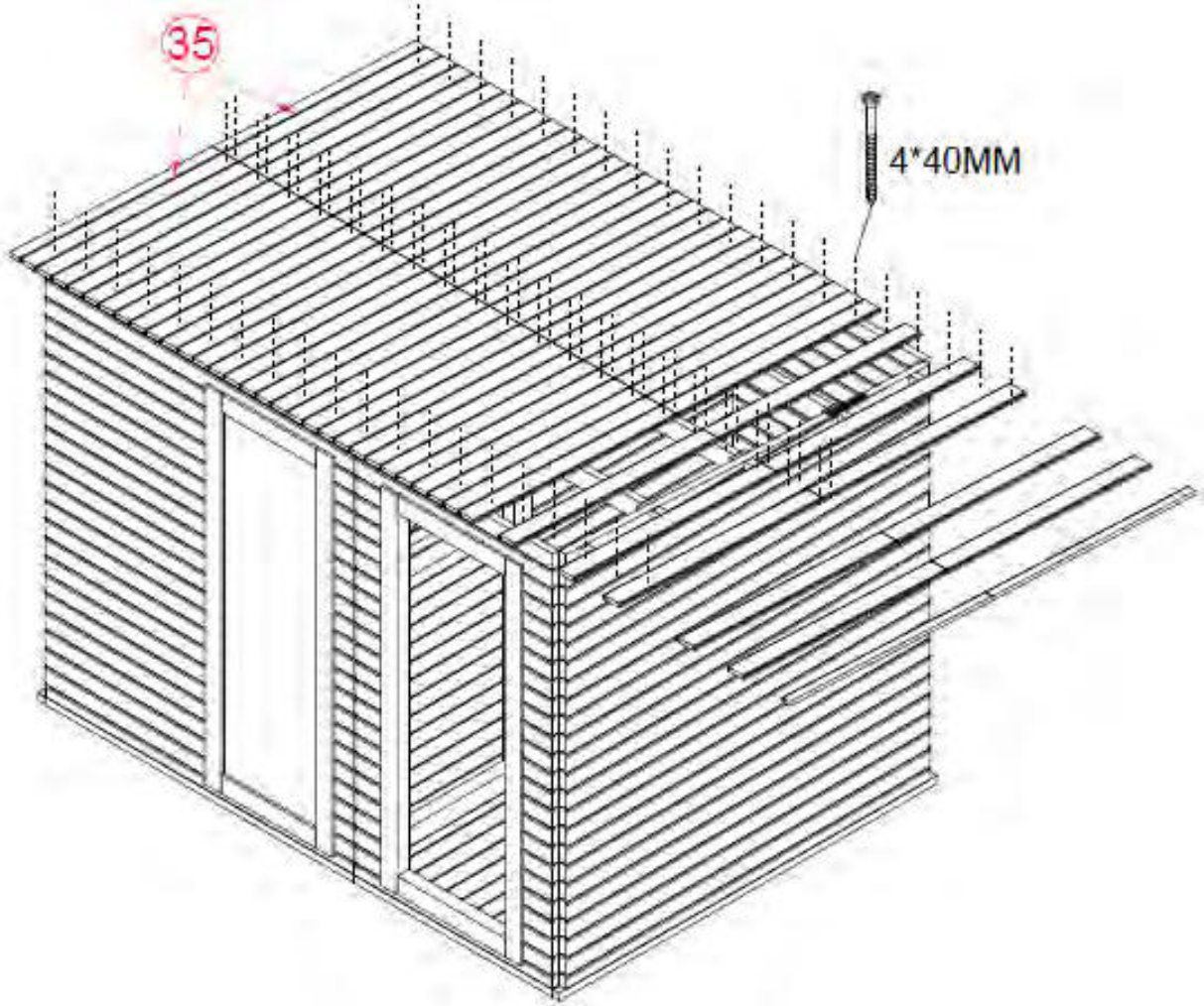

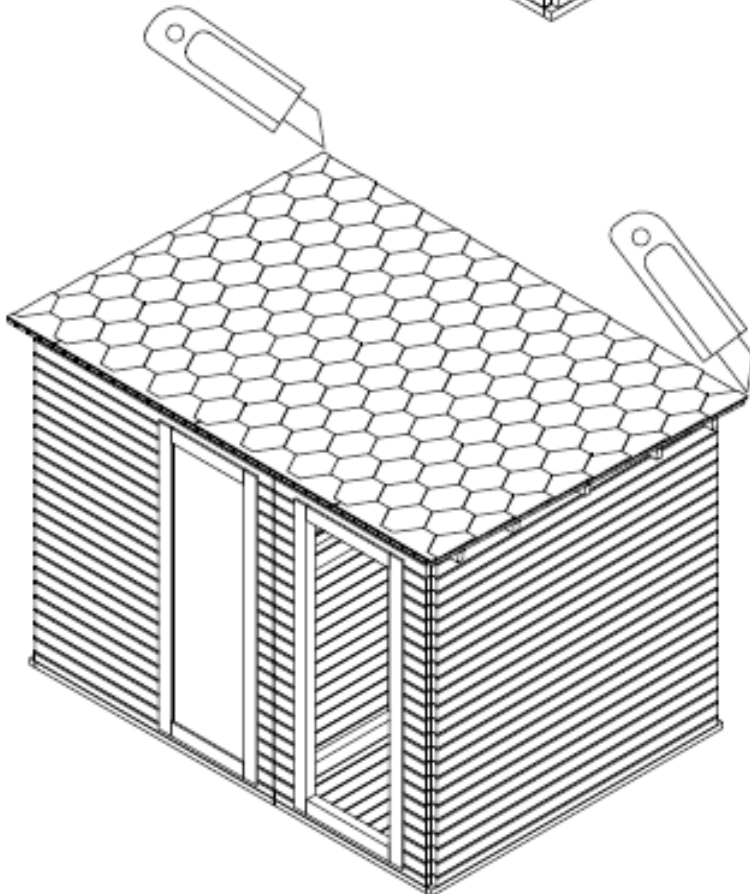
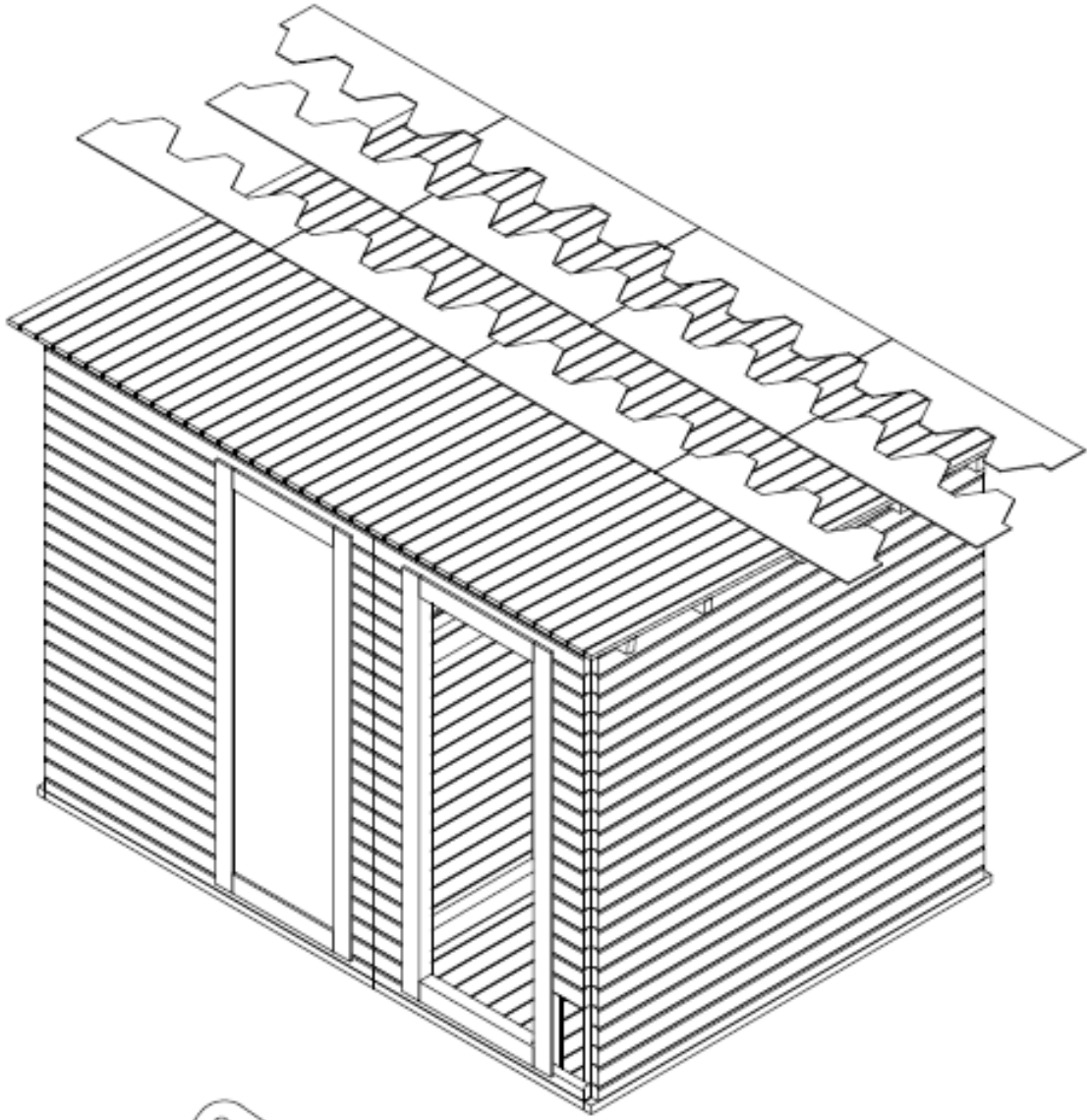

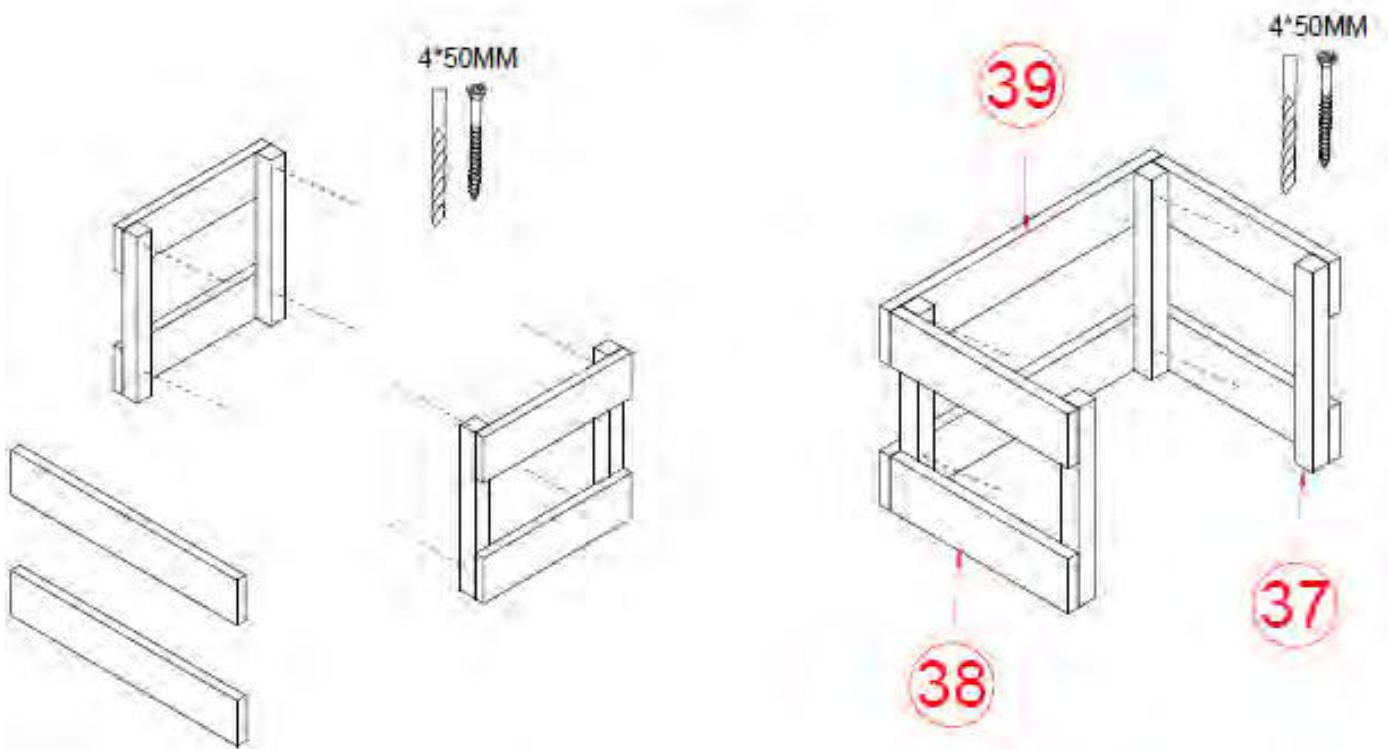
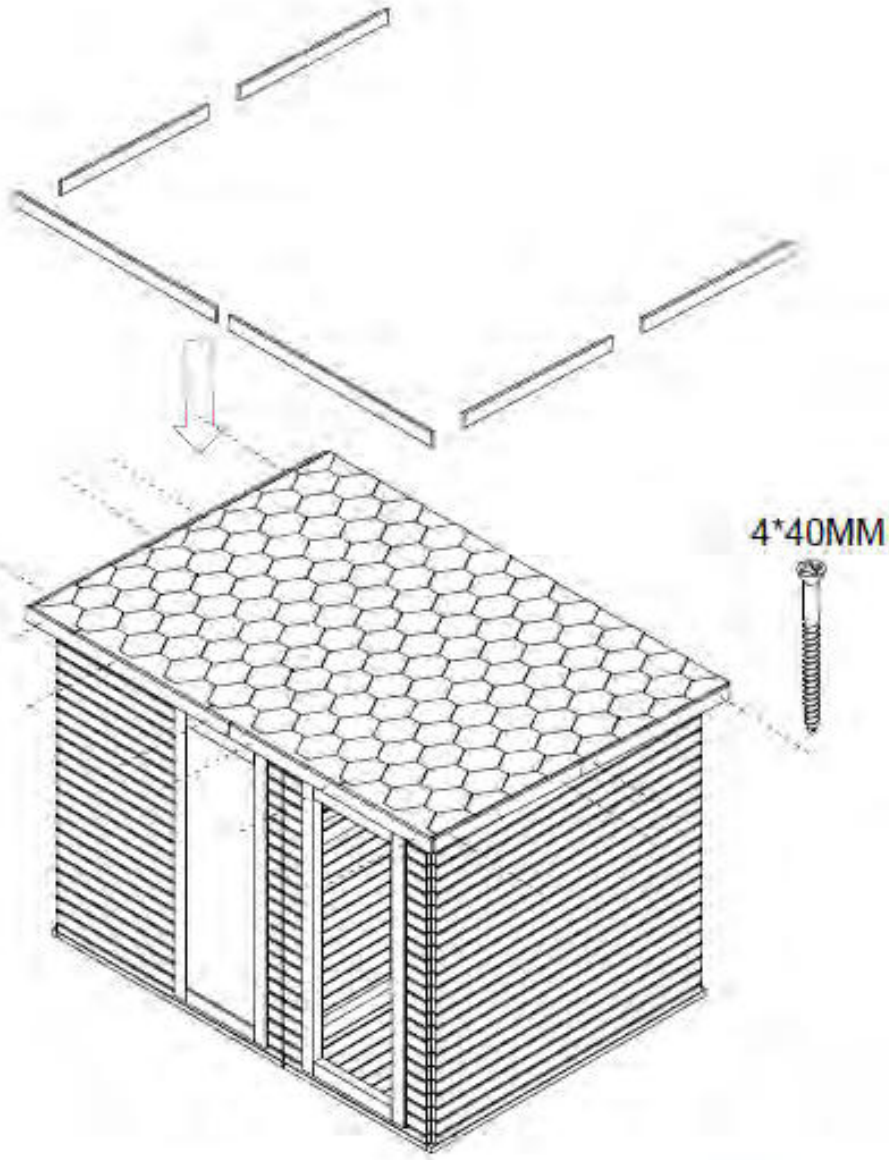

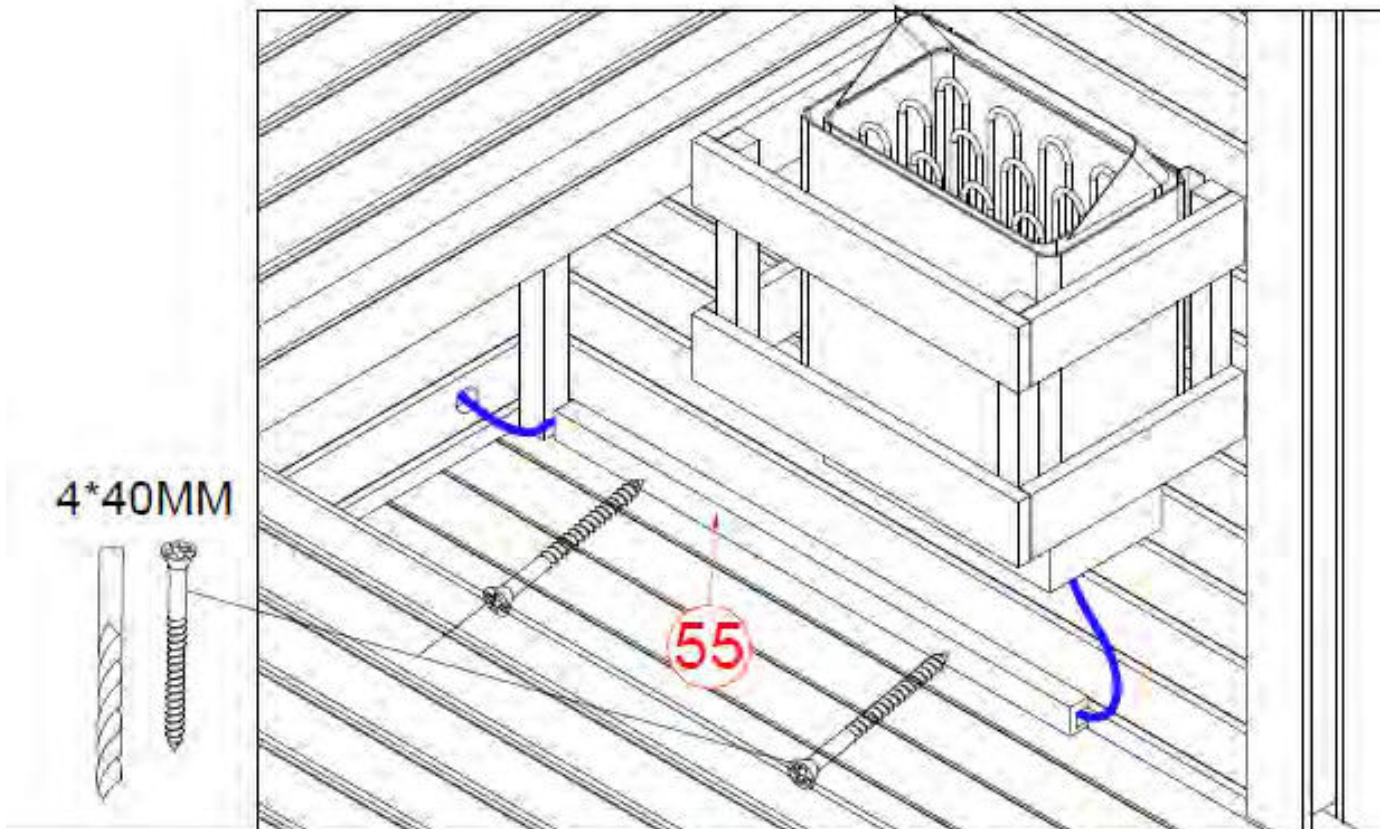
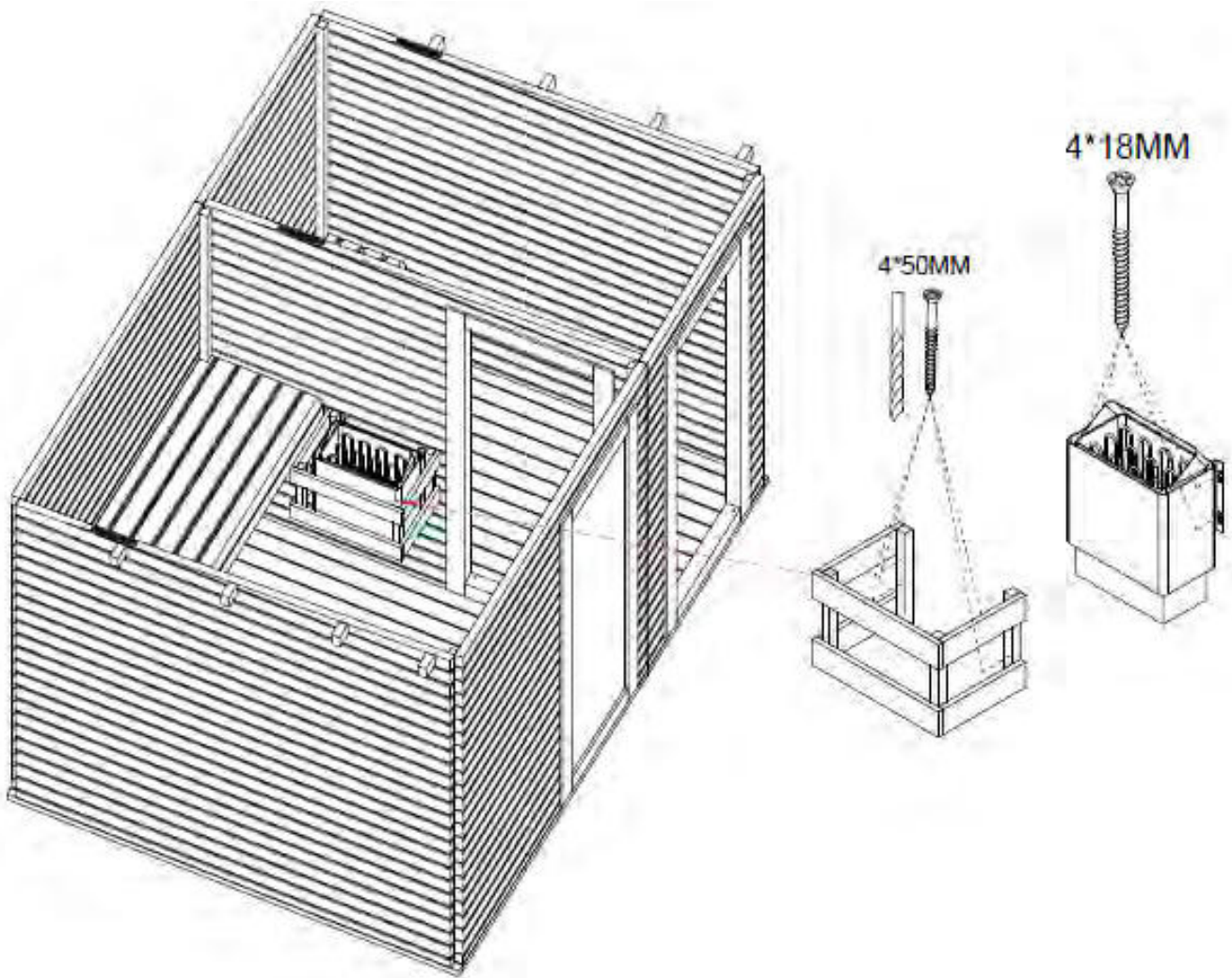

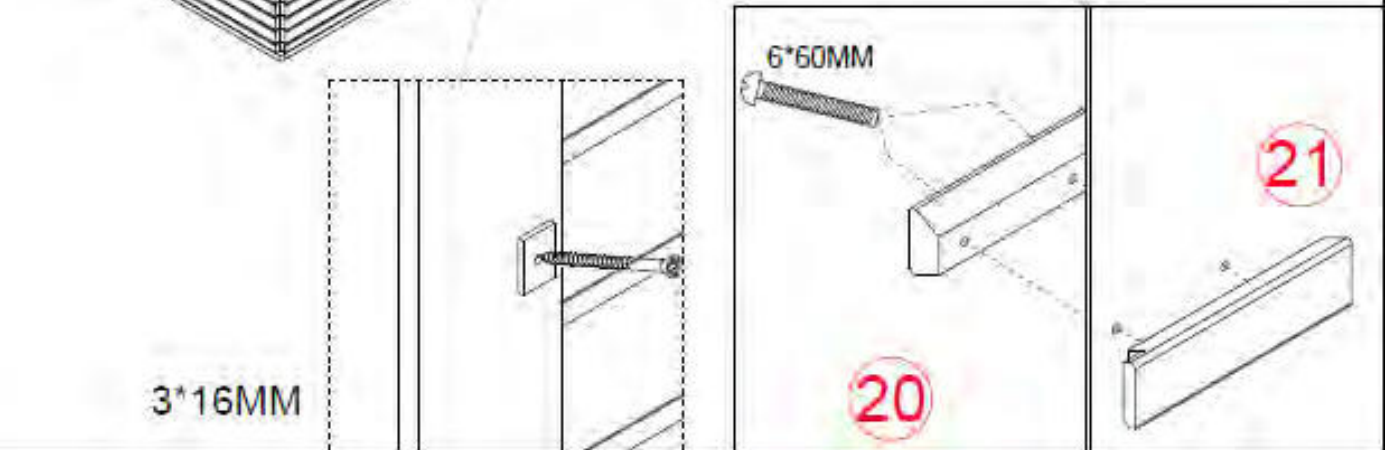
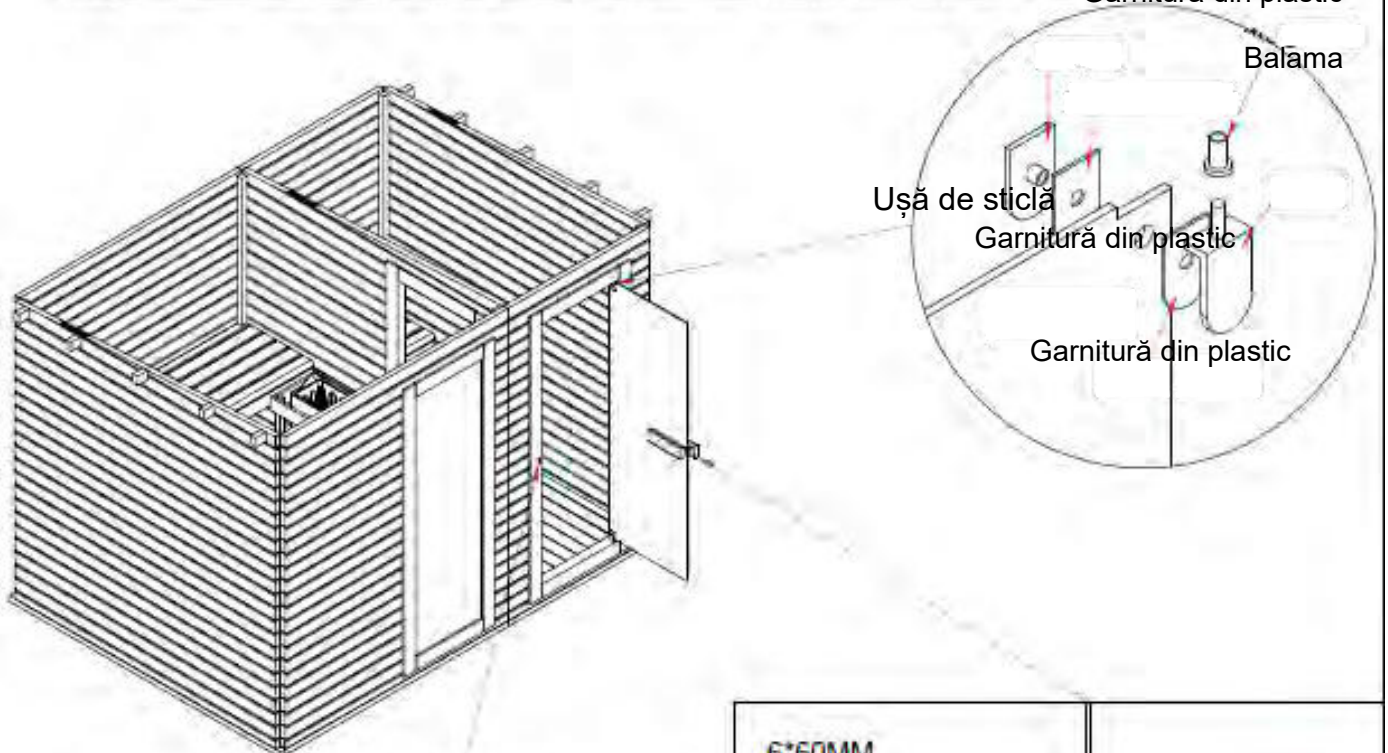
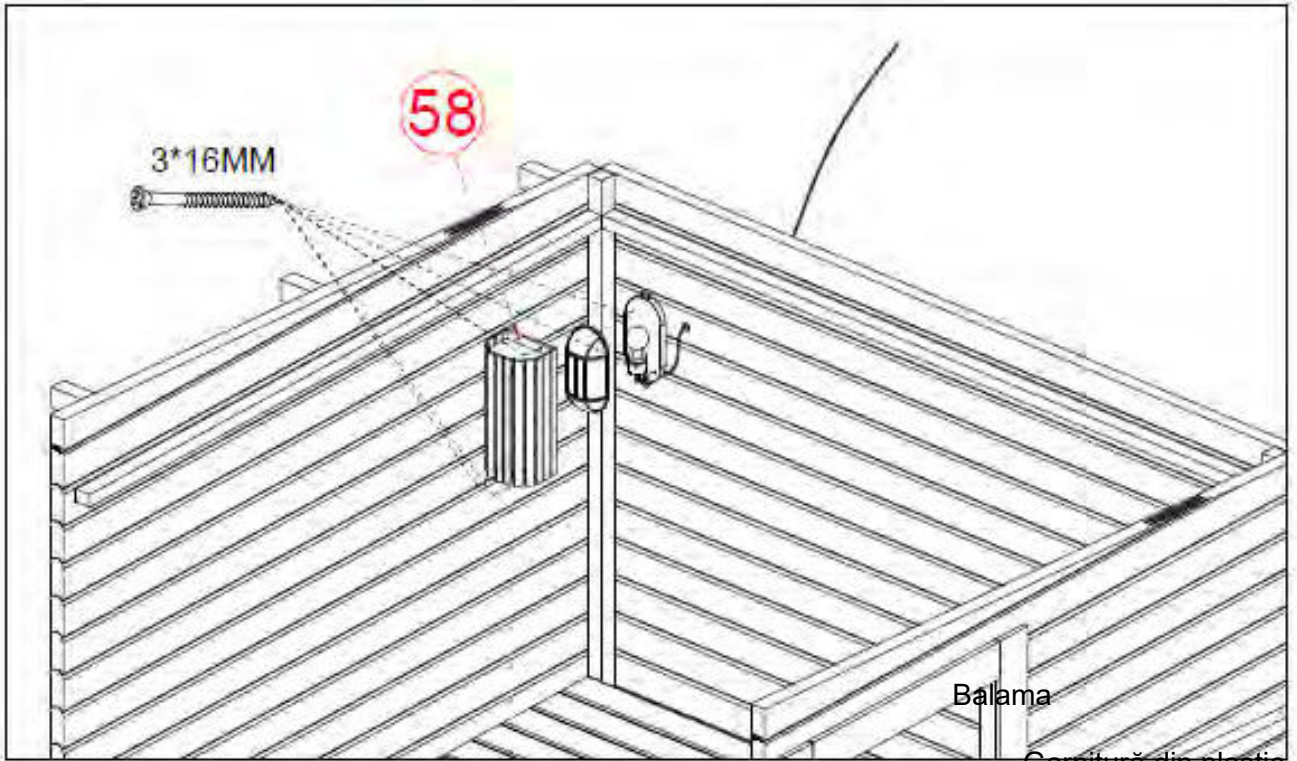

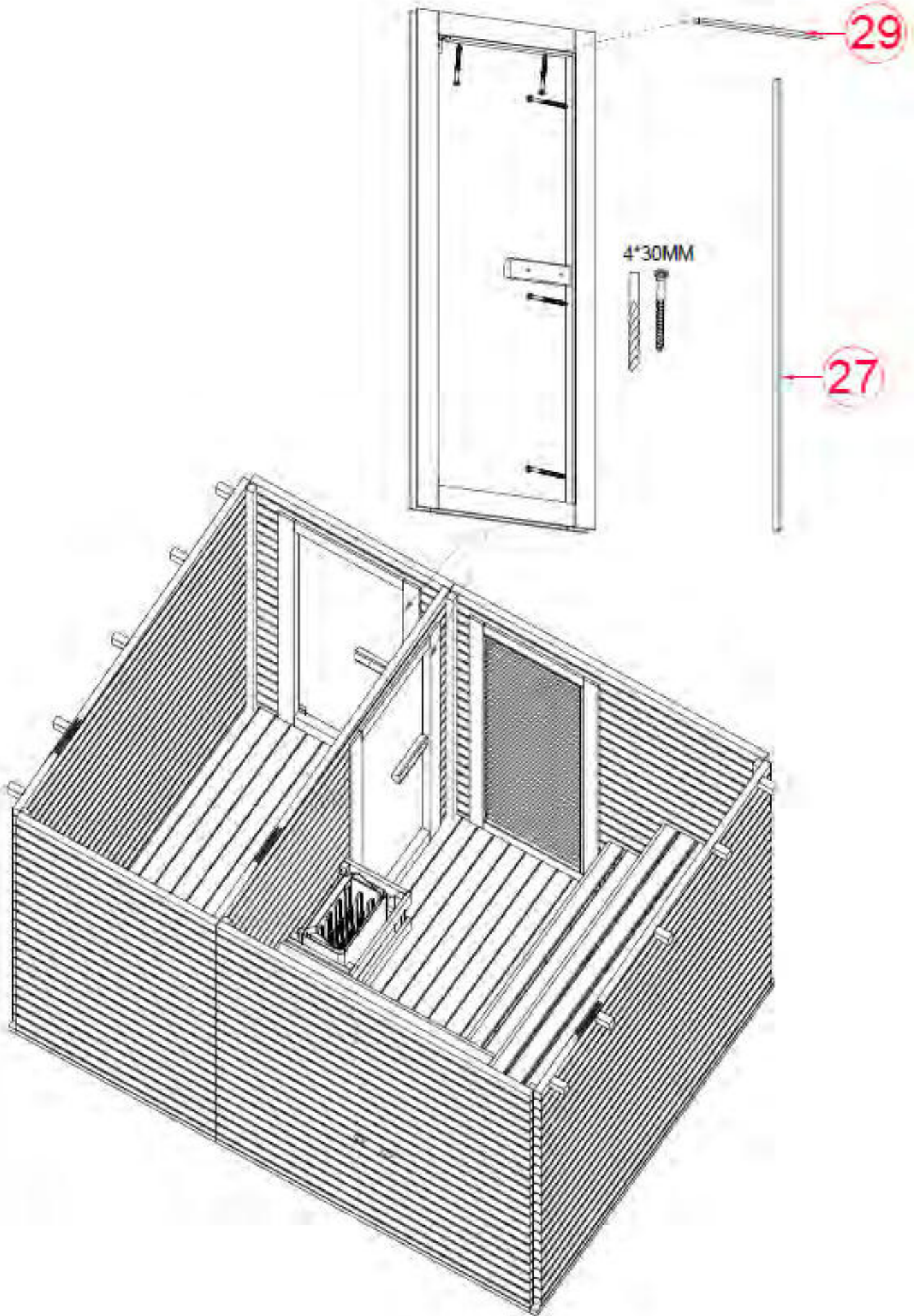

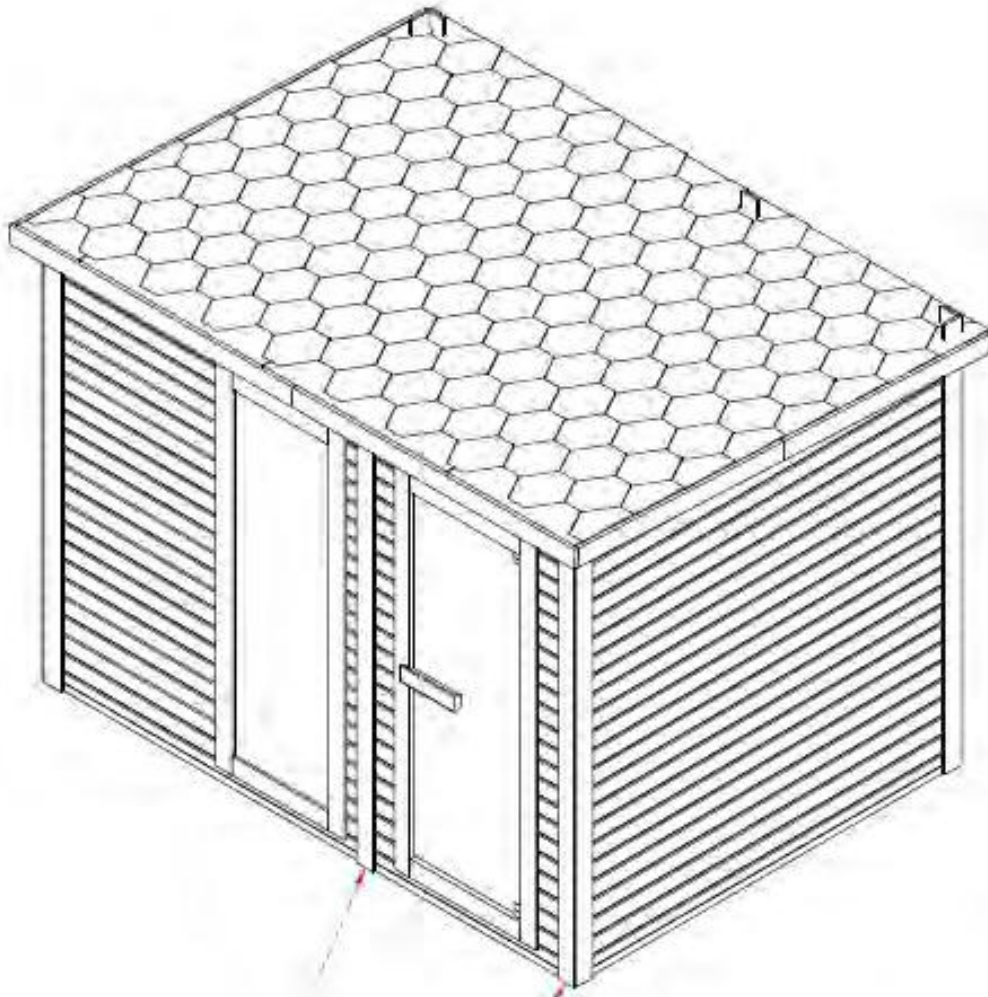

16

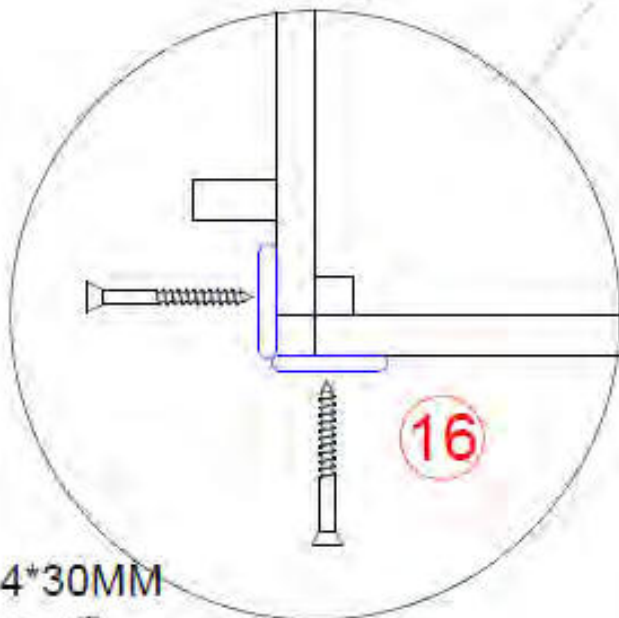

4*30MM

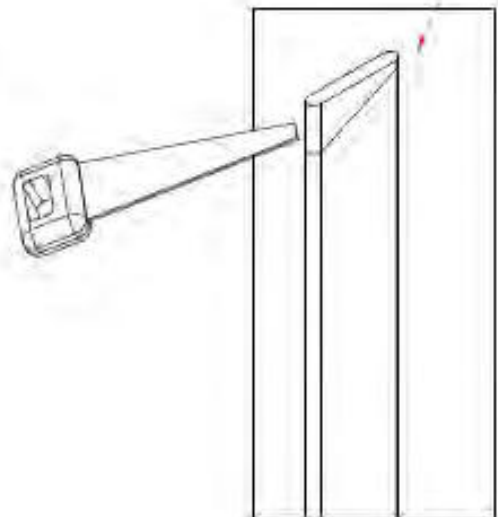

16

F30310

Návod na používanie

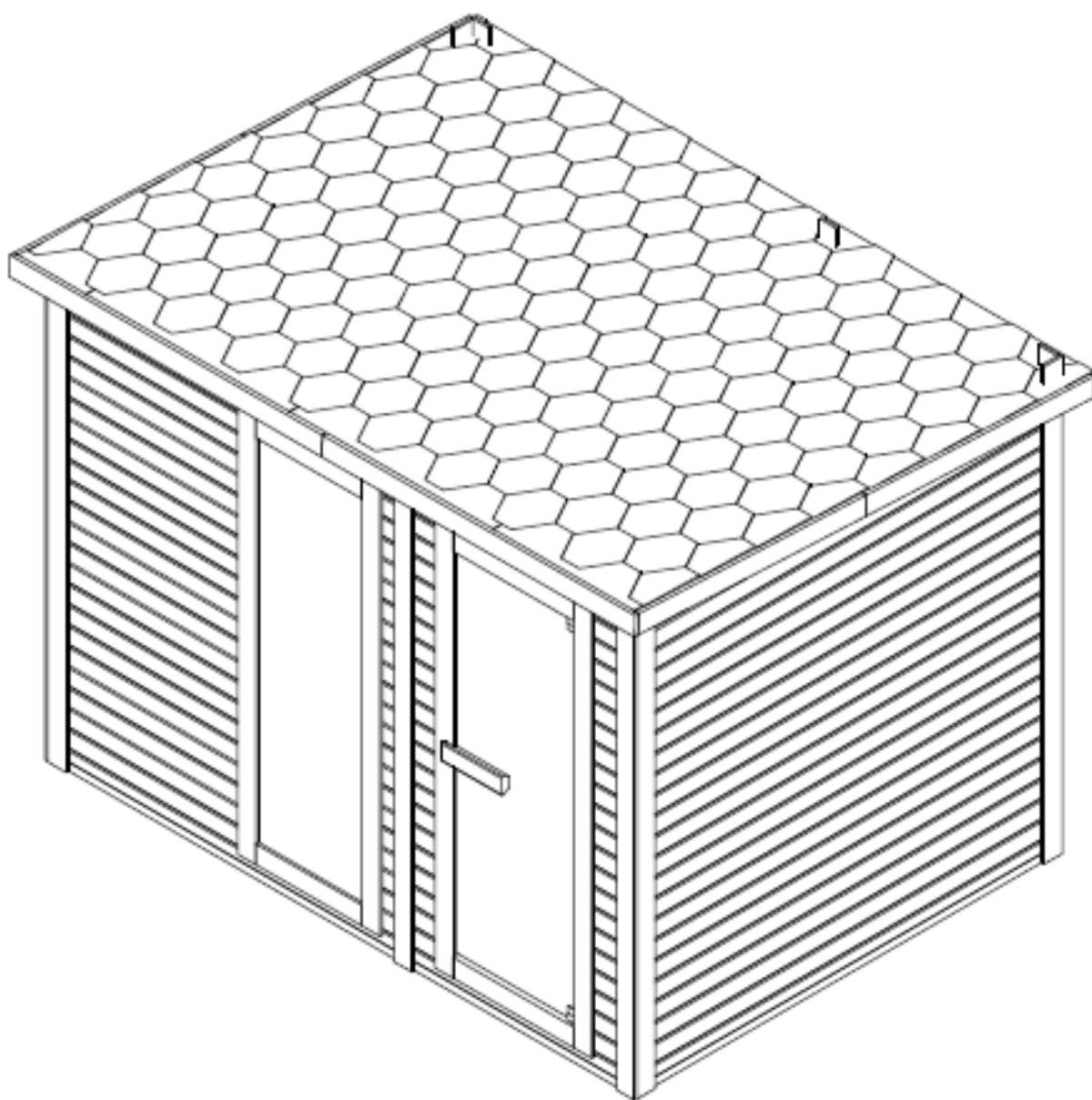

POZORNOSŤ

Pred prvým použitím sauny si pozorne prečítajte túto príručku.

Odporúčame vám ho uložiť na bezpečnom mieste, aby ste ho mohli v budúcnosti znova použiť.

Dbajte na sériové číslo ovládacej skrinky v kabíne, pretože toto číslo je potrebné v prípade opravy alebo objednávky náhradných dielov.

- Drevo je živý prvok. Pre zachovanie pôvodného vzhľadu je dôležité ošetriť vonkajšiu stranu dreva proti vlhkosti.
- Saunu umiestnite na dokonale rovný a tvrdý povrch.
- Nepoužívajte tekuté čistiace prostriedky. Pred čistením saunu vypnite a použite vlhkú handričku.
- Chráňte napájací kábel sauny, aby sa nerozdrvil alebo nepricviknel.
- Pred výmenou určitých komponentov sa uistite, že sú predpísané výrobcom alebo majú rovnaké vlastnosti ako originálne diely. Nesprávna výmena môže spôsobiť požiar, skrat alebo poškodenie sauny. Dôrazne odporúčame zavolať kvalifikovaného technika.
- Aby ste predišli riziku popálenia alebo úrazu elektrickým prúdom, nepoužívajte kovové náradie.
- Zvieratá nemajú povolený vstup do sauny.
- Nenechávajte saunu zapnutú bez dozoru.
- Nenechávajte saunu zapnutú dlhšie ako 1 hodinu, aby ste predišli predčasnému poškodeniu zariadenia. Po 1 hodine nepretržitého používania saunu vypnite aspoň na 30 minút.
- Na dvere sauny sa odporúča neinštalovať uzamykací systém.
- Pred pripojením sauny k elektrickej sieti skontrolujte, či vaša elektroinštalácia spĺňa požiadavky.
- Inštaláciu a opravy môže vykonávať iba kvalifikovaný elektrikár!
- Používajte iba originálne diely.
- Keď saunu nepoužívate, vypnite ju.

NEBEZPEČENSTVO

- Zakrytie kachlí vedie k riziku požiaru v dôsledku prehriatia. Nezakrývajte vykurovacie telesá!
- Horľavé alebo vysoko horľavé materiály/predmety (napr. uteráky) vždy držte mimo dosahu saunového ohrievača.
- Nedotýkajte sa ohrievača počas a krátko po použití, pretože hrozí nebezpečenstvo popálenia horúcimi časťami.
- Žiarovka sa počas prevádzky zahrieva. Ak je potrebné žiarovku vymeniť, odpojte ju od kabíny a nechajte žiarovku vychladnúť pred ich výmenou vychladnúť.

Bezpečnosť

DÔLEŽITÝ!

Pred nastavením a používaním saunovej kabíny si pozorne prečítajte bezpečnostné pokyny. Upozornenia sú dôležité pre vašu bezpečnosť, preto ich prísne dodržiavajte.

Dávajte pozor na hypertermiu, úpal alebo vyčerpanie z tepla, ktoré môže byť spôsobené alebo zhoršené nedodržaním bezpečnostných pokynov. Príznaky zahŕňajú horúčku, rýchly pulz, závraty, mdloby, letargiu a necitlivosť v celom tele alebo častiach tela. Účinky sú: znížené vnímanie tepla, nevedomosť o hroziacich nebezpečenstvách, strata vedomia.

Saunu nesmú využívať:

- Deti do 6 rokov.
- Ľudia so silnými reakciami na slnečné svetlo.
- Ľudia s už existujúcimi ochoreniami, ako sú srdcové choroby, vysoký alebo nízky krvný tlak, poruchy krvného obehu alebo cukrovka bez predchádzajúcej lekárskej pomoci.
- Tehotné ženy. Nadmerná teplota môže ohroziť plod.
- Ľudia, ktorí trpia dehydratáciou, otvorenými ranami, očnými chorobami, popáleninami alebo úpalom.

Deťom vo veku od 6 do 16 rokov je povolený vstup do sauny za predpokladu, že sú pod neustálym dohľadom zodpovednej dospeléj osoby a teplota nepresiahne 60 °C.

V prípade zdravotných problémov, liekov alebo poranení svalov a väzov môžete saunu využívať len po predchádzajúcej konzultácii s lekárom a jeho súhlase.

Ak máte chirurgické implantáty, nesmiete saunu používať bez predchádzajúcej konzultácie s lekárom a získania jeho súhlasu.

Saunu nepoužívajte po namáhavých aktivitách.

Počkajte 30 minút, kým vaše telo vychladne.

V saune netrávte v kuse viac ako 40 minút.

Nekonzumujte alkohol ani drogy pred alebo počas sedenia.

Nespíte v saune, keď je v prevádzke.

Aby ste predišli riziku prehriatia, zapojte saunu do dostatočne výkonnej zásuvky a do tej istej zásuvky nepripájajte iné elektrické spotrebiče.

Aby ste predišli riziku úrazu elektrickým prúdom alebo poškodenia sauny, nesmie sa používať:

- Počas búrky.
- Ak je elektrický kábel poškodený, musí ho vymeniť kvalifikovaná osoba.
- Ak sa napájací kábel prehreje, musí ho skontrolovať kvalifikovaná osoba.
- Ak potrebujete vymeniť žiarovku, počkajte, kým sauna zhasne a vychladne.

Pred zapojením alebo vypnutím napájania si osušte ruky.

Nikdy nepracujte mokrými rukami alebo nohami.

Nezapínajte ani nevypínajte rýchlo napájanie ani kúrenie, pretože by to mohlo poškodiť elektrický systém.

Nepokúšajte sa sami opravovať saunu bez súhlasu predajcu sauny alebo výrobcu.

Neoprávnené pokusy o opravu spôsobia stratu záruky výrobcu.

V saune nepoužívajte čistiace prostriedky.

Neukladajte ani neskladujte predmety v saune alebo na nej.

V blízkosti sauny neumiestňujte horľavé materiály alebo chemické látky.

Nezakrývajte vykurovacie telesá!





Nedotýkajte sa ohrievača počas a krátko po použití, pretože hrozí nebezpečenstvo popálenia v dôsledku horúcich častí.



Keď kabínu nepoužívate, vypnite ju.

Špecifikácie:

Model	F30310
Materiál kabíny	Smrek
Hĺbka	2300 mm
Šírka	3100 mm
Výška	2200 mm
Napätie	AC380V
Ohrievač	8 kW

Montážny materiál (možné odchýlky)

											
Ø3x16	Ø4x70	Ø4x60	Ø4x50	Ø4*40	Ø4*30	Ø4*18	Ø5*100	Ø6x60	Wood pad		
6x	103x	300x	76x	240x	62x	40x	2x	4x	2x	2x	4x

		
2x	10x	2x

Pred začatím montáže odstráňte prepravný obal a skontrolujte, či bola vaša infračervená kabína dodaná kompletná a neporušená.

Pred nájdením vhodného miesta pre saunu si pozorne prečítajte montážny návod. Sauna je určená výhradne pre vonkajšiu inštaláciu.

Vyberte oblasť:

- Na suchom mieste na rovnom, stabilnom povrchu, ktorý unesie váhu vašej sauny.
- Výška musí byť dostatočná, aby ste dosiahli strop a vykonávali elektrické pripojenia a údržbu.
- Uchovávajte mimo dosahu vodných zdrojov, plameňov alebo horľavých materiálov.
- Požadovaná minimálna výška miestnosti je 2,02 m

Praktické rady

- Upozorňujeme, že na zriadenie sauny sú potrebné aspoň 2 dospelé osoby.
- Pred začatím jedinečne identifikujte každý panel
- Pri inštalácii položte napájací kábel sauny tak, aby bol ľahko prístupný.
- Upozorňujeme, že medzi modelmi sú rozdiely.

DÔLEŽITÝ:





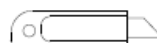
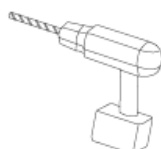
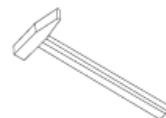
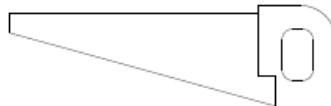
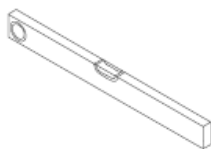



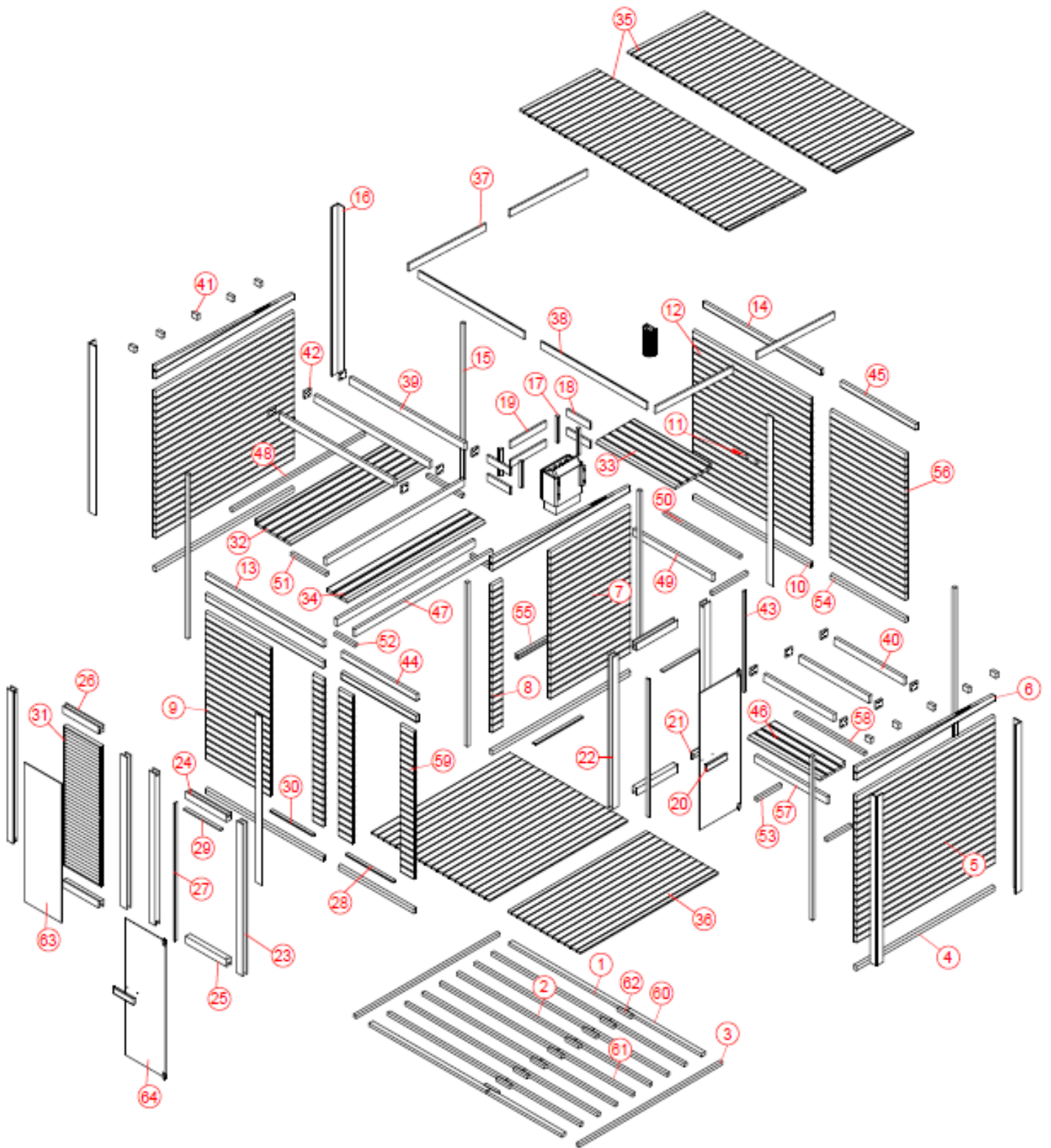

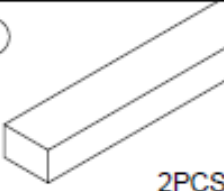
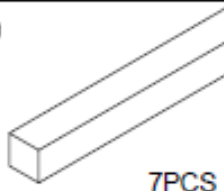
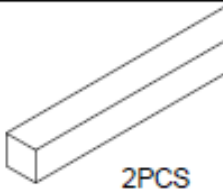
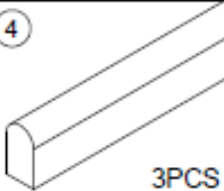
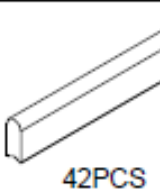
Skontrolujte zahĺbenie a priemer otvoru vyvŕtaných otvorov, aby ste predišli poškodeniu dreva.

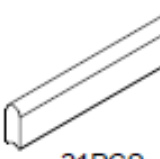

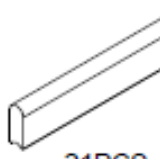

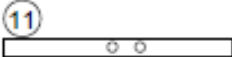
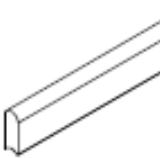
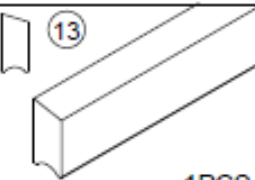
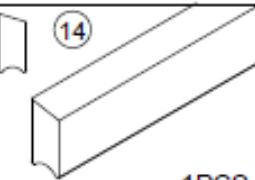
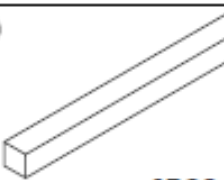
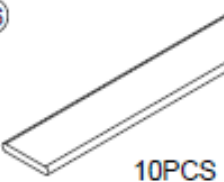
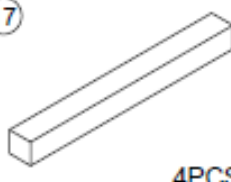
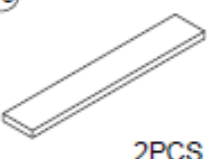
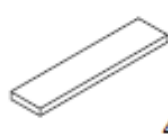
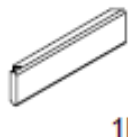
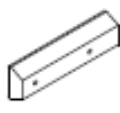
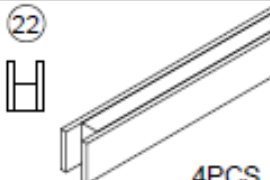
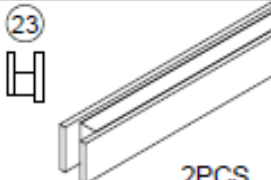
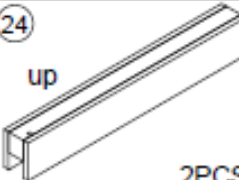
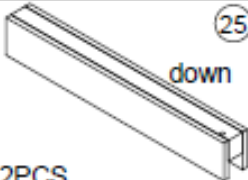
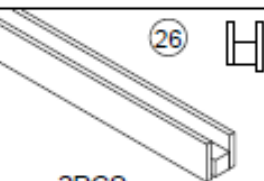
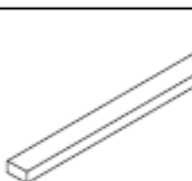
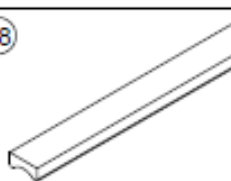
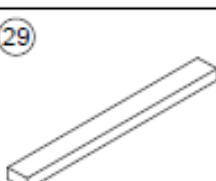
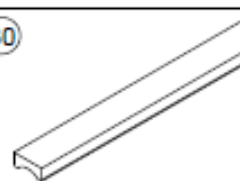

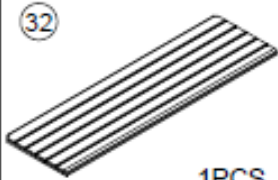
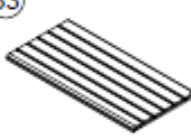

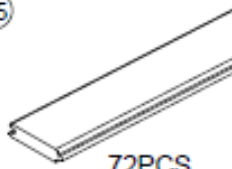
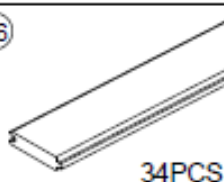
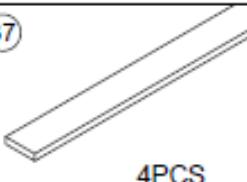
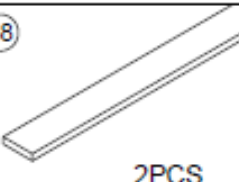
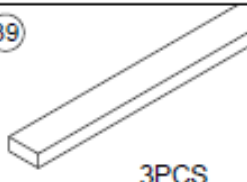
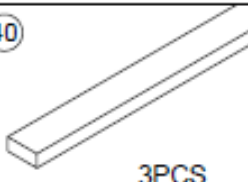



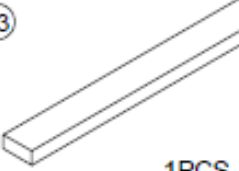

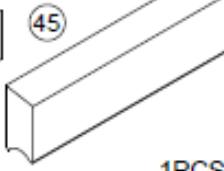
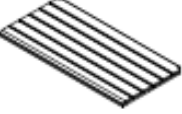
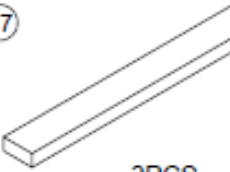
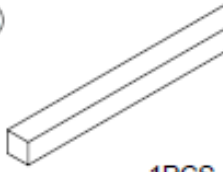
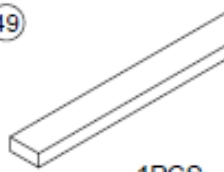
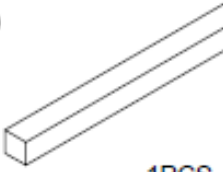
Náradie:

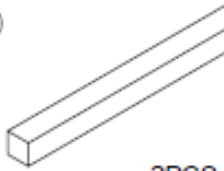
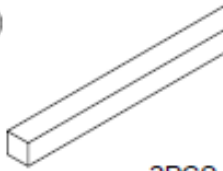

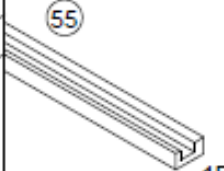
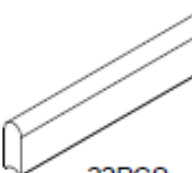
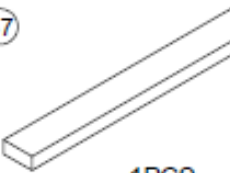
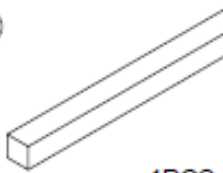
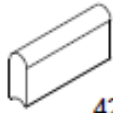
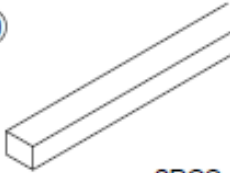
Kusovník:

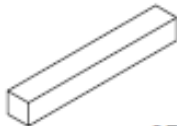
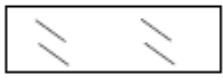
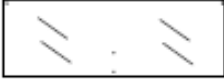

①  2PCS 1724*55*38mm	②  7PCS 1724*38*38mm	③  2PCS 2100*38*38mm	④  3PCS 2024*67*38mm	⑤  42PCS 2024*97*38mm
⑥  3PCS 2024*168*38mm	⑦  21PCS 1172*97*38mm	⑧  42PCS 150*97*38mm	⑨  21PCS 945*97*38mm	⑩  2PCS 1724*67*38mm
⑪  1PCS 1724*97*38mm	⑫  21PCS 1724*97*38mm	⑬  1PCS 1724*81*38mm	⑭  1PCS 1724*70*38mm	⑮  6PCS 2188*38*38mm
⑯  10PCS 2140*90*13mm	⑰  4PCS 330*33*33mm	⑱  2PCS 520*90*20mm	⑲  4PCS 340*90*20mm	⑳  1PCS 300*90*40mm
㉑  1PCS 252*90*40mm	㉒  4PCS 1927*90*66mm	㉓  2PCS 1927*90*66mm	㉔  2PCS 600*90*66mm	㉕  2PCS 600*90*66mm
㉖  2PCS 547*90*66mm	㉗  2PCS 1747*40*13mm	㉘  2PCS 700*38*17mm	㉙  2PCS 537*40*13mm	㉚  1PCS 627*38*17mm
㉛  1PCS 1765*545*47mm	㉜  1PCS 2022*560*33mm	㉝  1PCS 1162*560*33mm	㉞  1PCS 2022*300*33mm	㉟  72PCS 1130*97*18mm
㊱  34PCS 2022*97*18mm	㊲  4PCS 1132*90*20mm	㊳  2PCS 1552*90*20mm	㊴  3PCS 1684*90*38mm	㊵  3PCS 1022*90*38mm

 10PCS 80*60*38mm	 12PCS 90*90*20mm	 1PCS 1550*33*13mm	 1PCS 1100*81*38mm	 1PCS 1100*70*38mm
 1PCS 1060*400*33mm	 3PCS 2022*90*38mm	 1PCS 1946*38*38mm	 1PCS 1162*90*38mm	 1PCS 1124*38*38mm
 3PCS 522*38*38mm	 2PCS 300*38*38mm	 2PCS 362*38*38mm	 2PCS 1100*67*38mm	 1PCS 820*40*20mm
 22PCS 1100*97*38mm	 1PCS 1060*90*38mm	 1PCS 1022*38*38mm	 42PCS 198*97*38mm	 2PCS 1100*55*38mm
 7PCS 1100*38*38mm	 9PCS 200*38*38mm	 1PCS 1764*544*6mm	 1PCS 1733*594*6mm	 1PCS 300*142*105MM
 Sauna light	 Sauna stove	 69PCS 1000*320*5mm		

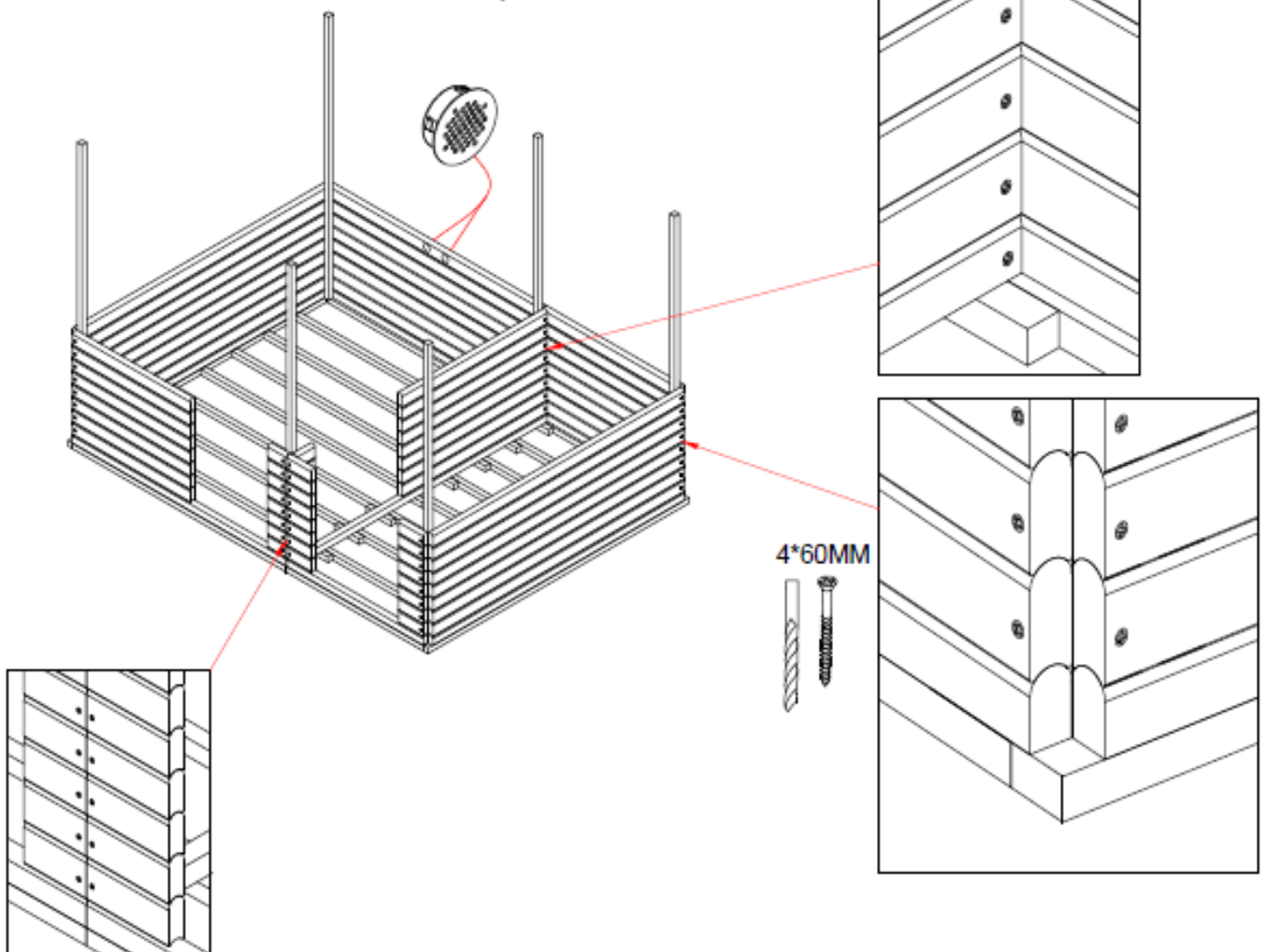
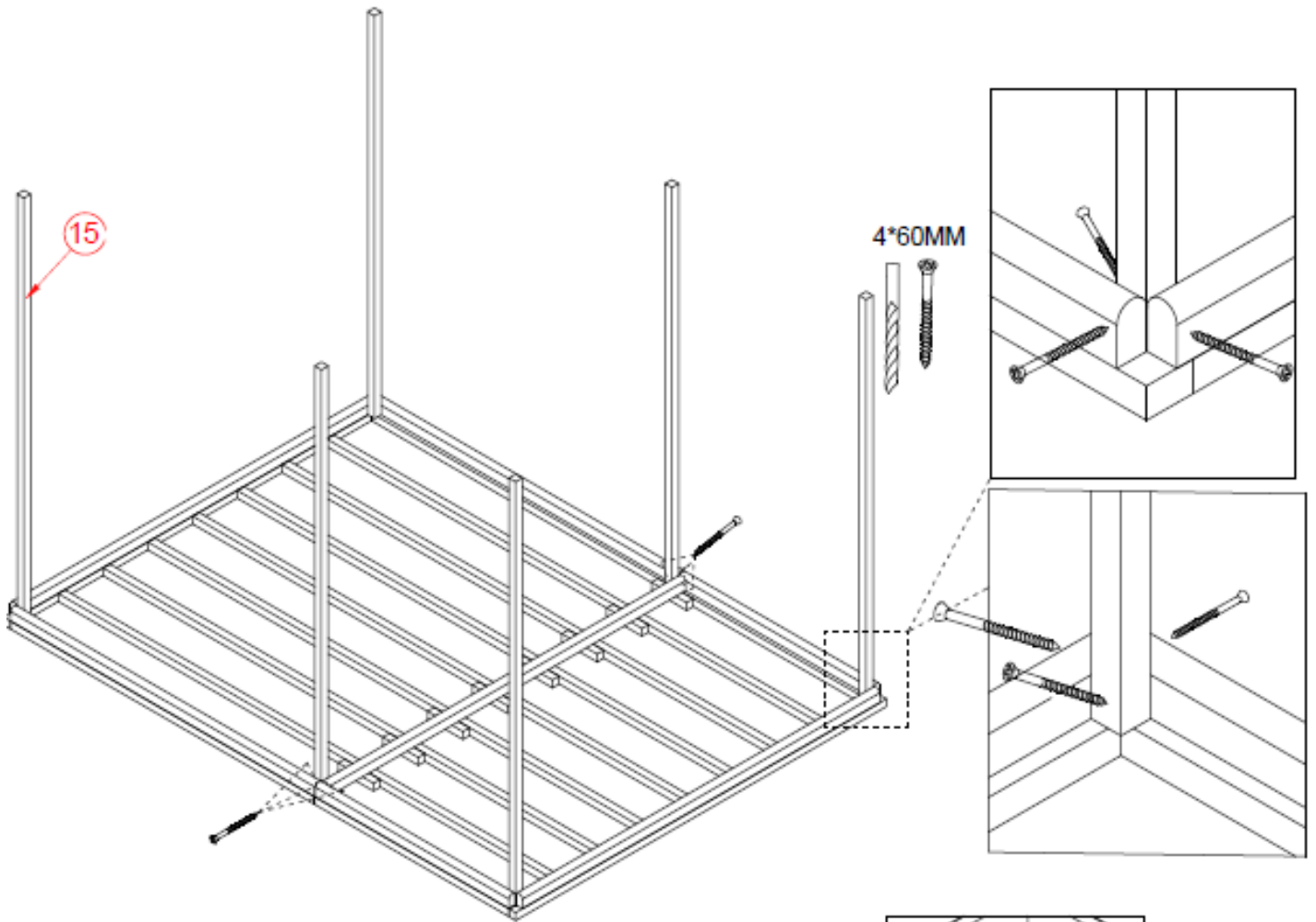

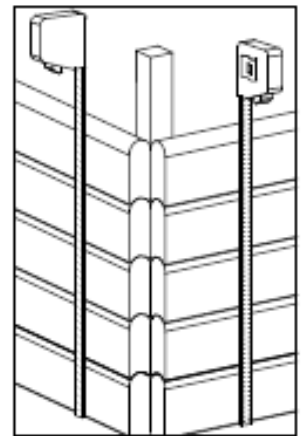
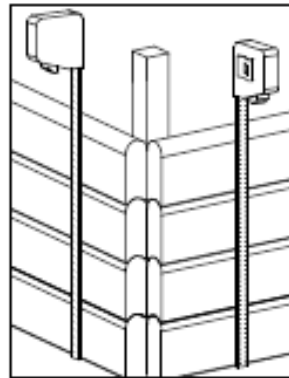
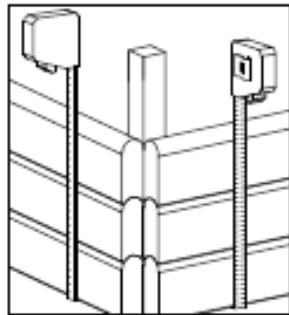
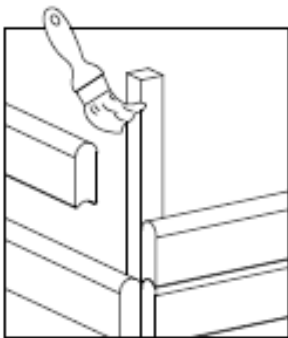
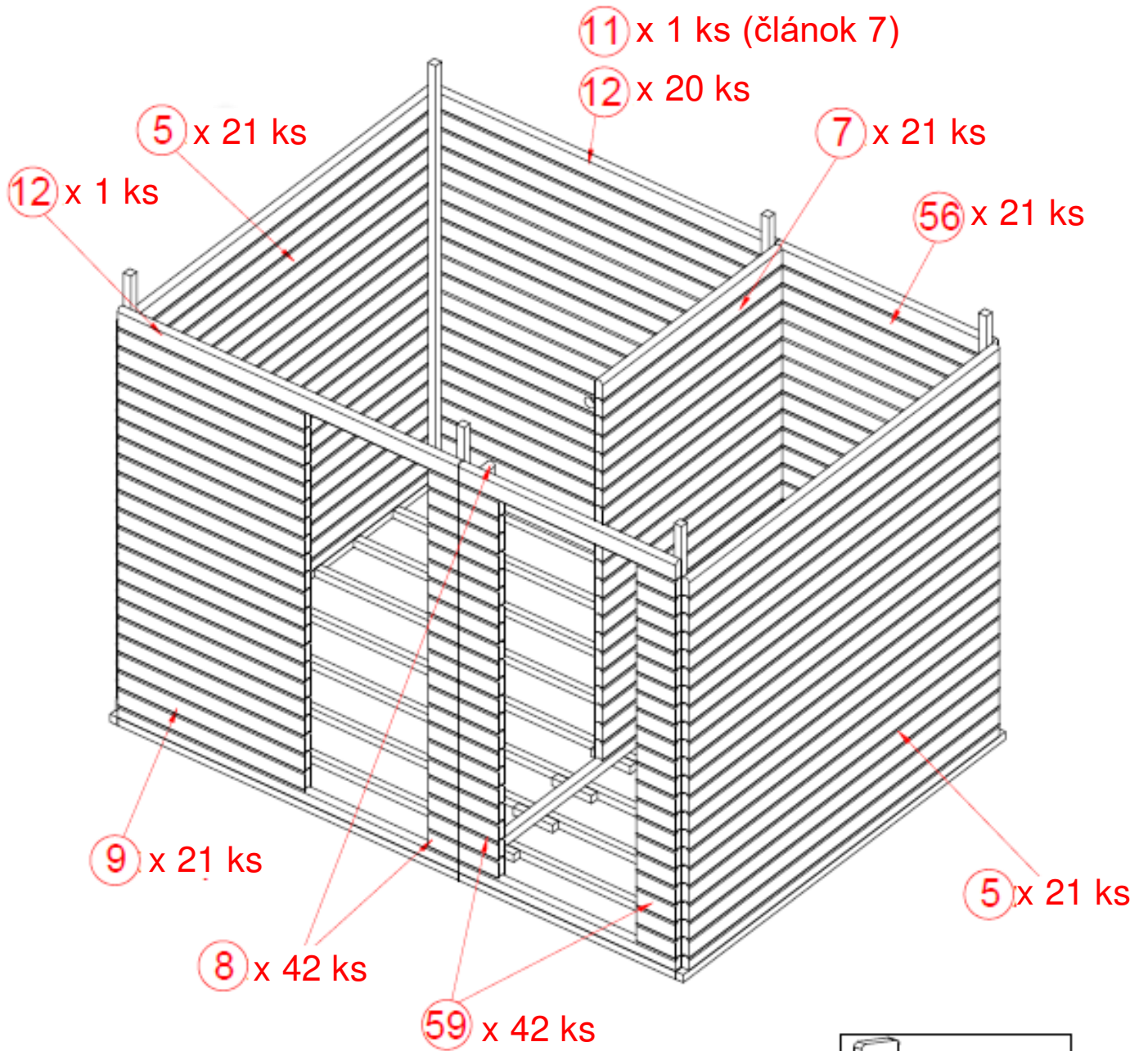

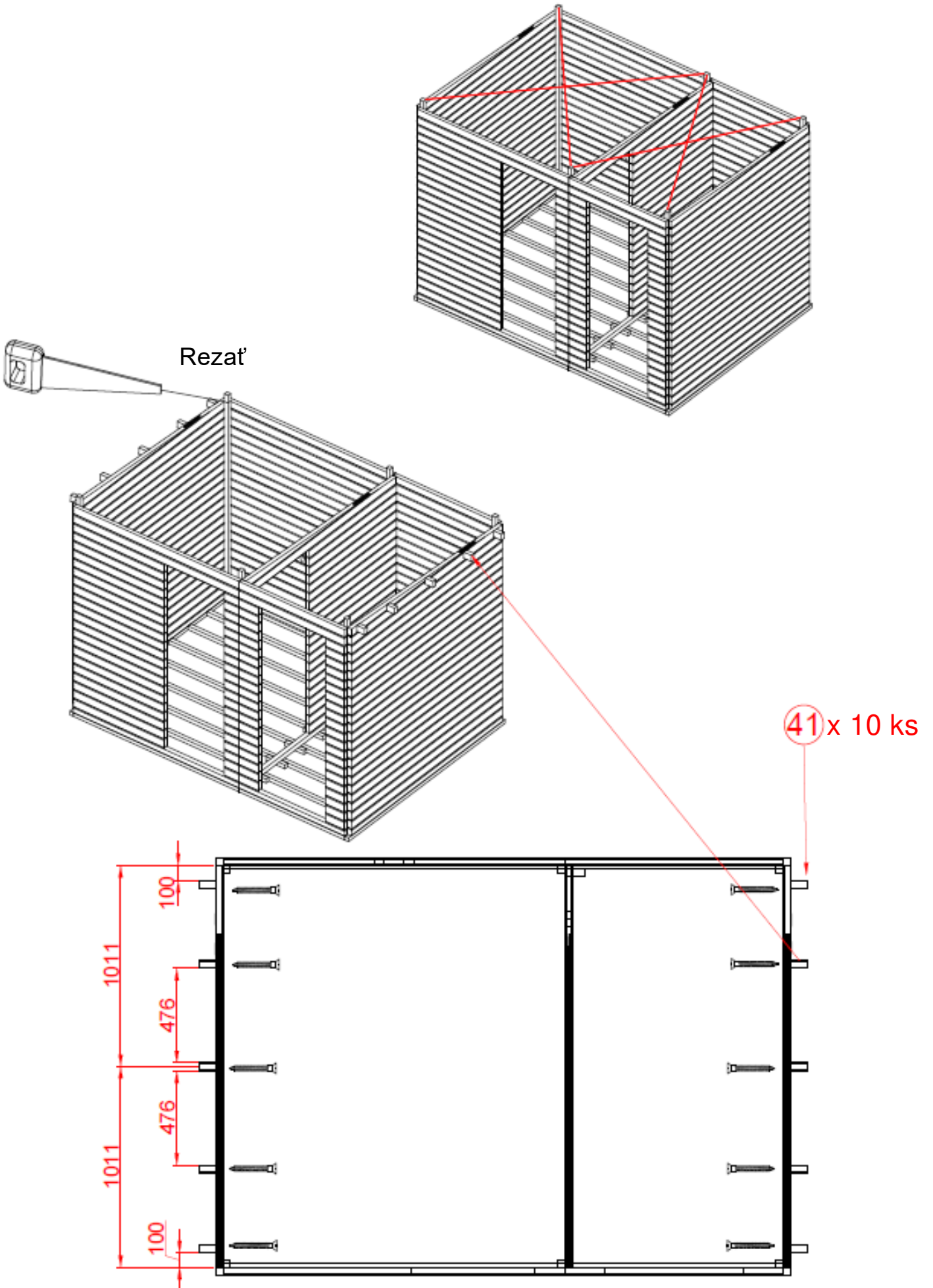

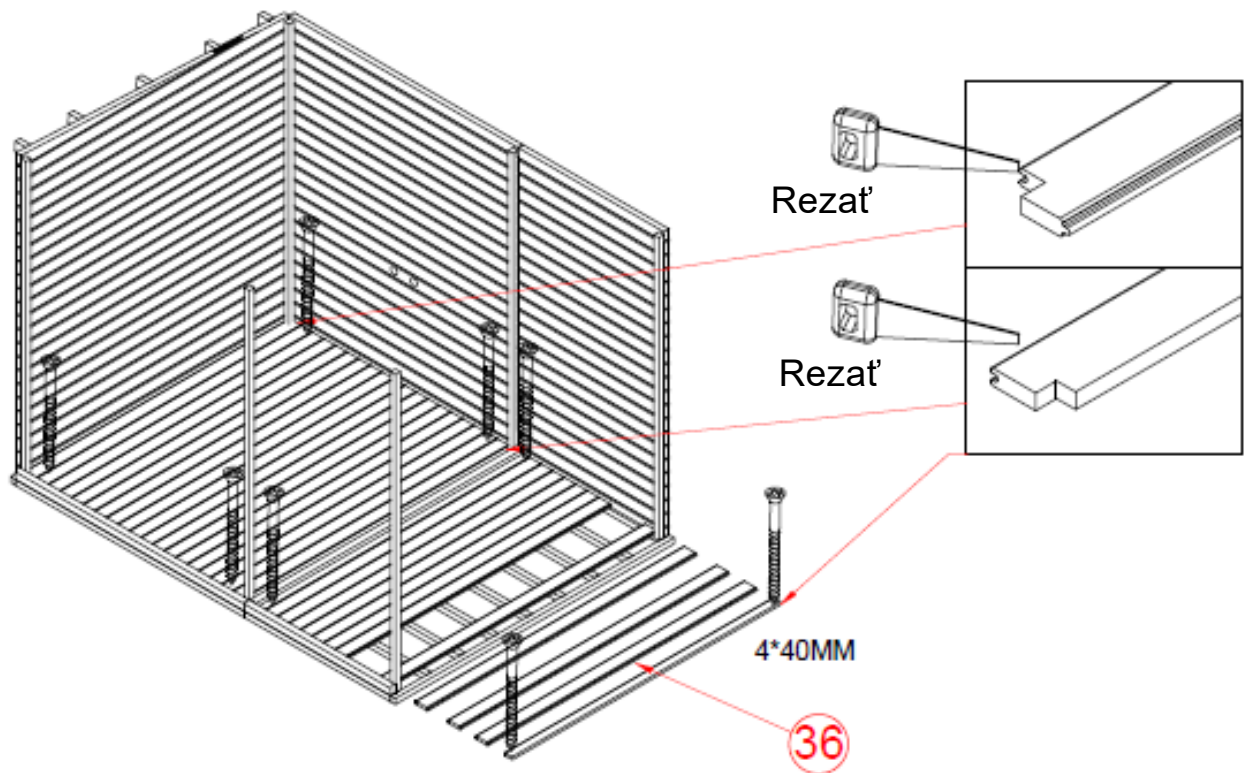
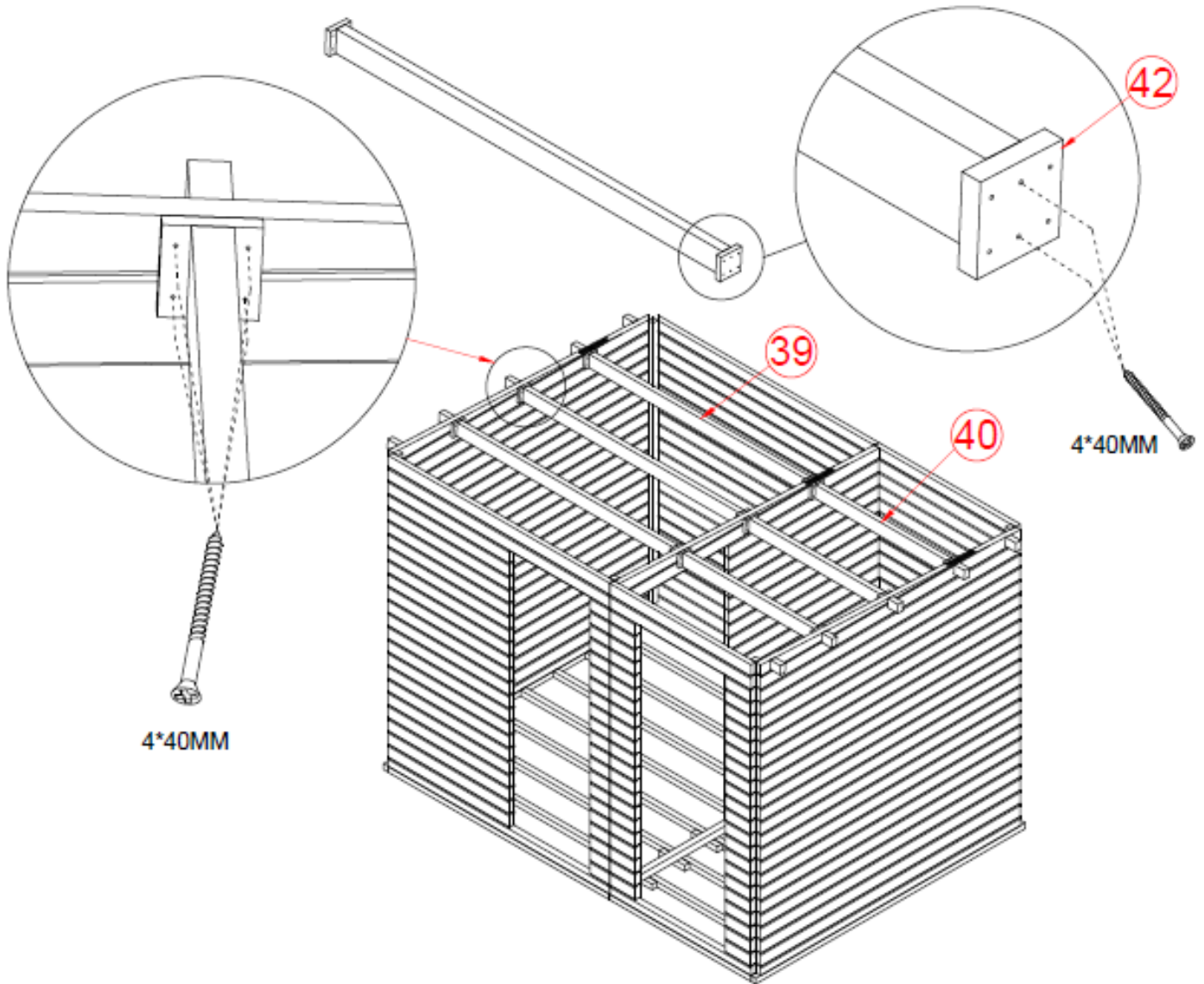

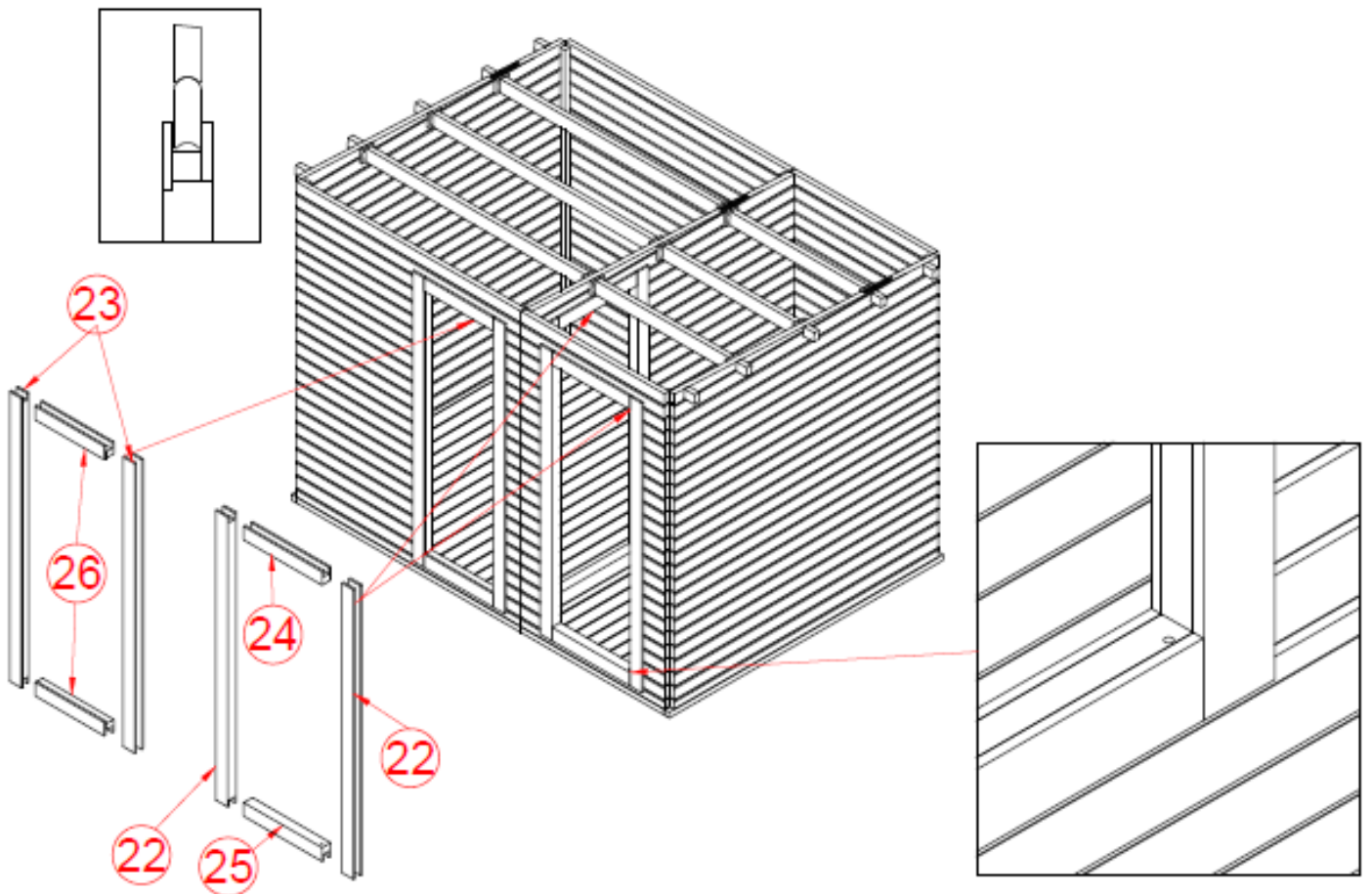
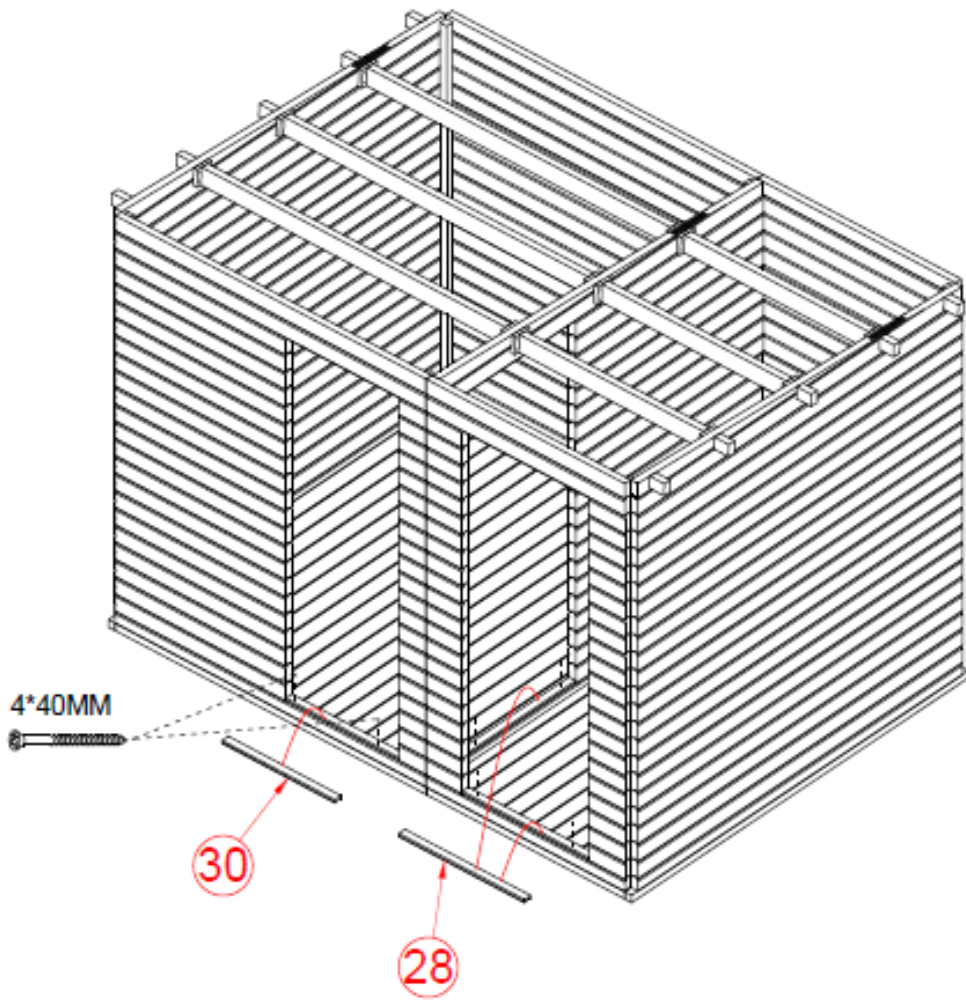

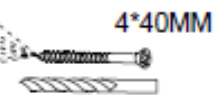
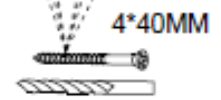
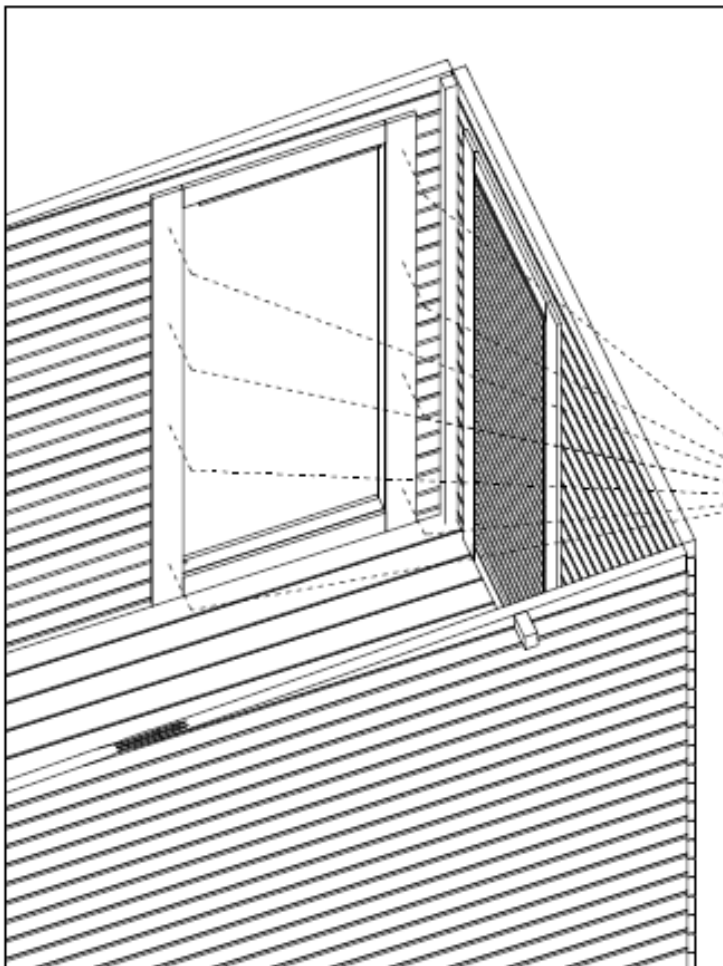
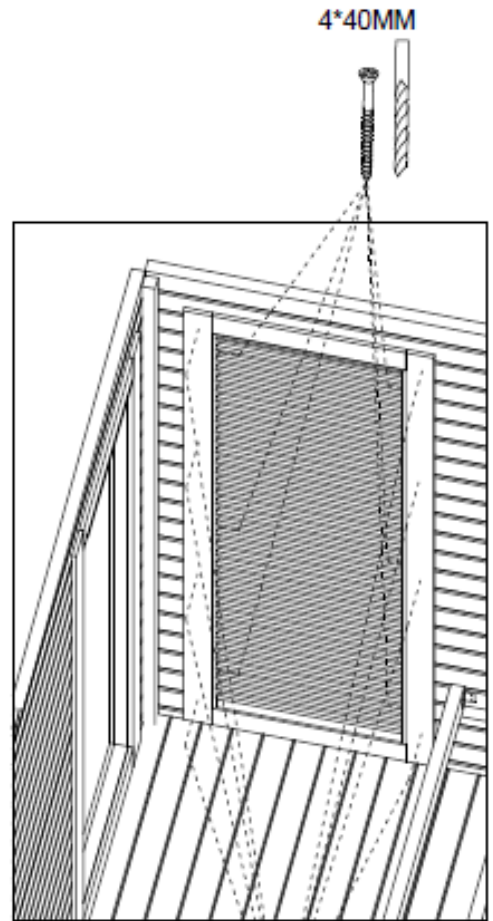
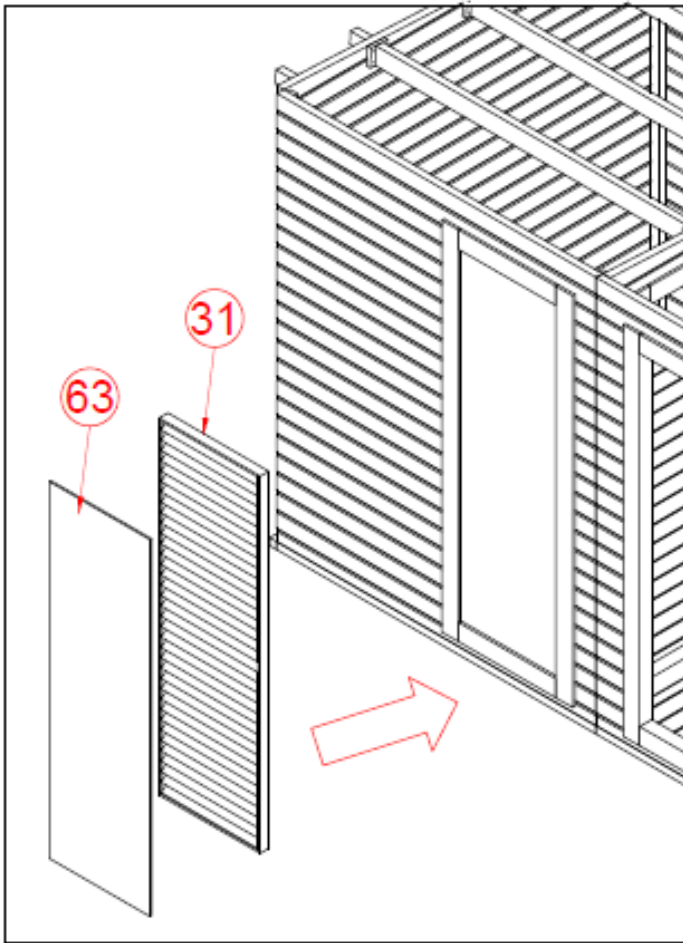

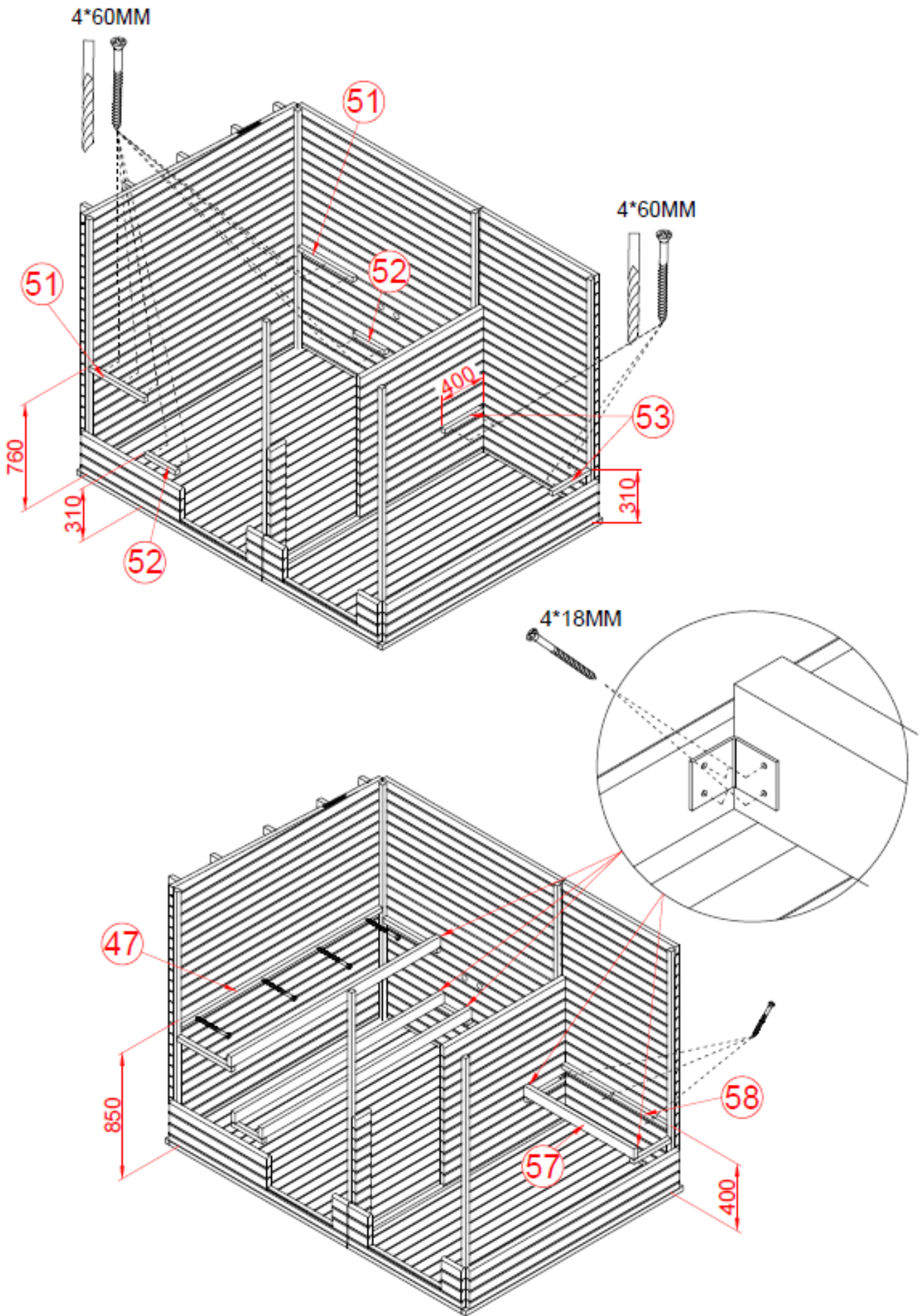

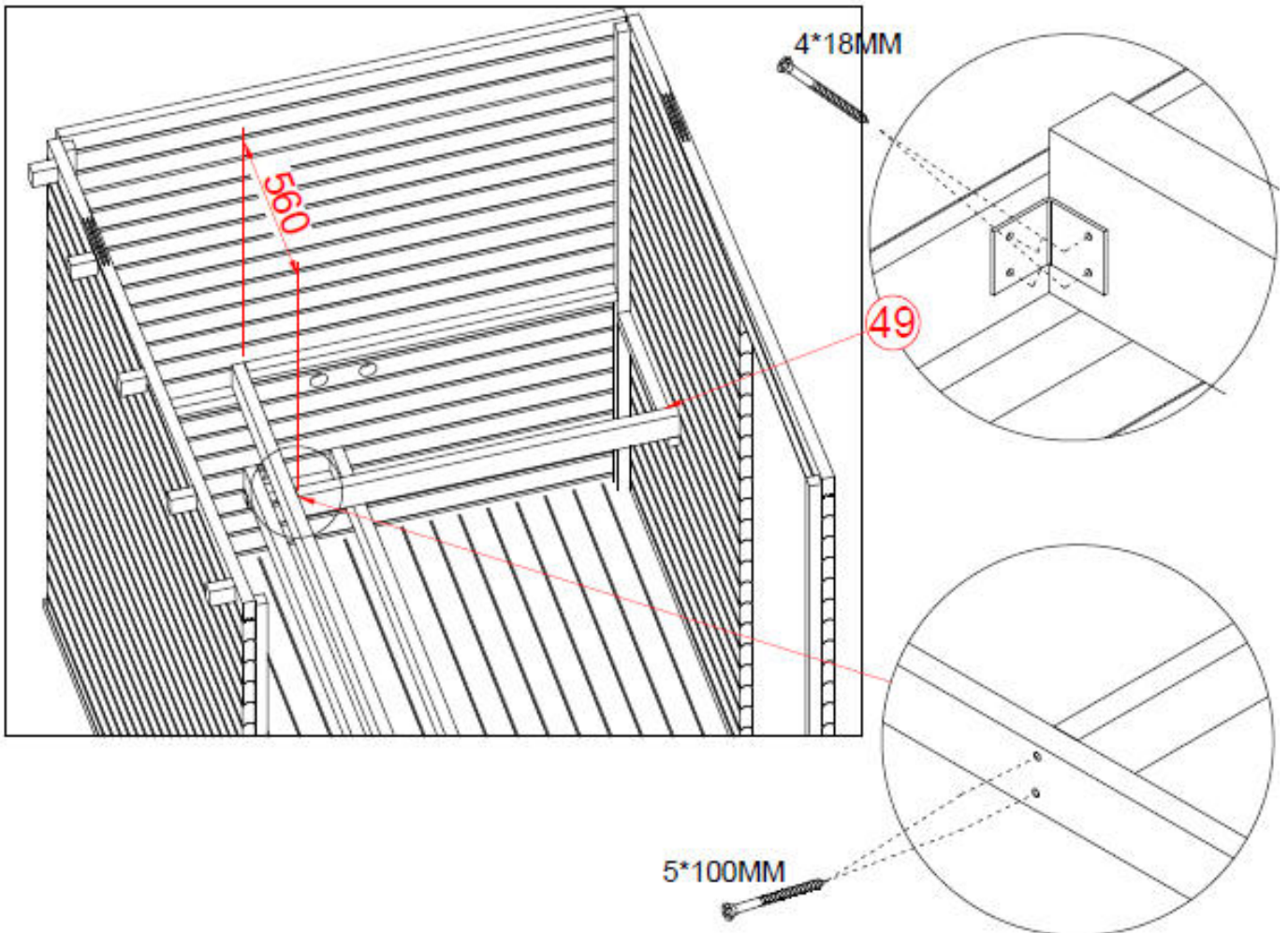
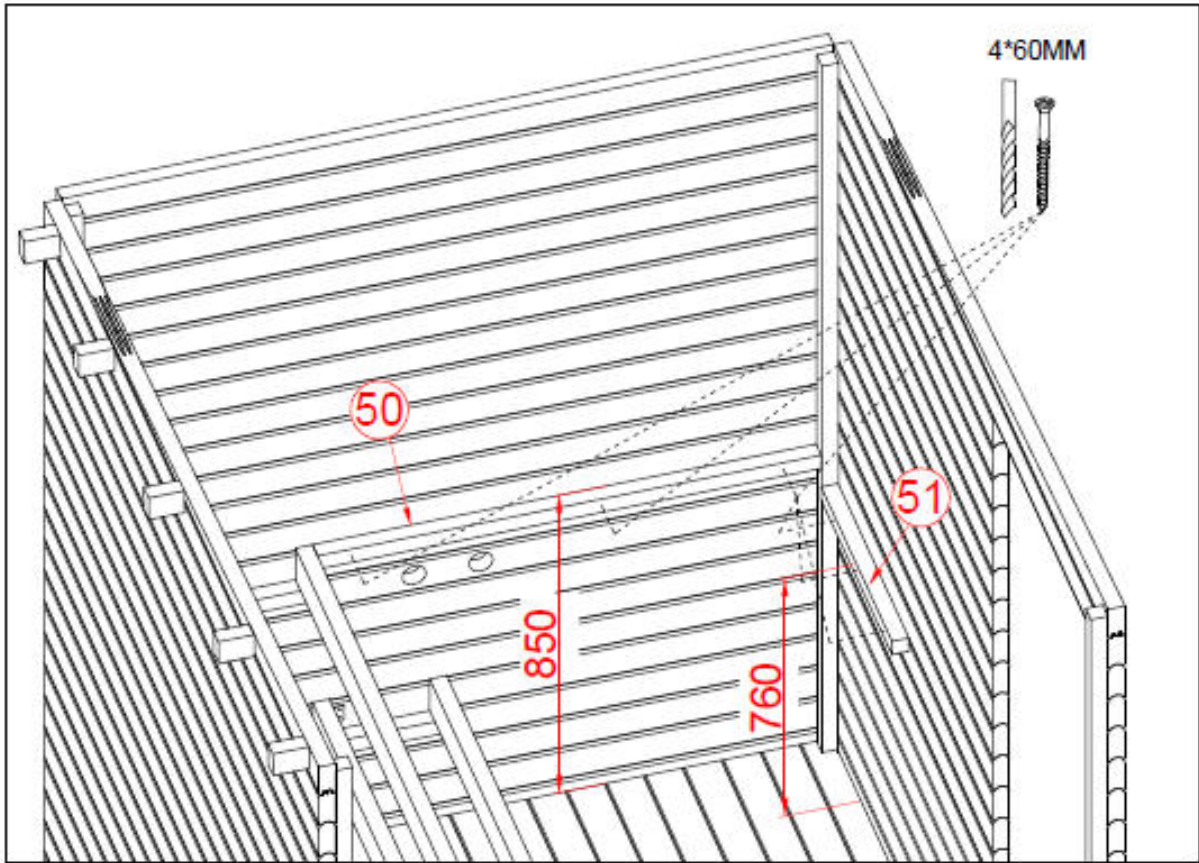

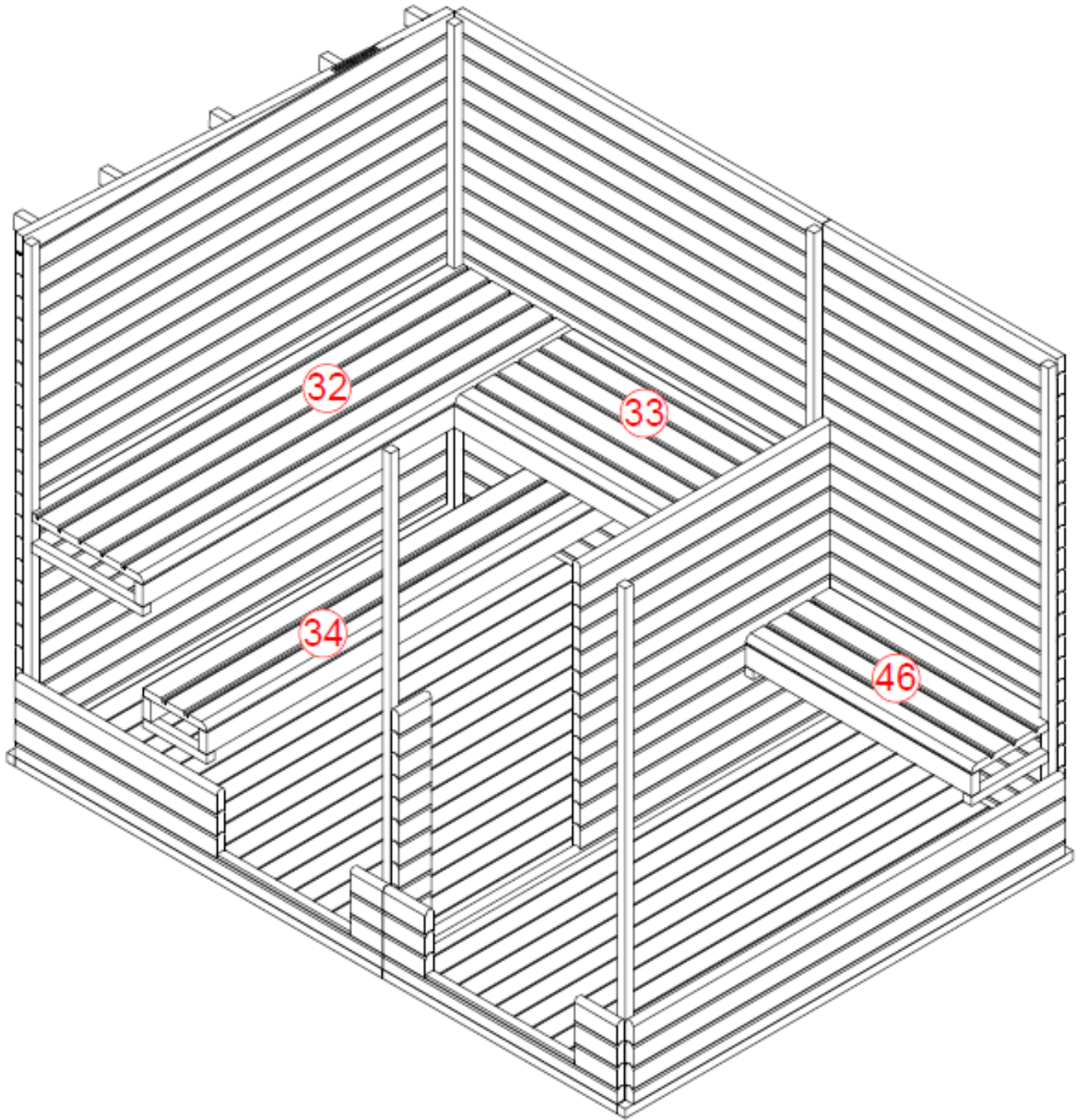

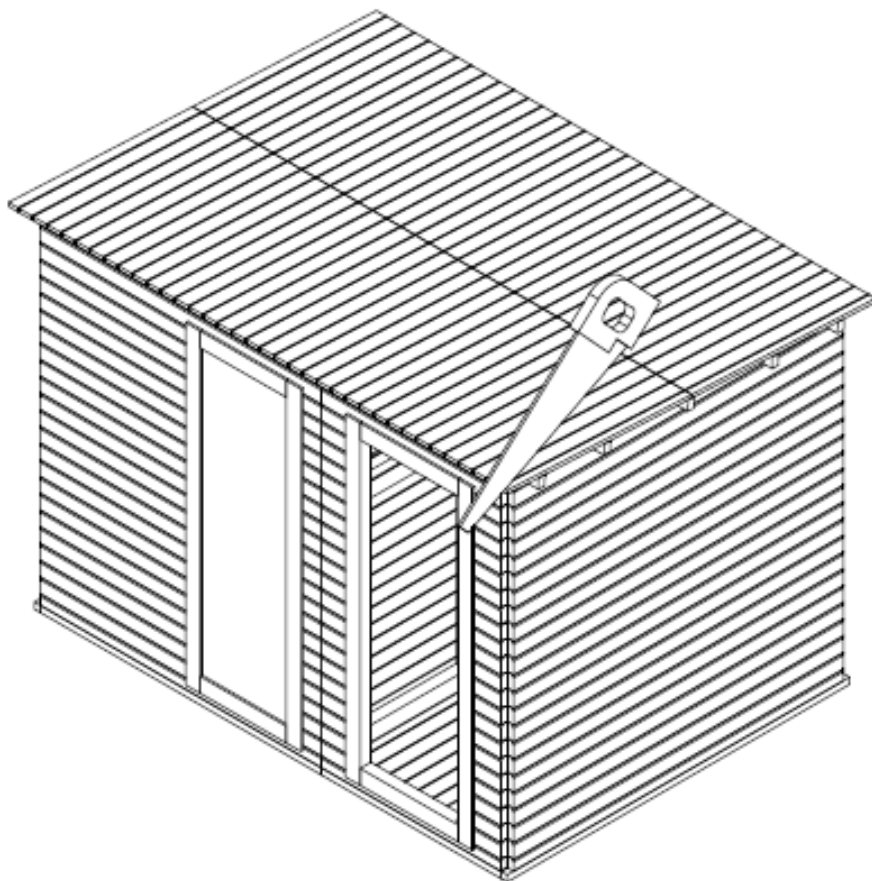
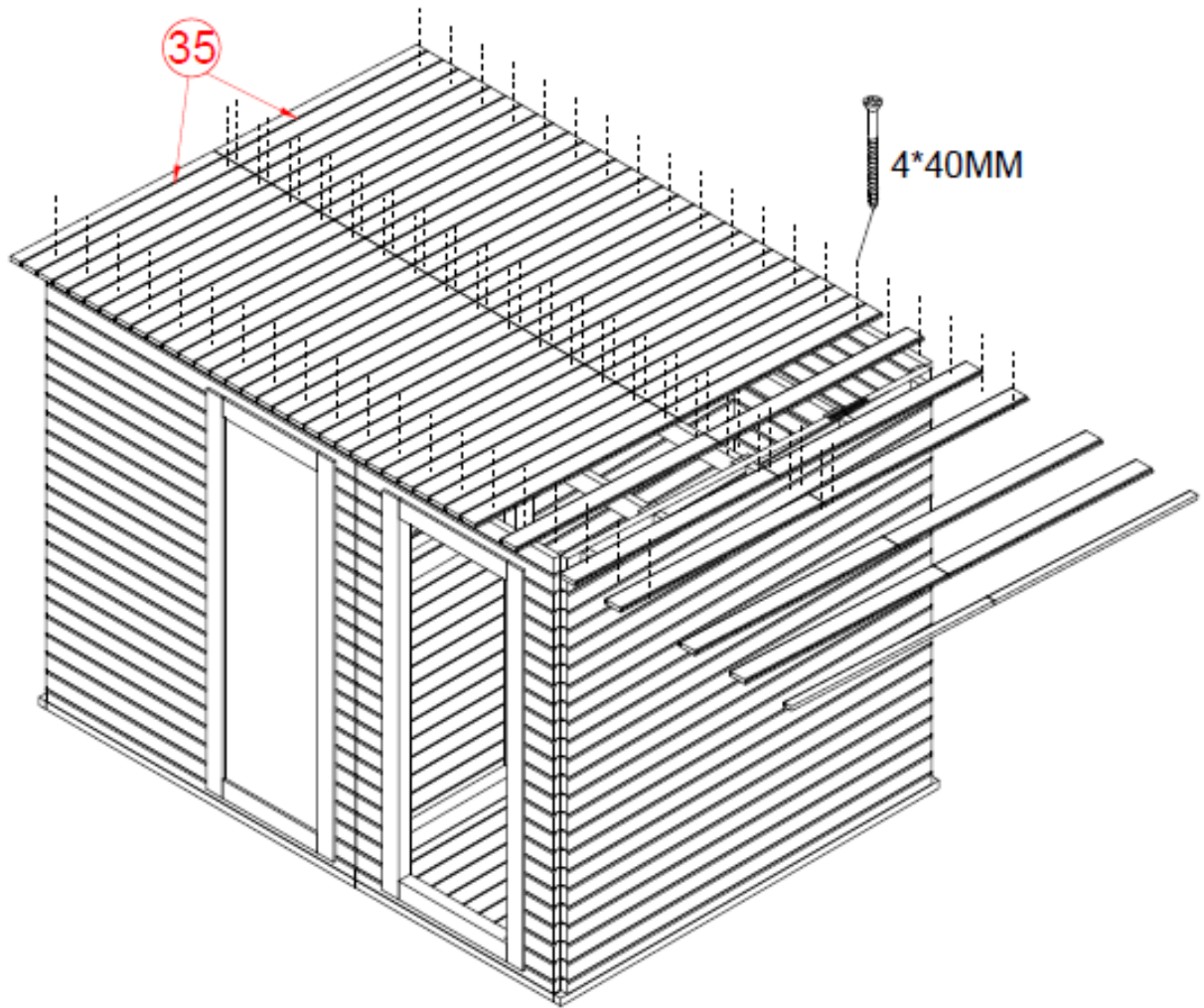

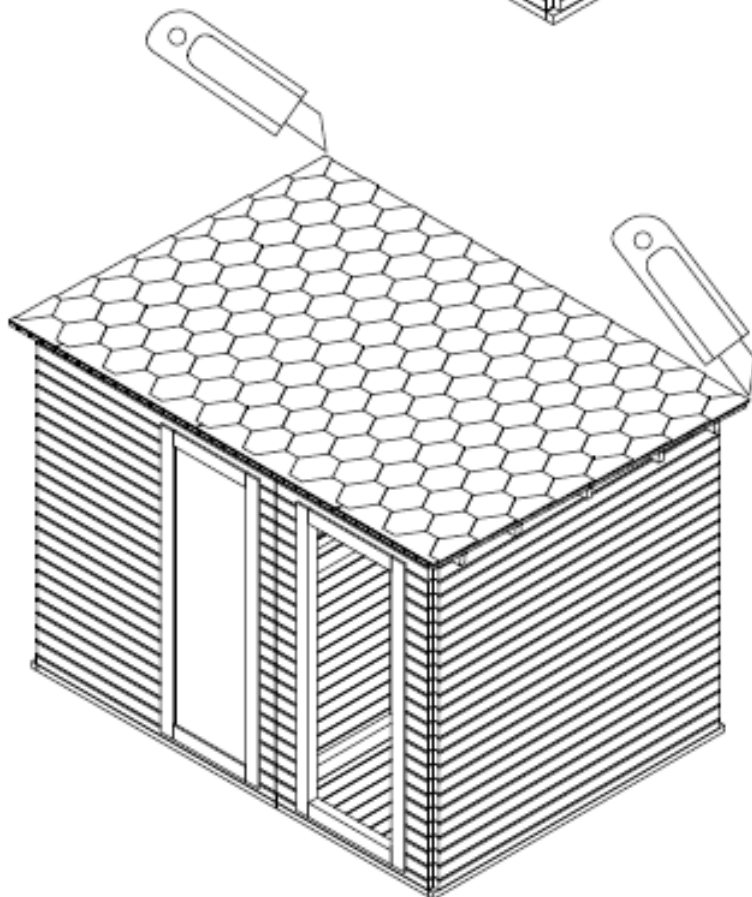
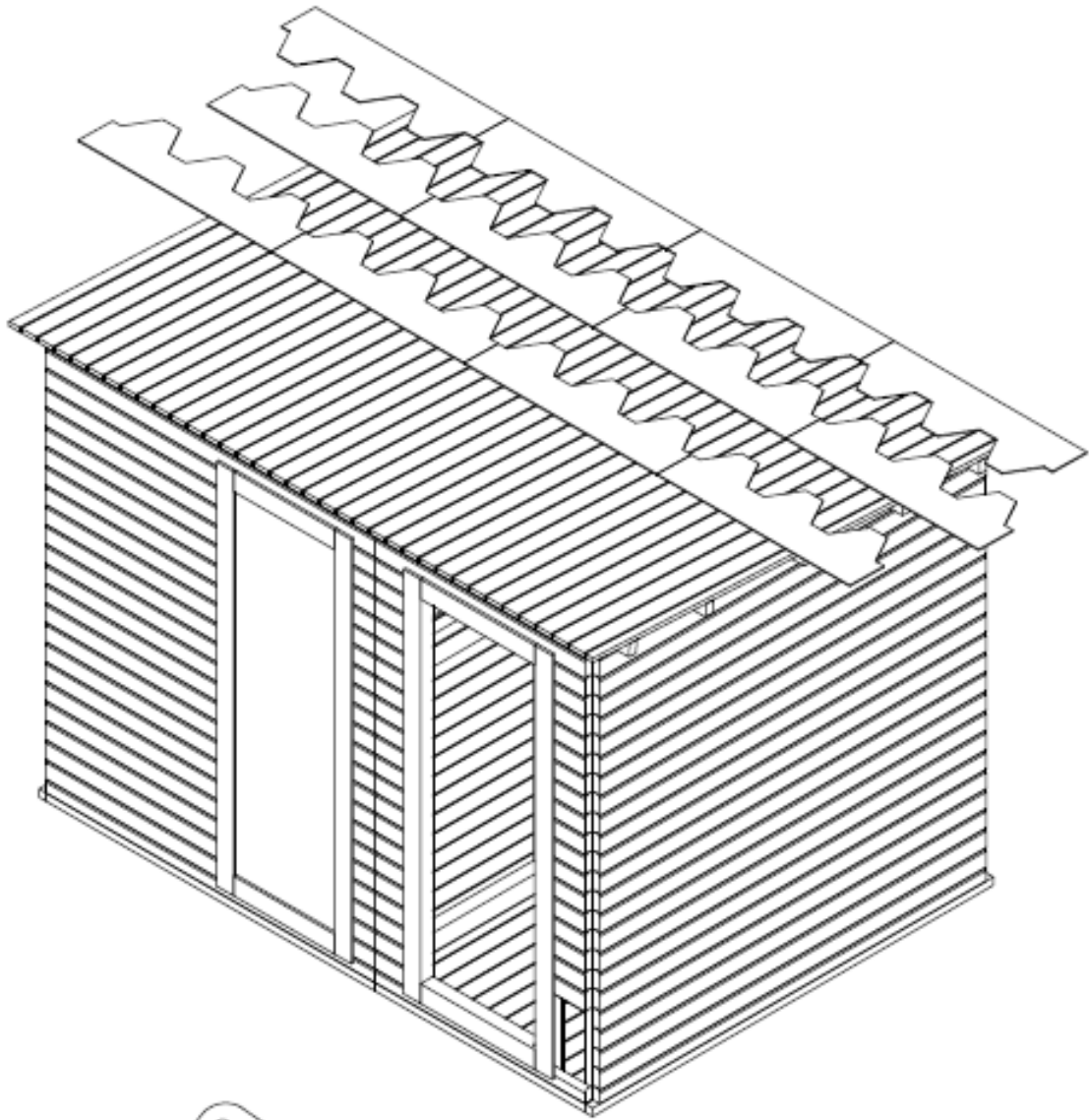

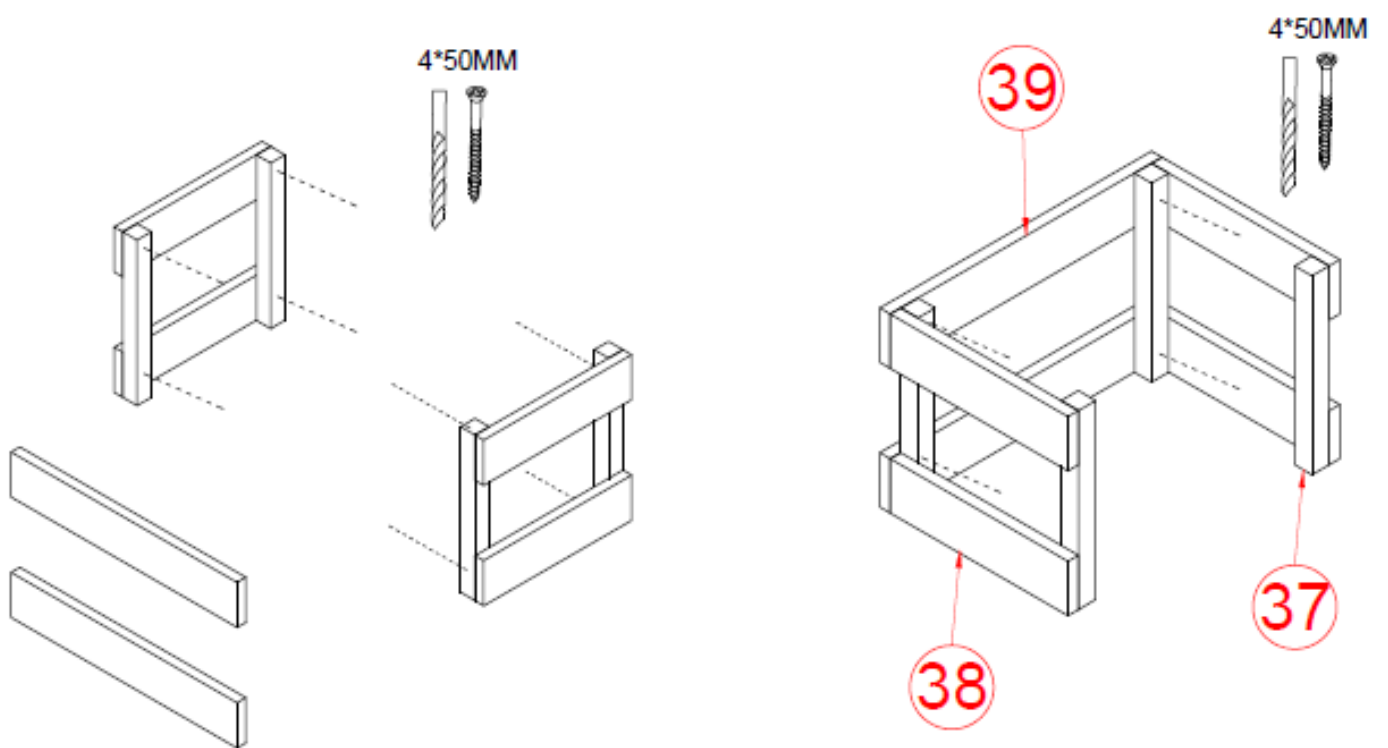
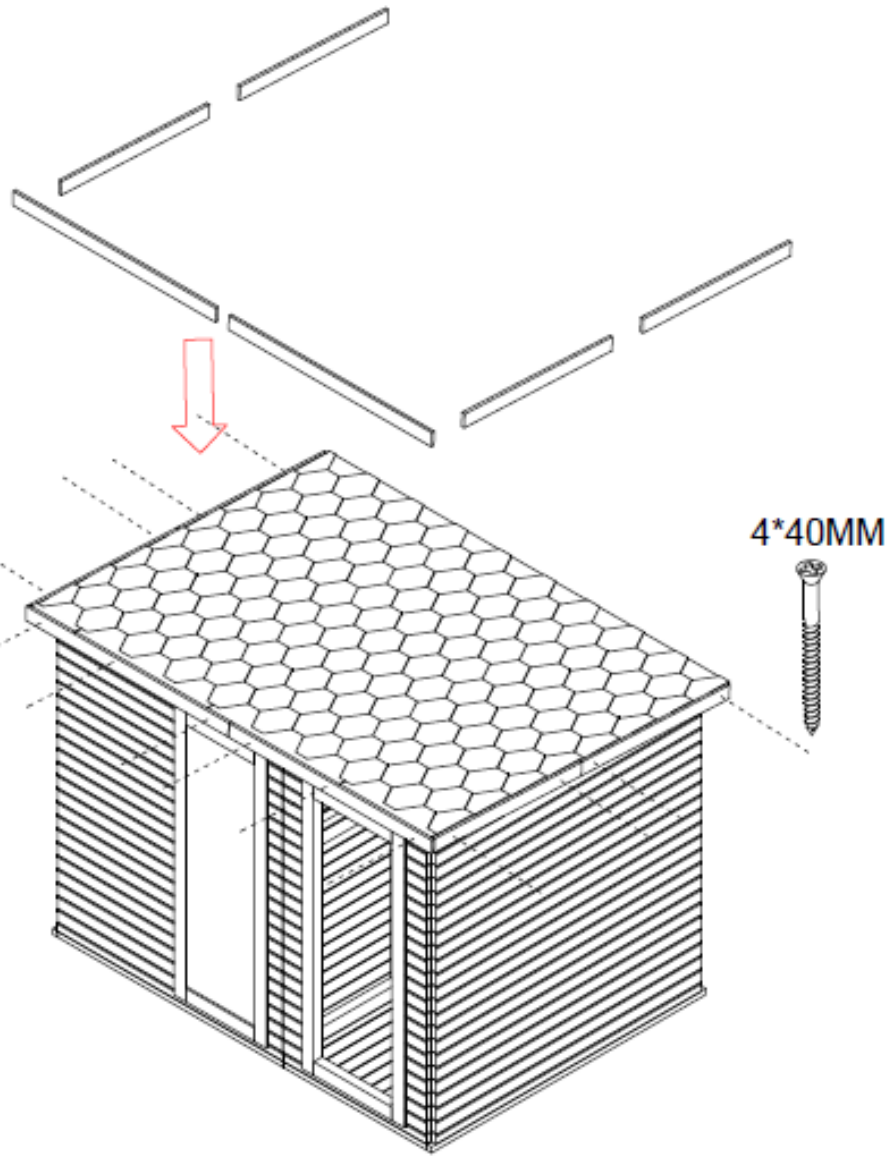

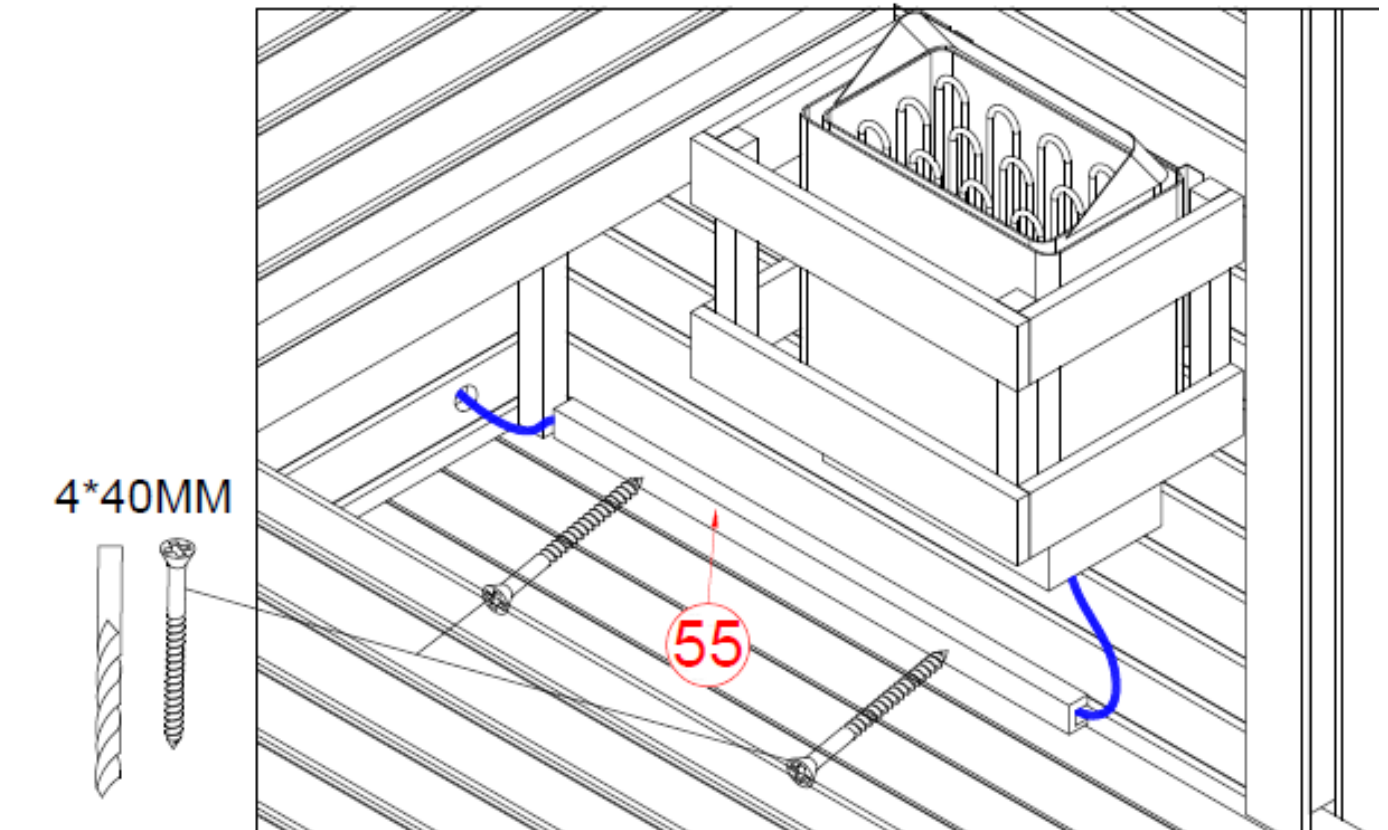
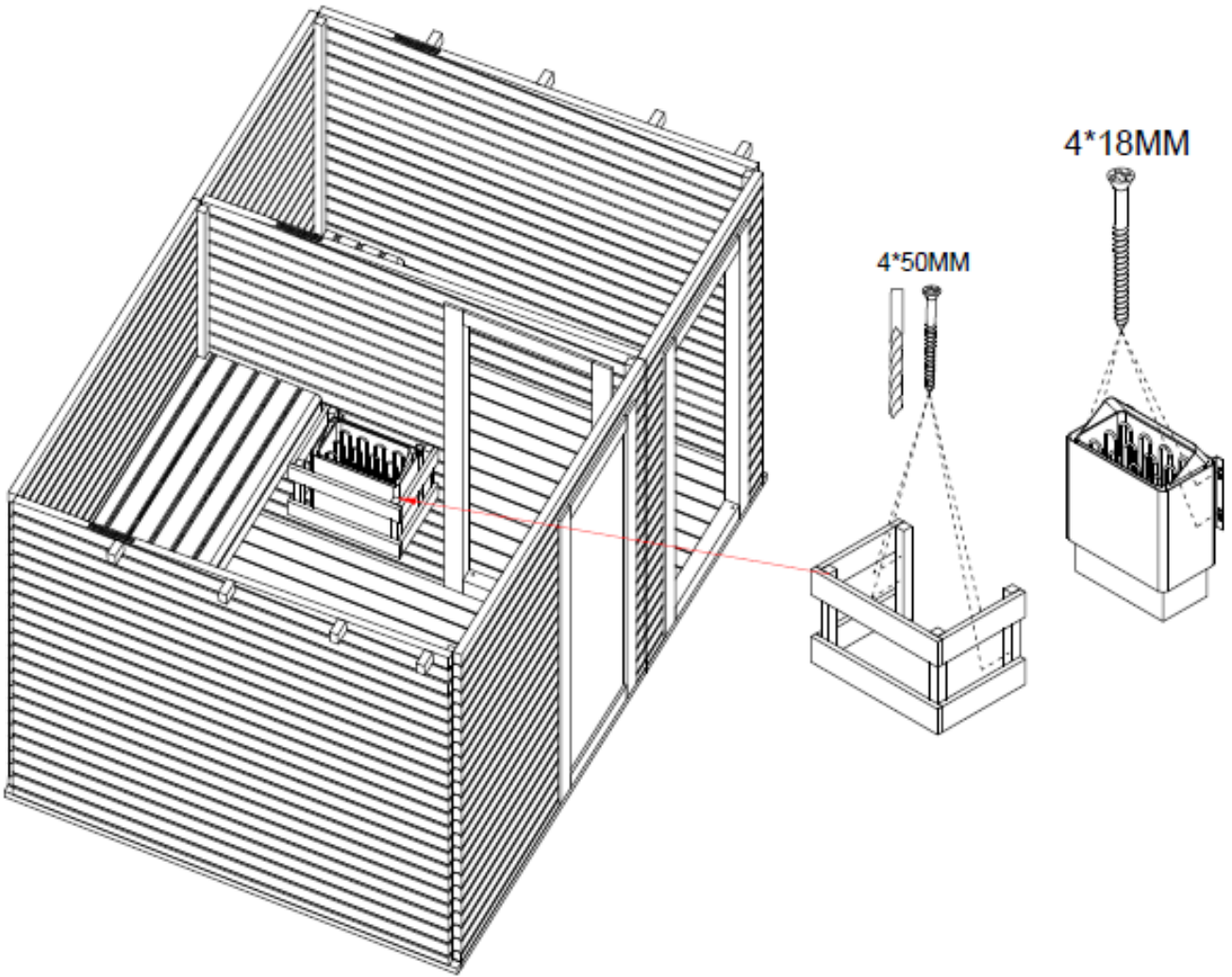

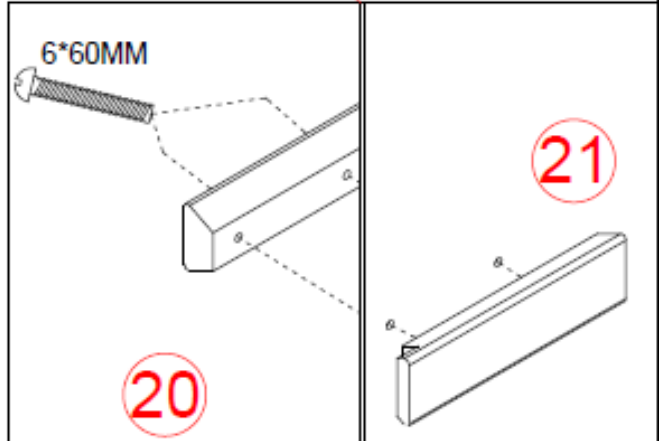
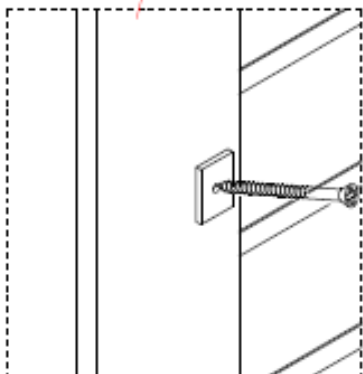
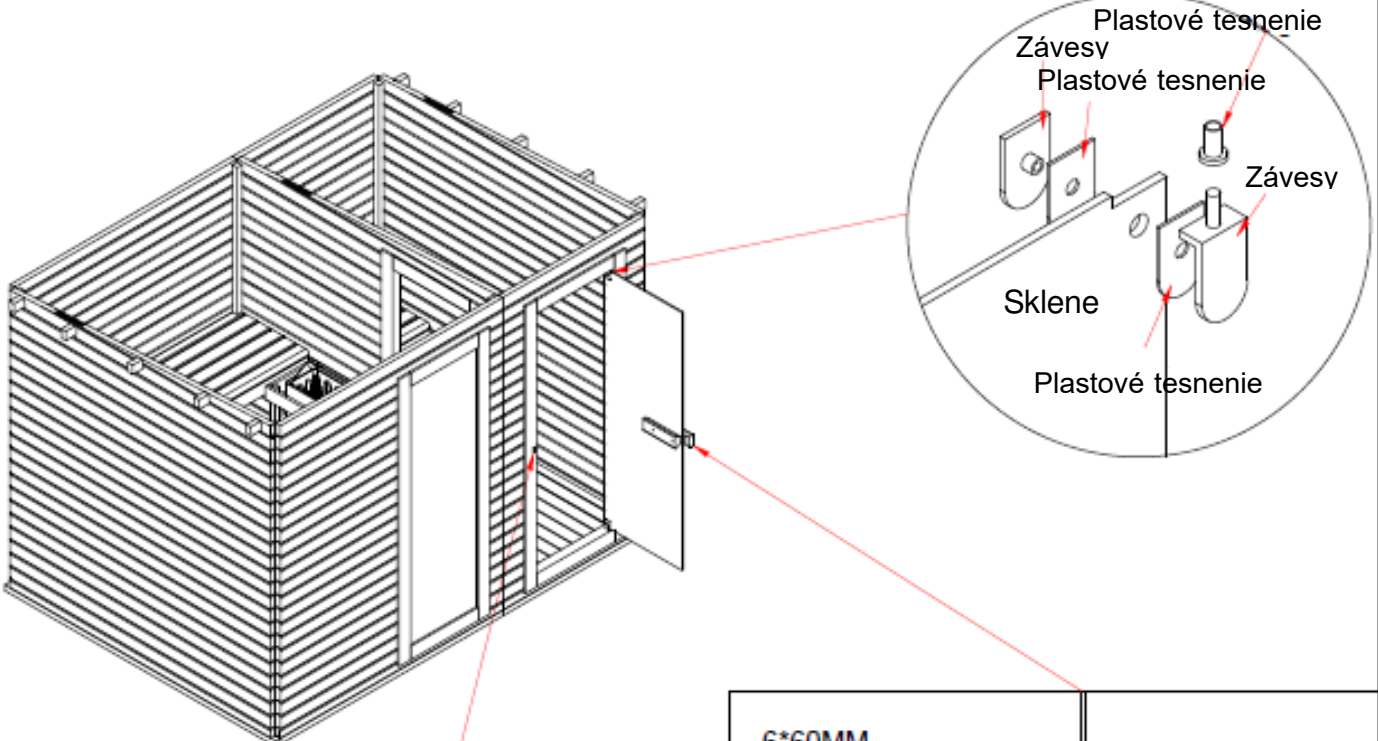
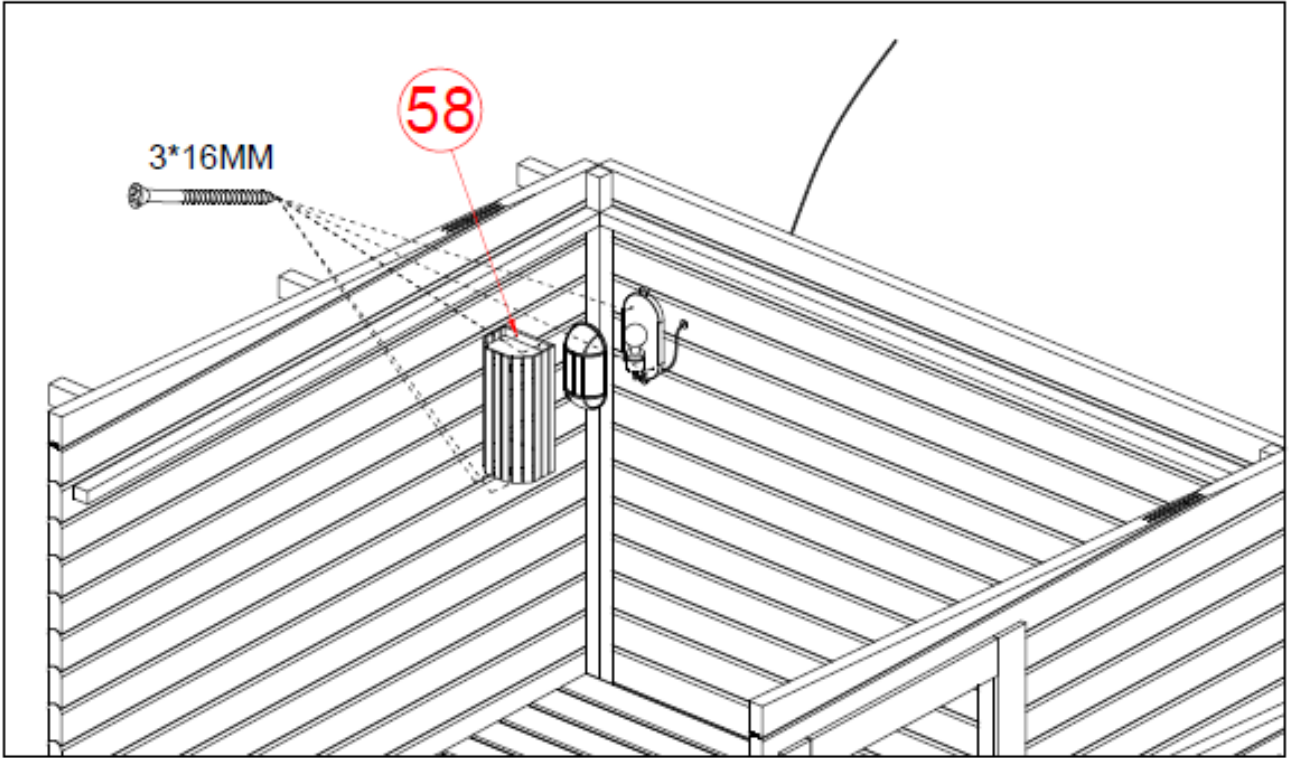

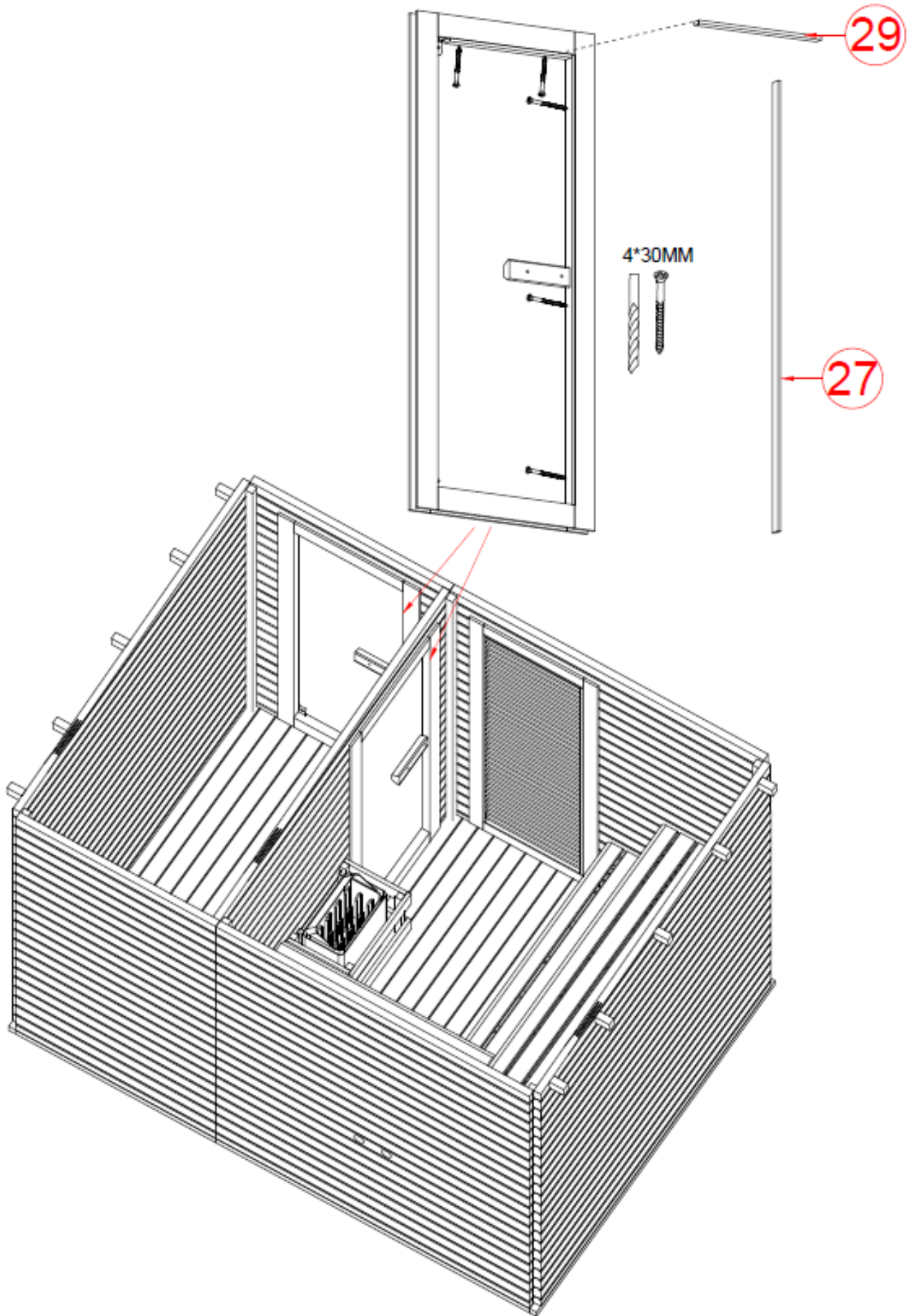

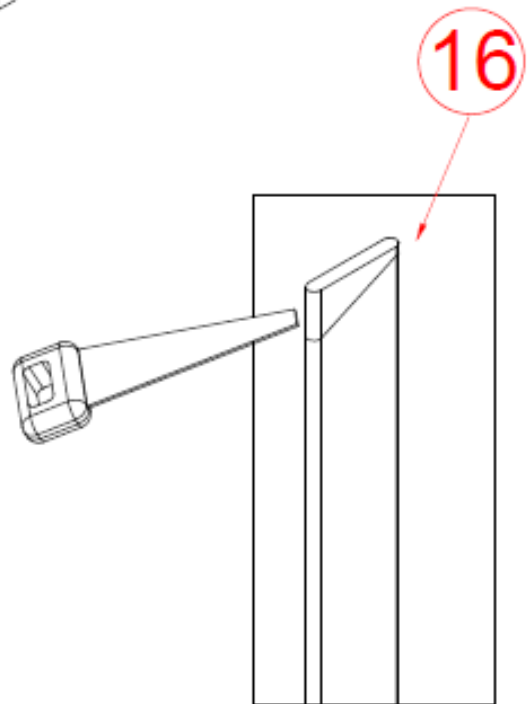
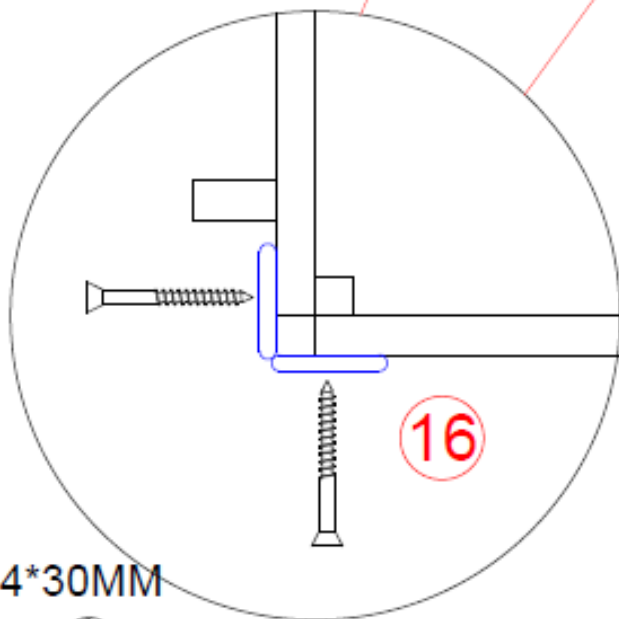
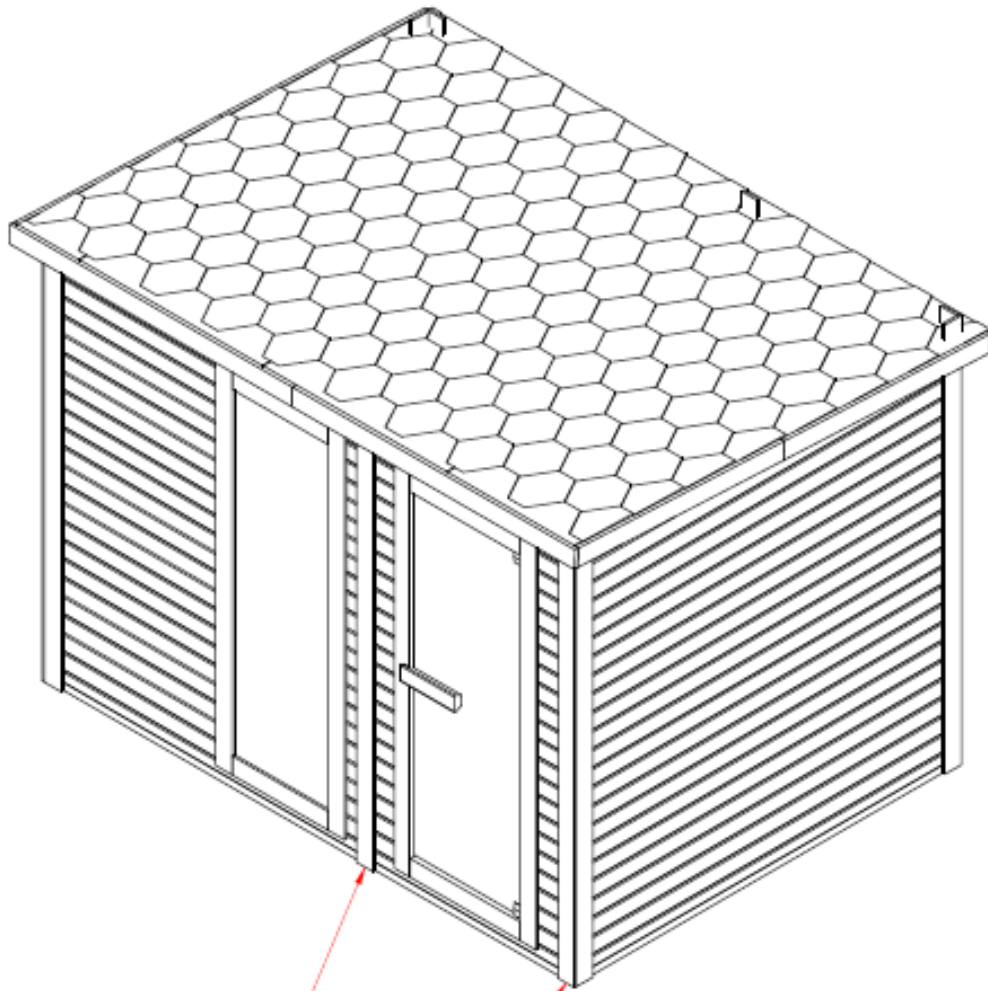

4*30MM

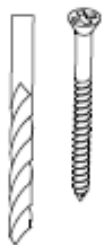

F30310

Návod k použití

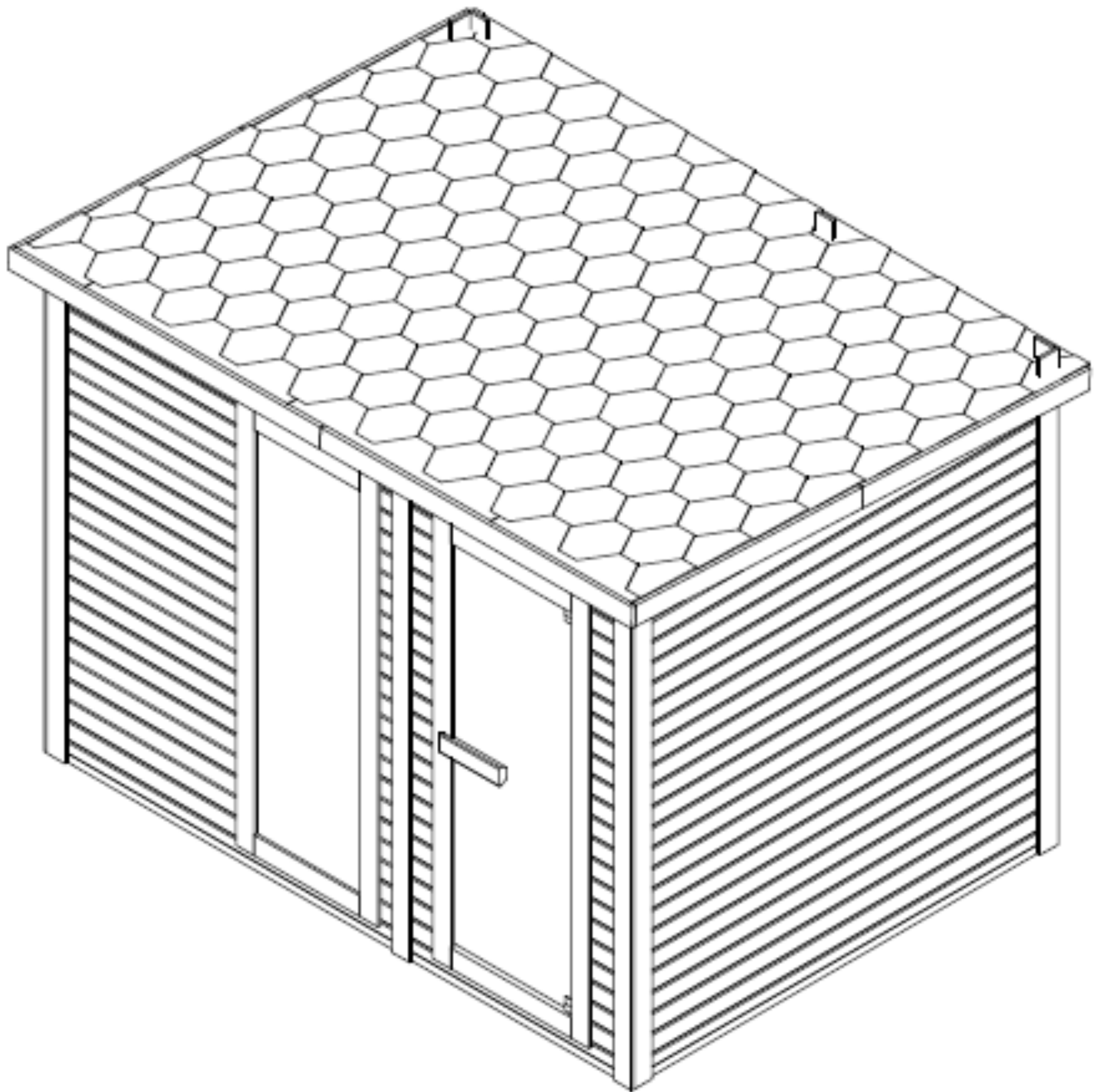

POZORNOST

Před prvním použitím sauny si pozorně přečtěte tuto příručku.

Doporučujeme jej uložit na bezpečném místě, abyste jej mohli v budoucnu znovu použít.

Poznamenejte si prosím sériové číslo ovládací skříňky kabiny, protože toto číslo je vyžadováno v případě opravy nebo objednávky náhradních dílů.

- Dřevo je živý prvek. Pro zachování původního vzhledu je důležité ošetřit vnější stranu dřeva proti vlhkosti.
- Umístěte saunu na dokonale rovný a tvrdý povrch.
- Nepoužívejte tekuté čisticí prostředky. Před čištěním saunu vypněte a použijte reklamovanou tkaninu.
- Chraňte napájecí kabel sauny, aby nedošlo k jeho přiskřípnutí nebo přiskřípnutí.
- Před výměnou určitých součástí se ujistěte, že jsou předepsány výrobcem nebo mají stejné vlastnosti jako originální díly. Nesprávná výměna může způsobit požár, zkrat nebo poškození sauny. Důrazně doporučujeme, abyste zavolali kvalifikovaného technika.
- Abyste předešli riziku popálení nebo úrazu elektrickým proudem, nepoužívejte kovové nástroje.
- Zvířata nemají povolen vstup do sauny.
- Nenechávejte saunu zapnutou bez dozoru.
- Nenechávejte saunu zapnutou déle než 1 hodinu v kuse, aby nedošlo k předčasnému poškození zařízení. Po 1 hodině nepřetržitého používání vypněte saunu alespoň na 30 minut.
- Doporučuje se neinstalovat na dveře sauny uzamykací systém.
- Před připojením sauny k elektrické síti zkontrolujte, zda vaše elektroinstalace splňuje požadavky.
- Montáž a opravy smí provádět pouze kvalifikovaný elektrikář!
- Používejte pouze originální díly.
- Pokud saunu nepoužíváte, vypněte ji.

NEBEZPEČÍ

- Zakrytí kamen vede k riziku požáru v důsledku přehřátí. Nezakrývejte topná tělesa!
- Vždy udržujte hořlavé nebo vysoce hořlavé materiály/předměty (např. ručníky) v dostatečné vzdálenosti od saunových kamen.
- Nedotýkejte se ohříváče během a krátce po použití, protože hrozí nebezpečí popálení horkými částmi.
- Žárovka se během provozu zahřívá. Pokud je třeba žárovku vyměnit, odpojte ji z kabiny a nechte žárovku vychladnout.
- Před výměnou vychladněte.

Bezpečnost

DŮLEŽITÝ!

Před nastavením a používáním saunové kabiny si prosím pečlivě přečtete bezpečnostní pokyny. Upozornění jsou důležitá pro vaši bezpečnost, proto je prosím přísně dodržujte.

Dávejte pozor na hypertermii, úpal nebo vyčerpání z horka, které mohou být způsobeny nebo zhoršeny nedodržením bezpečnostních pokynů. Mezi příznaky patří horečka, zrychlený puls, závratě, mdloby, letargie a necitlivost v celém těle nebo částech těla. Účinky jsou: snížené vnímání horka, nevědomost o hrozícím nebezpečí, ztráta vědomí.

Saunu nesmějí využívat:

- Děti do 6 let.
- Lidé se silnými reakcemi na sluneční světlo.
- Lidé s již existujícími onemocněními, jako je srdeční onemocnění, vysoký nebo nízký krevní tlak, poruchy krevního oběhu nebo cukrovka bez předchozí lékařské pomoci.
- Těhotné ženy. Nadměrná teplota může ohrozit plod.
- Lidé, kteří trpí dehydratací, otevřenými ranami, očními chorobami, popáleninami nebo úpalem.

Děti ve věku od 6 do 16 let mohou saunu používat za předpokladu, že jsou pod neustálým dohledem odpovědné dospělé osoby a teplota nepřesáhne 60 °C.

V případě zdravotních problémů, užívání léků nebo poranění svalů a vazů je vstup do sauny povolen pouze po předchozí konzultaci s lékařem a jeho souhlasu.

Pokud máte chirurgické implantáty, nesmíte saunu používat bez předchozí konzultace s lékařem a získání jeho souhlasu.

Saunu nepoužívejte po namáhavých aktivitách.

Počkejte 30 minut, než se vaše tělo ochladí.

V sauně nezůstávejte déle než 40 minut v kuse.

Nekonzumujte alkohol ani drogy před nebo během sezení.

Nespěte v sauně, když je v provozu.

Abyste předešli riziku přehřátí, zapojte saunu do dostatečně výkonné zásuvky a do stejné zásuvky nepřipojujte další elektrické spotřebiče.

Aby se předešlo riziku úrazu elektrickým proudem nebo poškození sauny, nesmí se používat:

- Během bouřky.
- Pokud je elektrický kabel poškozen, musí být vyměněn kvalifikovanou osobou.
- Pokud se napájecí kabel přehřívá, musí jej zkontrolovat kvalifikovaná osoba.
- Pokud potřebujete vyměnit žárovku, počkejte, až se sauna vypne a vychladne.

Před zapojením nebo vypnutím napájení si osušte ruce.

Nikdy nepracujte mokřima rukama nebo nohama.

Nezapínejte nebo nevypínejte napájení nebo topení rychle, protože by mohlo dojít k poškození elektrického systému.

Nepokoušejte se saunu opravit sami bez souhlasu prodejce sauny nebo výrobce.

Neoprávněné pokusy o opravu způsobí ztrátu záruky výrobce.

V sauně nepoužívejte čisticí prostředky.

Neskládejte ani neskladujte předměty v sauně ani na ní.

V blízkosti sauny neumísťujte hořlavé materiály ani chemické látky.

Nezakrývejte topná tělesa!





Nedotýkejte se ohříváče během a krátce po použití, protože hrozí nebezpečí popálení horkými částmi.



Pokud kabinu nepoužíváte, vypněte ji.

Specifikace:

Model	F30310 řekl:
Materiál kabiny	Smrk
Hloubka	2300 mm
Šířka	3100 mm
Výška	2200 mm
Napětí	AC380V
Ohříváč	8KW

Montážní materiál (možné odchylky)

											
Ø3x16	Ø4x70	Ø4x60	Ø4x50	Ø4*40	Ø4*30	Ø4*18	Ø5*100	Ø6x60	Wood pad		
6x	103x	300x	76x	240x	62x	40x	2x	4x	2x	2x	4x

		
2x	10x	2x

Před zahájením montáže odstraňte přepravní obal a zkontrolujte, zda byla vaše infrakabina dodána kompletní a neporušená.

Před nalezením vhodného místa pro vaši saunu si pečlivě přečtěte montážní návod.

Sauna je určena výhradně pro venkovní instalaci.

Vyberte oblast:

- Na suchém místě na rovném, stabilním povrchu, který unese váhu vaší sauny.
- Výška musí být dostatečná, abyste mohli dosáhnout na strop a provádět elektrické připojení a údržbu.
- Uchovávejte mimo dosah vodních zdrojů, plamenů nebo hořlavých materiálů.
- Požadovaná minimální výška místnosti je 2,02 m

Praktické rady

- Vezměte prosím na vědomí, že k vybavení sauny jsou nutné alespoň 2 dospělé osoby.
- Než začnete, jednoznačně identifikujte každý panel
- Při instalaci položte napájecí kabel vaší sauny tak, aby byl snadno přístupný.
- Všimněte si, že mezi modely existují rozdíly.

DŮLEŽITÝ:





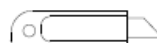
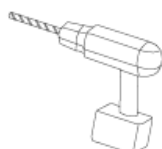
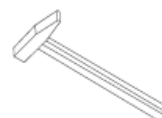
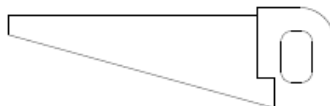
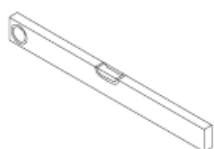



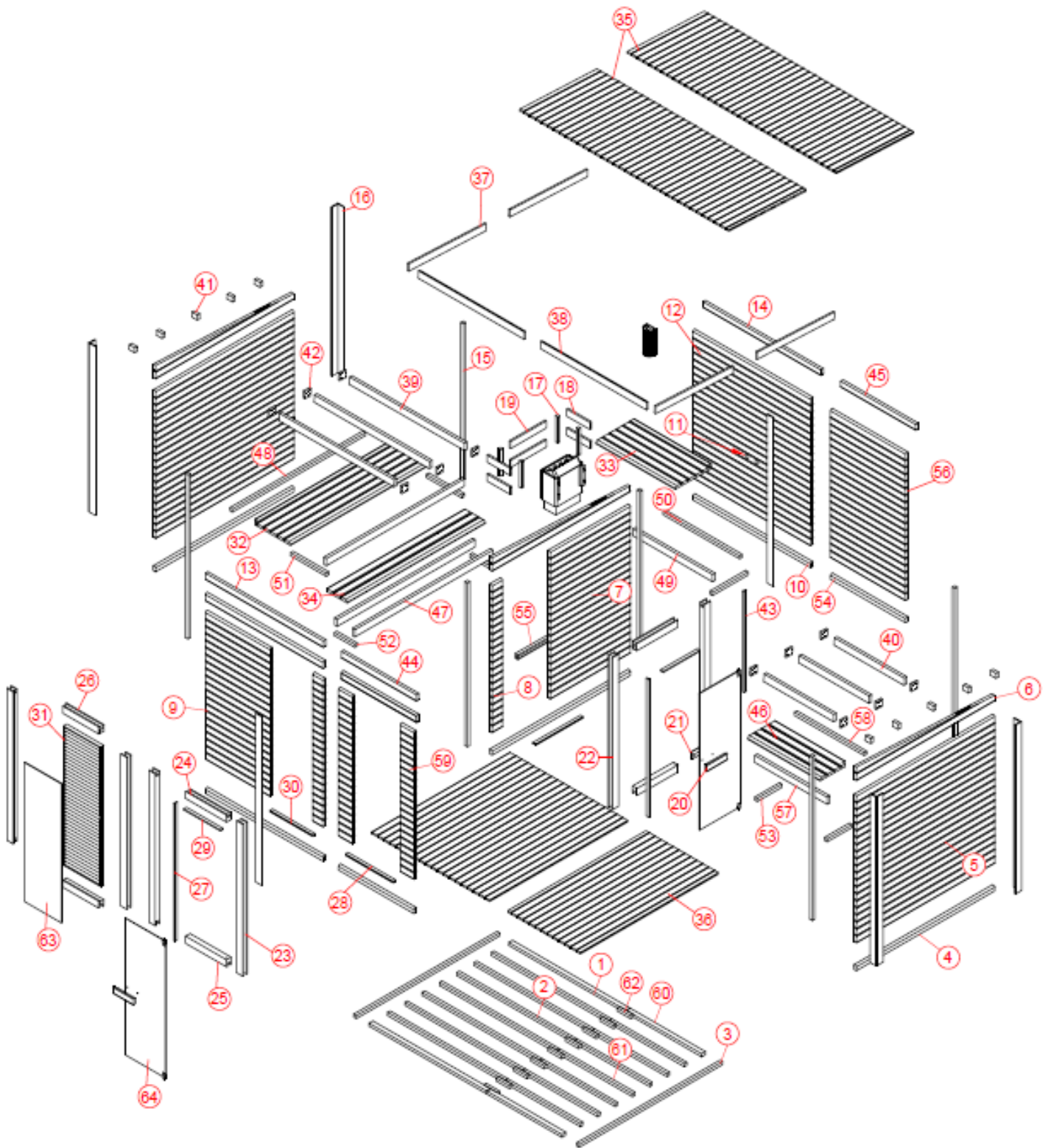

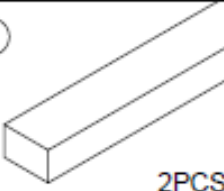
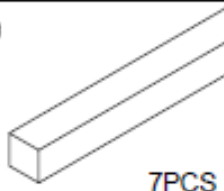
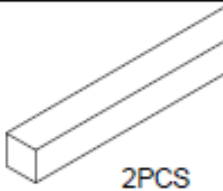
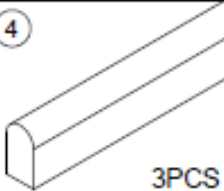
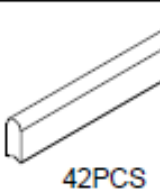

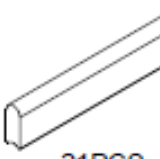

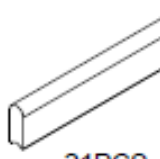
Zkontrolujte prosím zhloubení a průměr otvorů vyvrtaných otvorů, aby nedošlo k poškození dřeva.

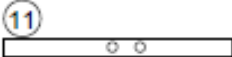
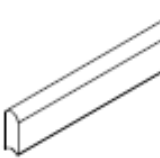
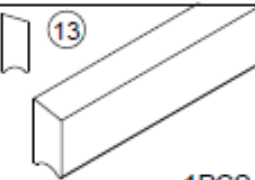
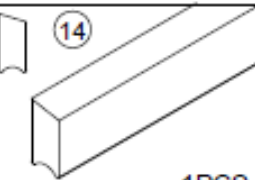
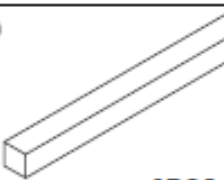
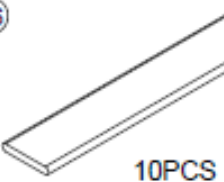
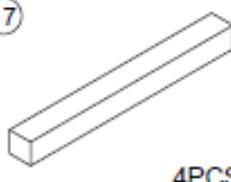
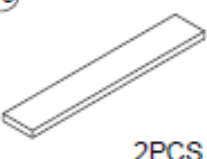
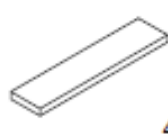
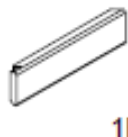
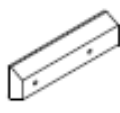
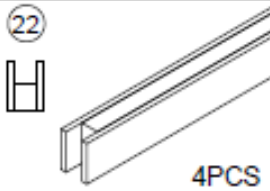
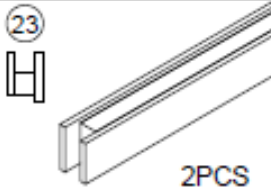
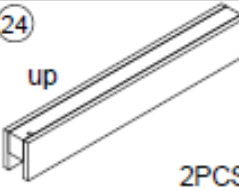

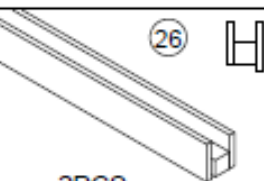
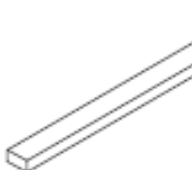
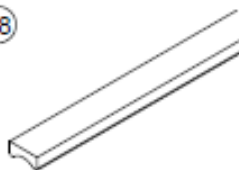

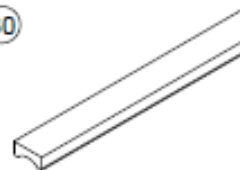

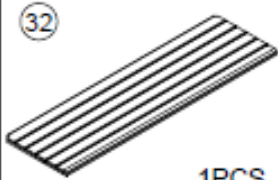
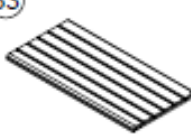

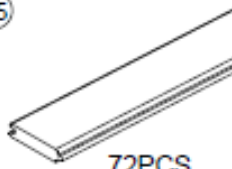
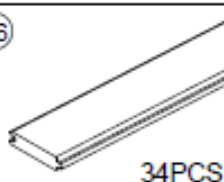
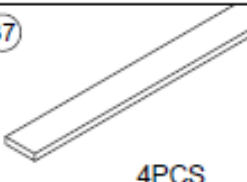
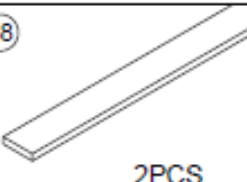
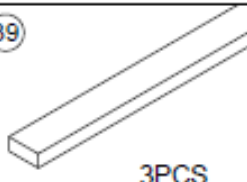
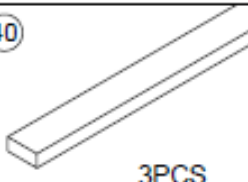



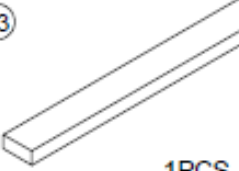

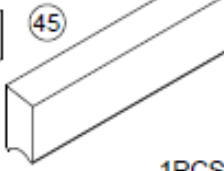
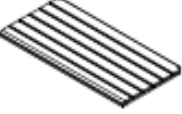
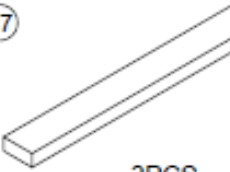
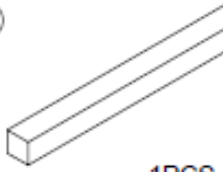
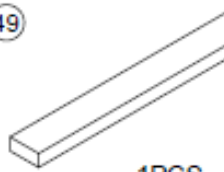
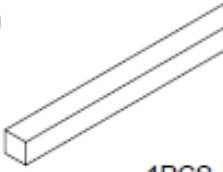
Nářadí:

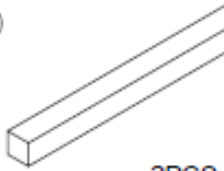
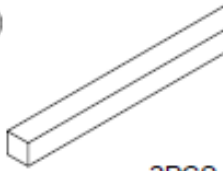

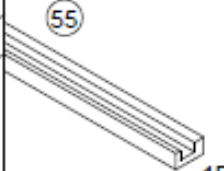
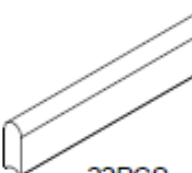
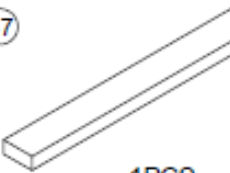
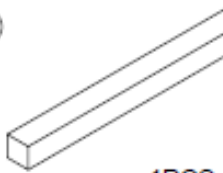
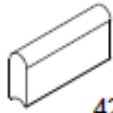
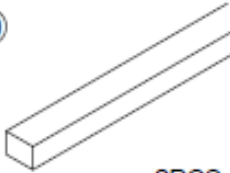
Kusovník:

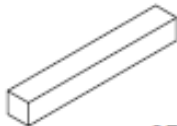
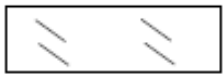
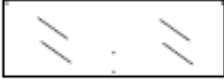

①  2PCS 1724*55*38mm	②  7PCS 1724*38*38mm	③  2PCS 2100*38*38mm	④  3PCS 2024*67*38mm	⑤  42PCS 2024*97*38mm
⑥  3PCS 2024*168*38mm	⑦  21PCS 1172*97*38mm	⑧  42PCS 150*97*38mm	⑨  21PCS 945*97*38mm	⑩  2PCS 1724*67*38mm
⑪  1PCS 1724*97*38mm	⑫  21PCS 1724*97*38mm	⑬  1PCS 1724*81*38mm	⑭  1PCS 1724*70*38mm	⑮  6PCS 2188*38*38mm
⑯  10PCS 2140*90*13mm	⑰  4PCS 330*33*33mm	⑱  2PCS 520*90*20mm	⑲  4PCS 340*90*20mm	⑳  1PCS 300*90*40mm
㉑  1PCS 252*90*40mm	㉒  4PCS 1927*90*66mm	㉓  2PCS 1927*90*66mm	㉔  2PCS 600*90*66mm	㉕  2PCS 600*90*66mm
㉖  2PCS 547*90*66mm	㉗  2PCS 1747*40*13mm	㉘  2PCS 700*38*17mm	㉙  2PCS 537*40*13mm	㉚  1PCS 627*38*17mm
㉛  1PCS 1765*545*47mm	㉜  1PCS 2022*560*33mm	㉝  1PCS 1162*560*33mm	㉞  1PCS 2022*300*33mm	㉟  72PCS 1130*97*18mm
㊳  34PCS 2022*97*18mm	㊴  4PCS 1132*90*20mm	㊵  2PCS 1552*90*20mm	㊶  3PCS 1684*90*38mm	㊷  3PCS 1022*90*38mm

 10PCS 80*60*38mm	 12PCS 90*90*20mm	 1PCS 1550*33*13mm	 1PCS 1100*81*38mm	 1PCS 1100*70*38mm
 1PCS 1060*400*33mm	 3PCS 2022*90*38mm	 1PCS 1946*38*38mm	 1PCS 1162*90*38mm	 1PCS 1124*38*38mm
 3PCS 522*38*38mm	 2PCS 300*38*38mm	 2PCS 362*38*38mm	 2PCS 1100*67*38mm	 1PCS 820*40*20mm
 22PCS 1100*97*38mm	 1PCS 1060*90*38mm	 1PCS 1022*38*38mm	 42PCS 198*97*38mm	 2PCS 1100*55*38mm
 7PCS 1100*38*38mm	 9PCS 200*38*38mm	 1PCS 1764*544*6mm	 1PCS 1733*594*6mm	 1PCS 300*142*105MM
 Sauna light	 Sauna stove	 69PCS 1000*320*5mm		

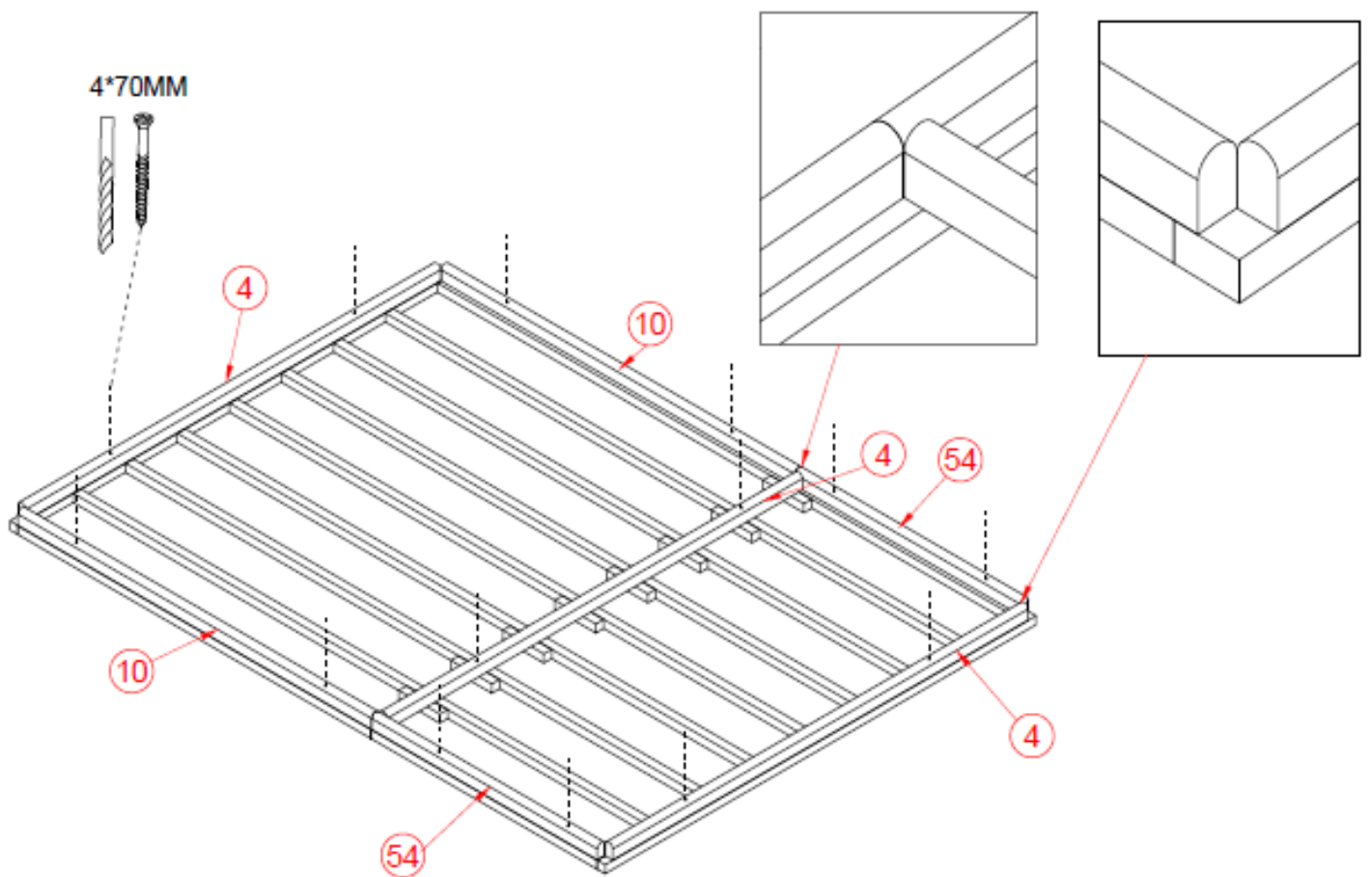
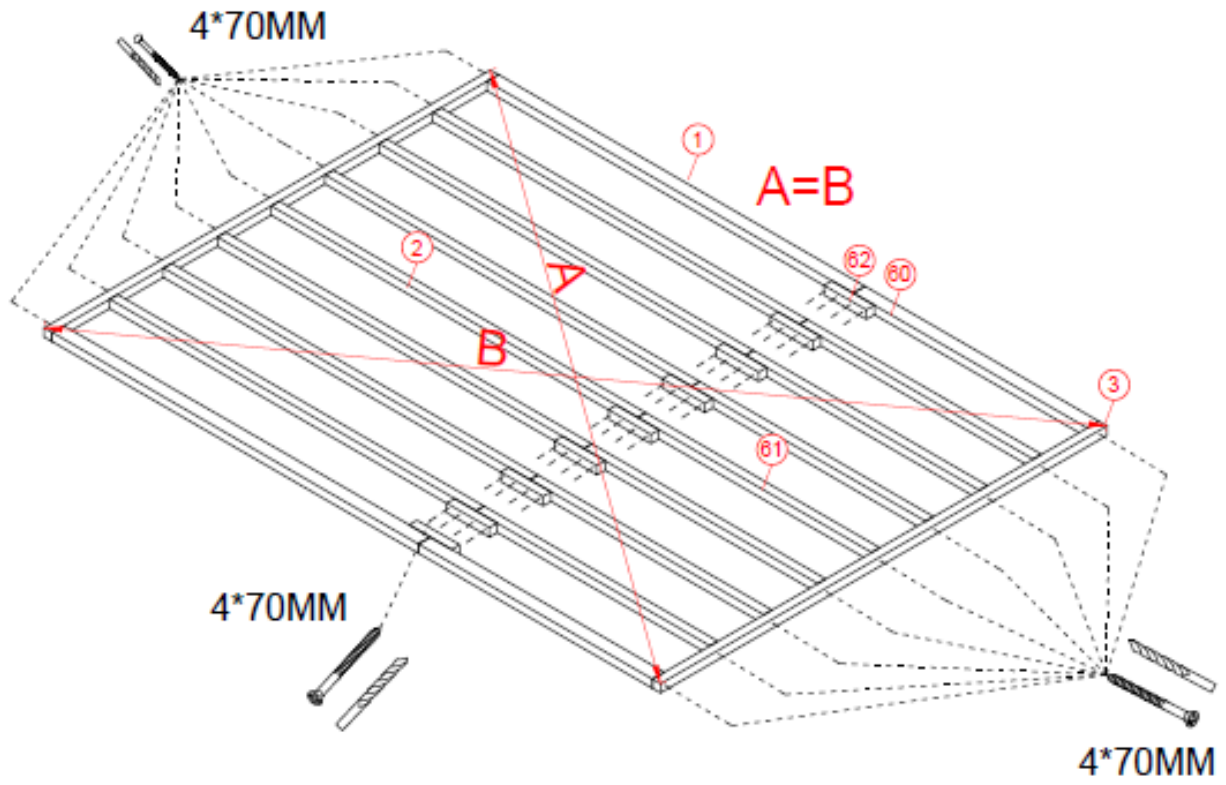

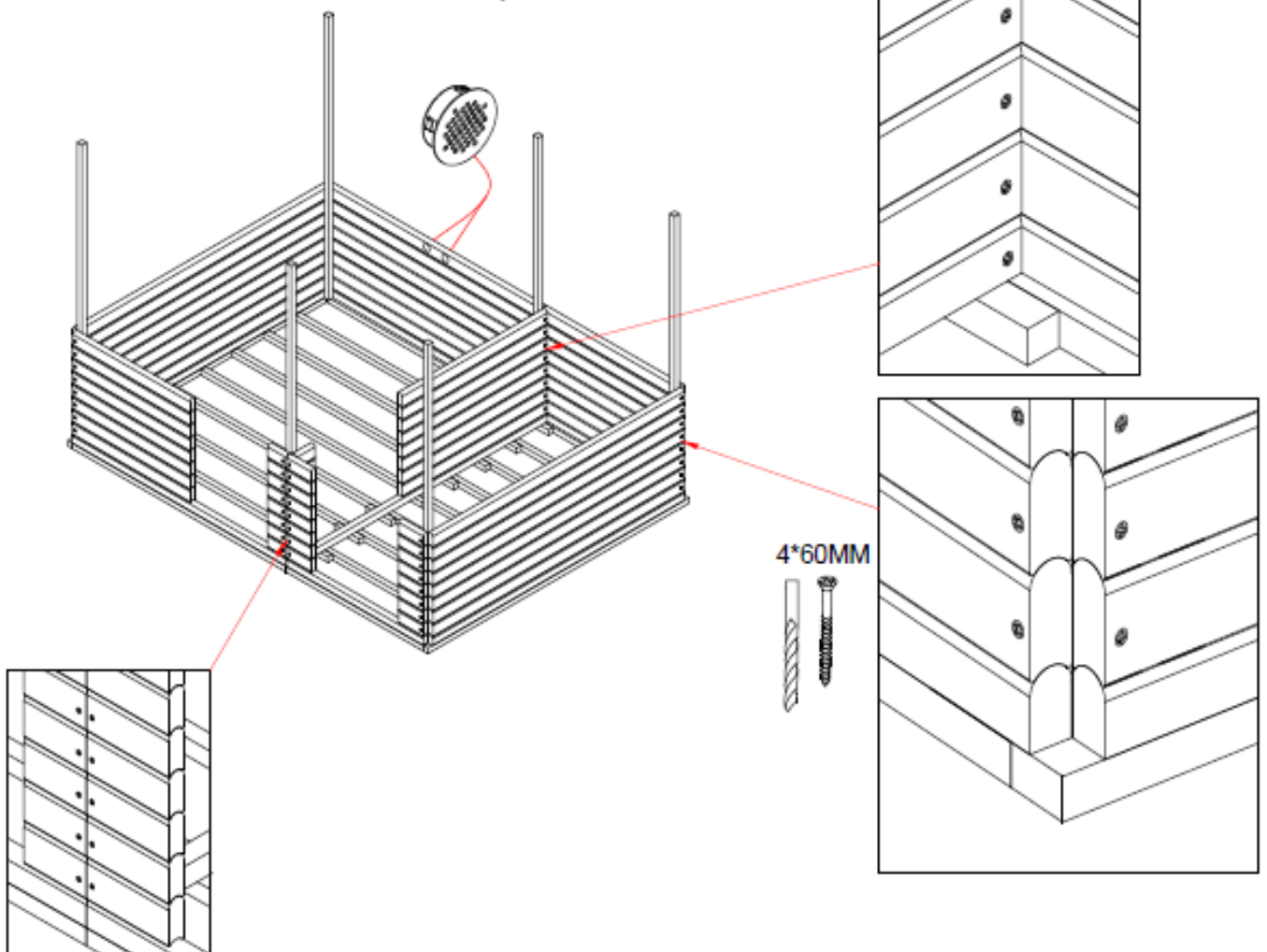
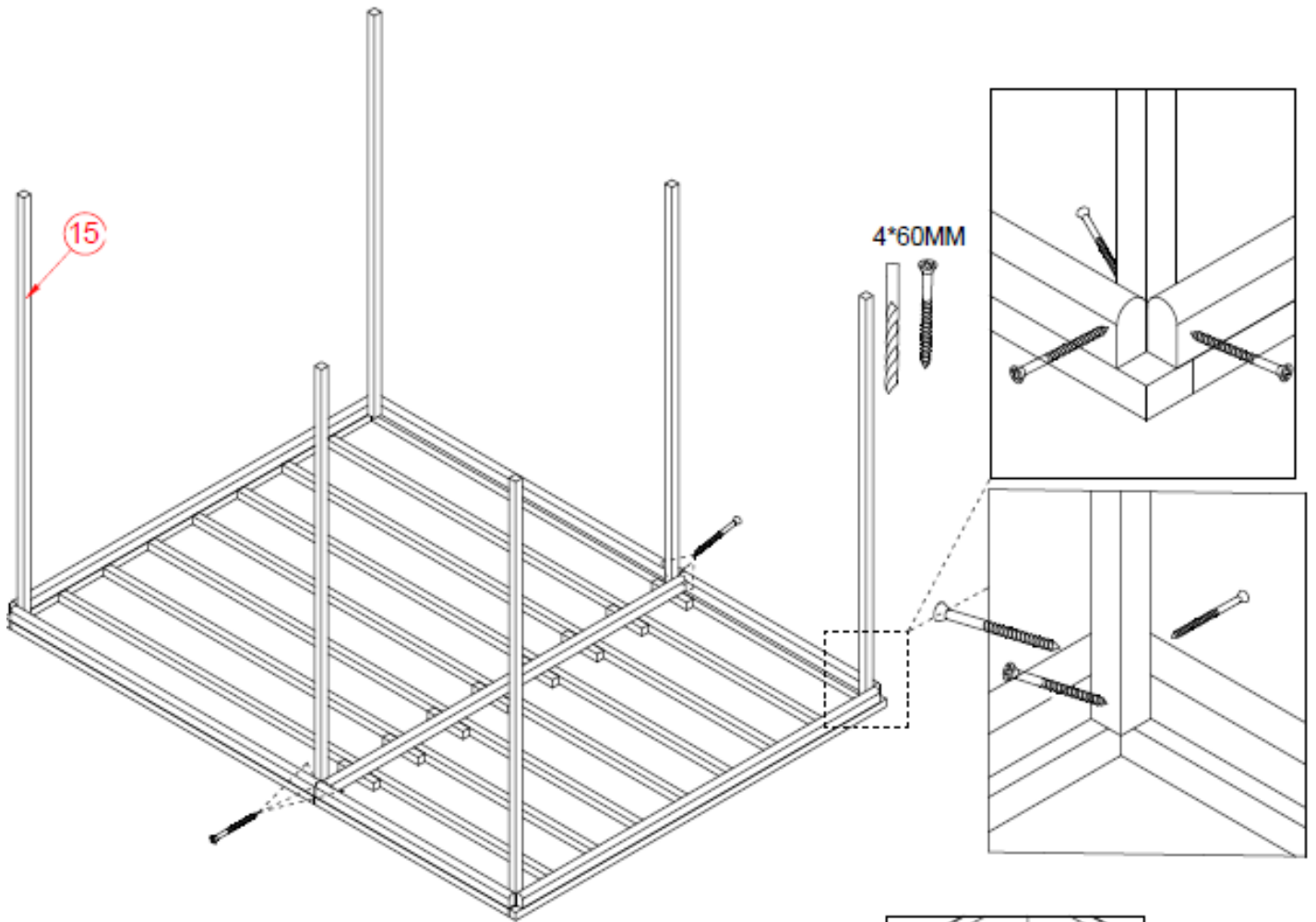

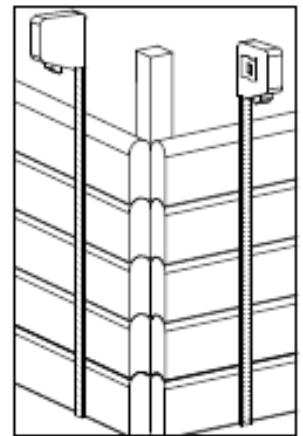
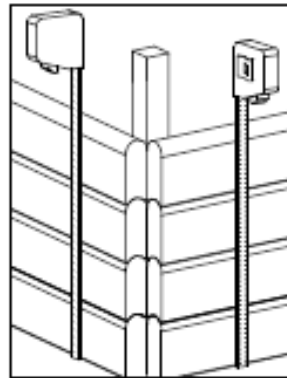
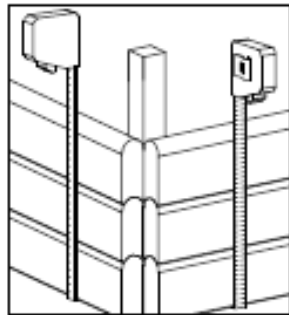
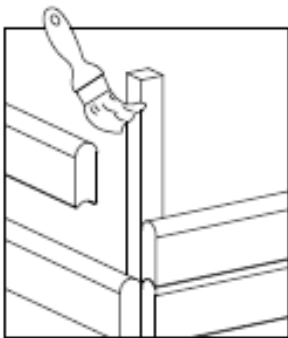
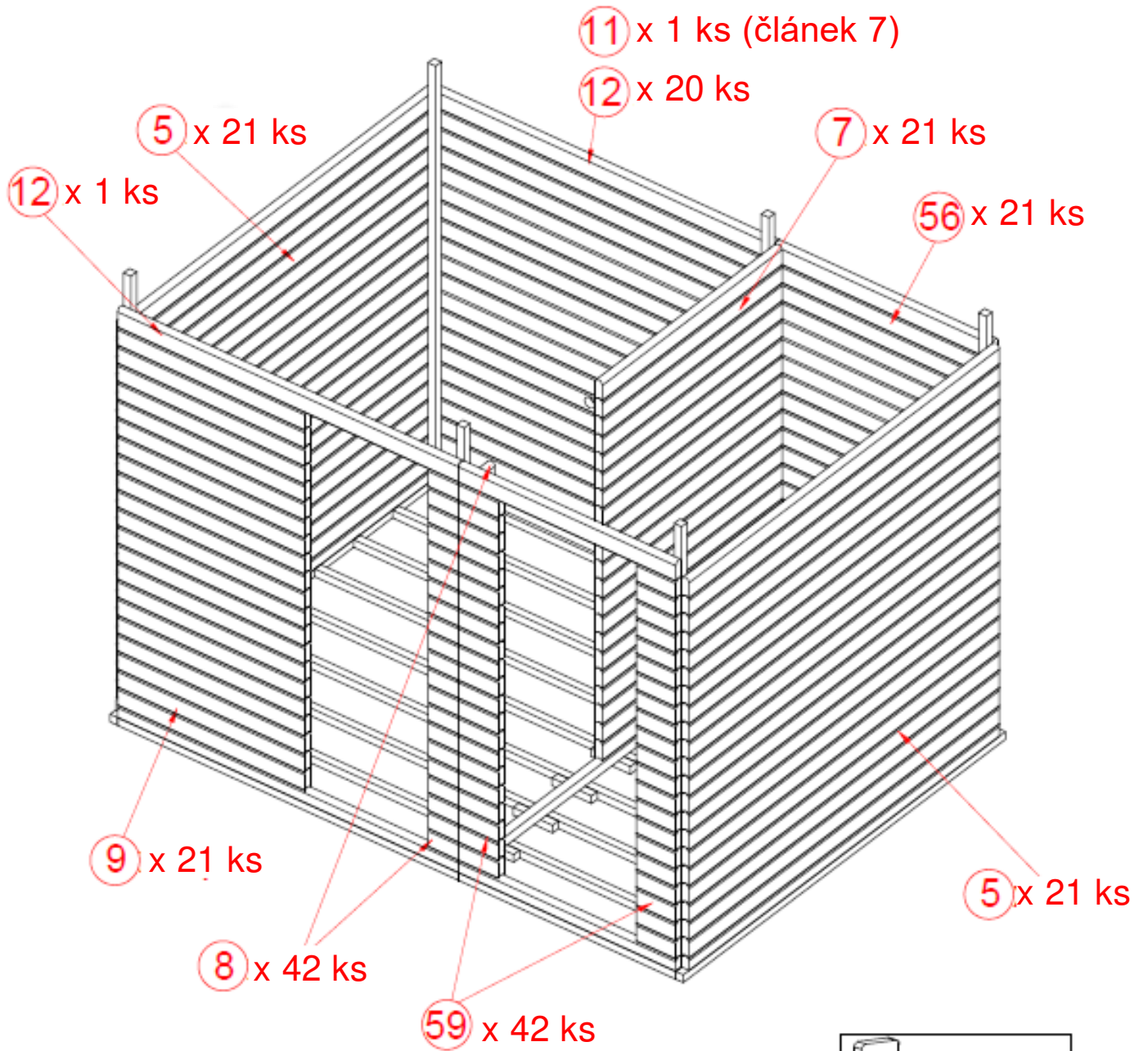

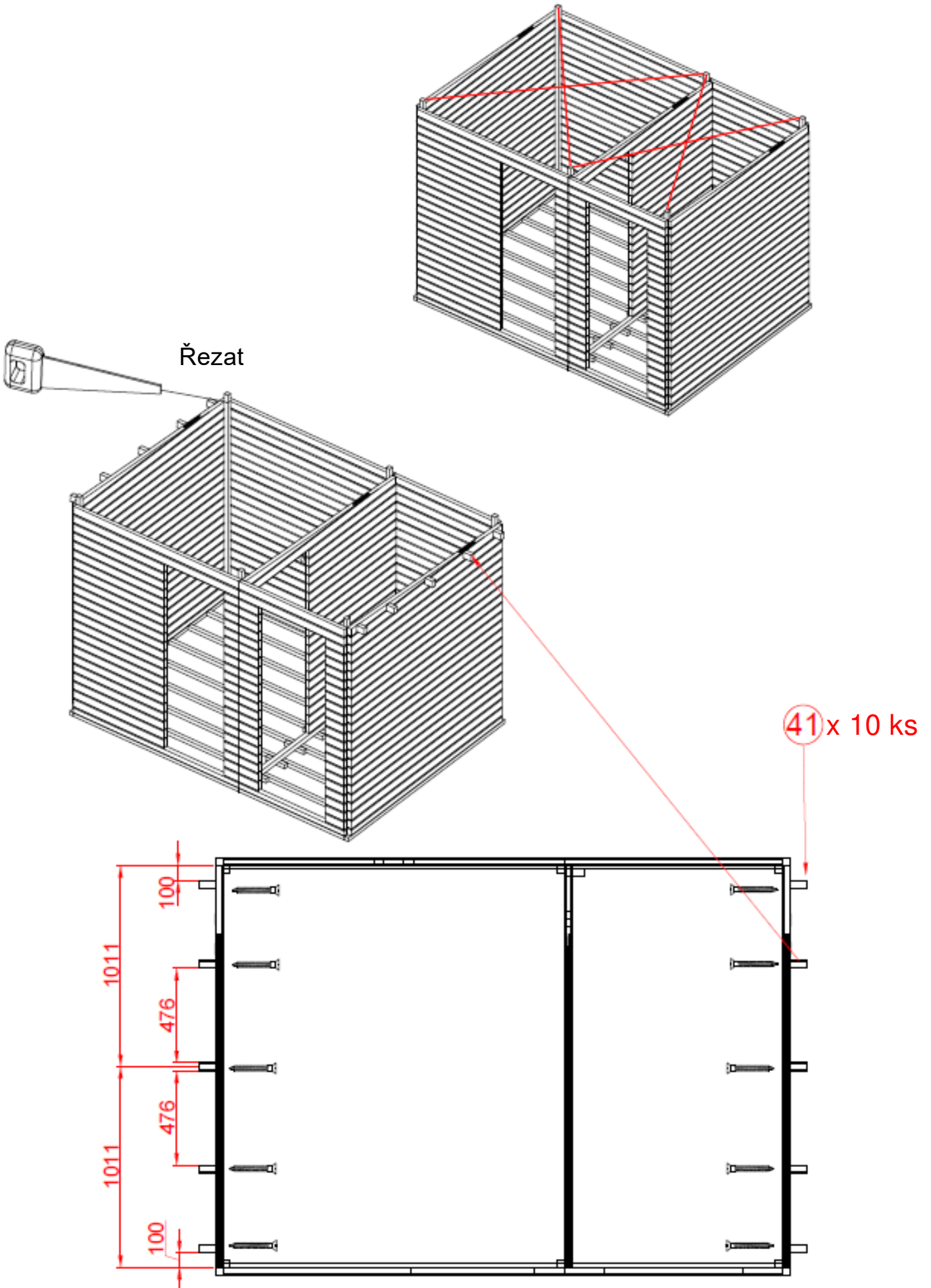

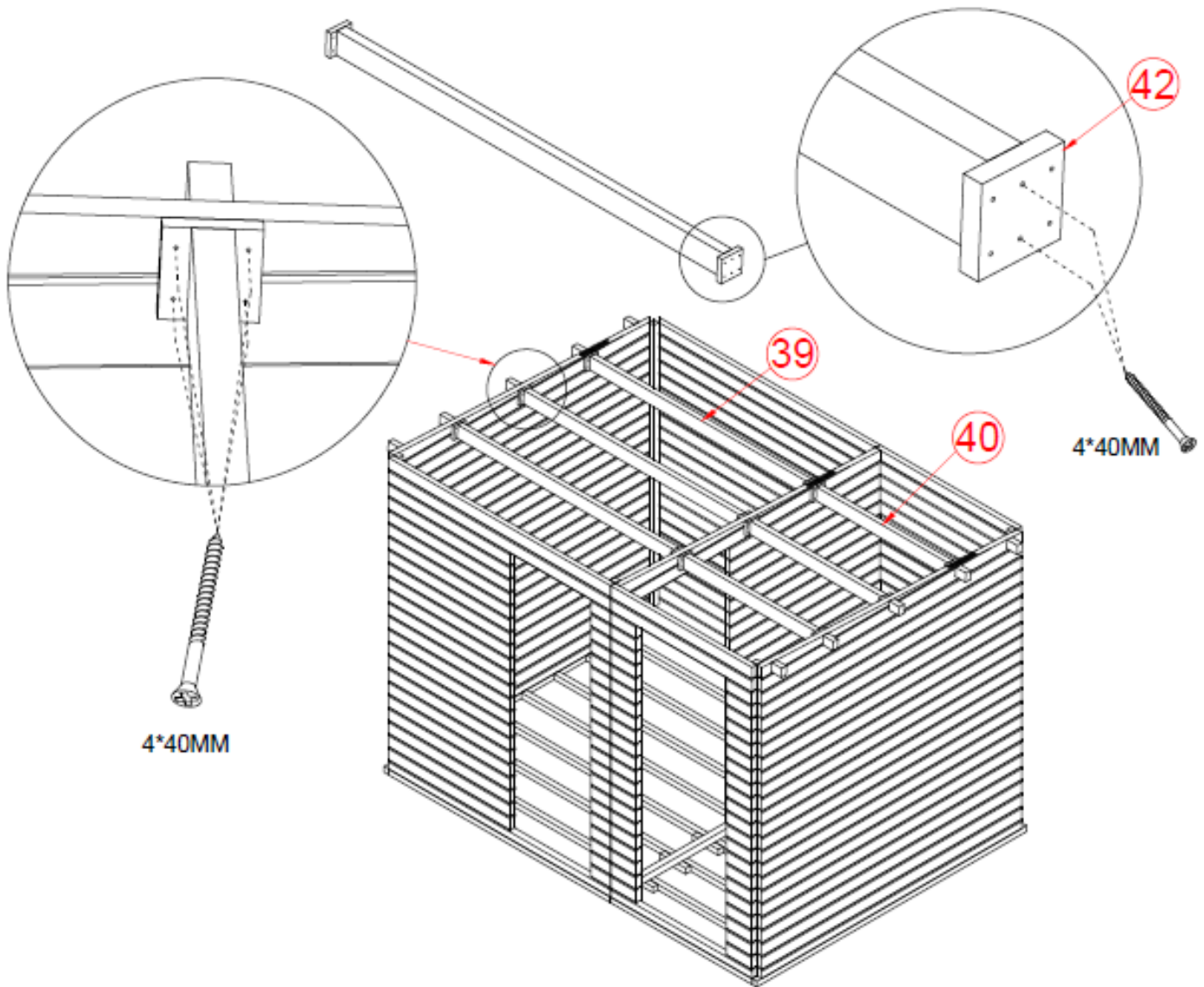

4*40MM

4*40MM

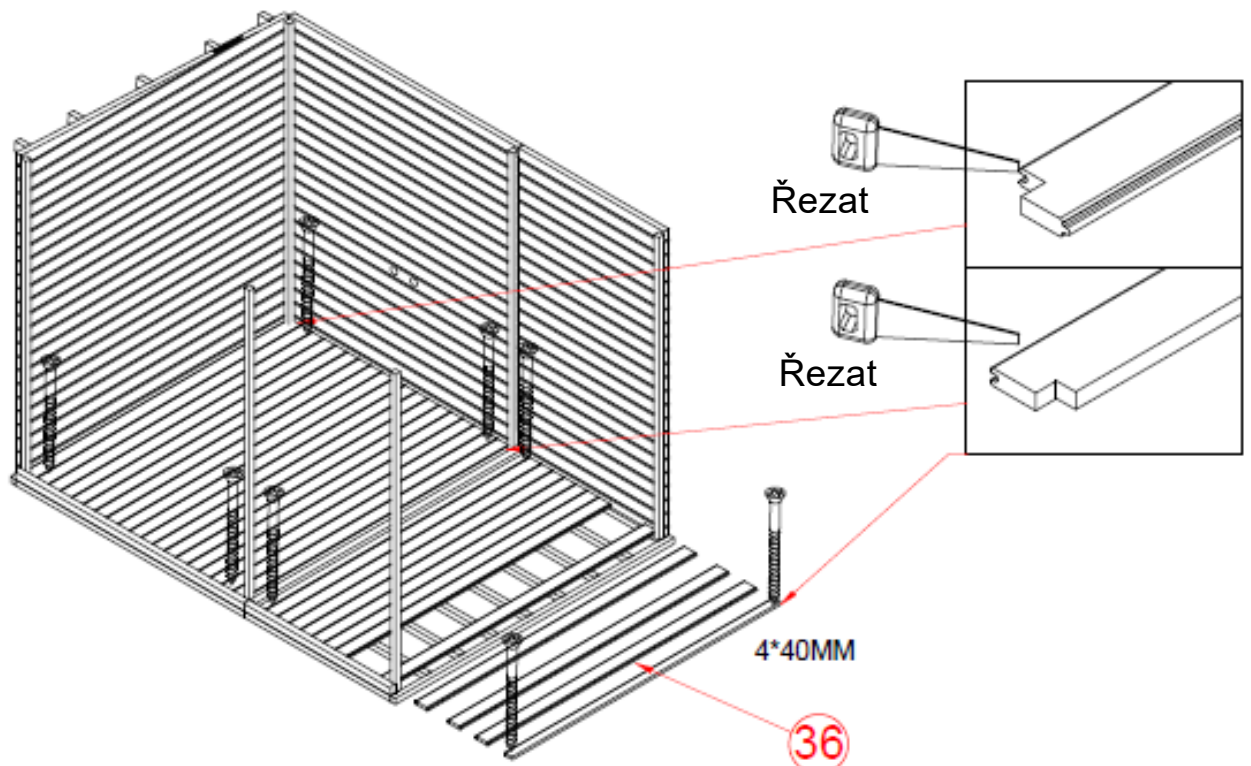

Řezat

Řezat

4*40MM

36

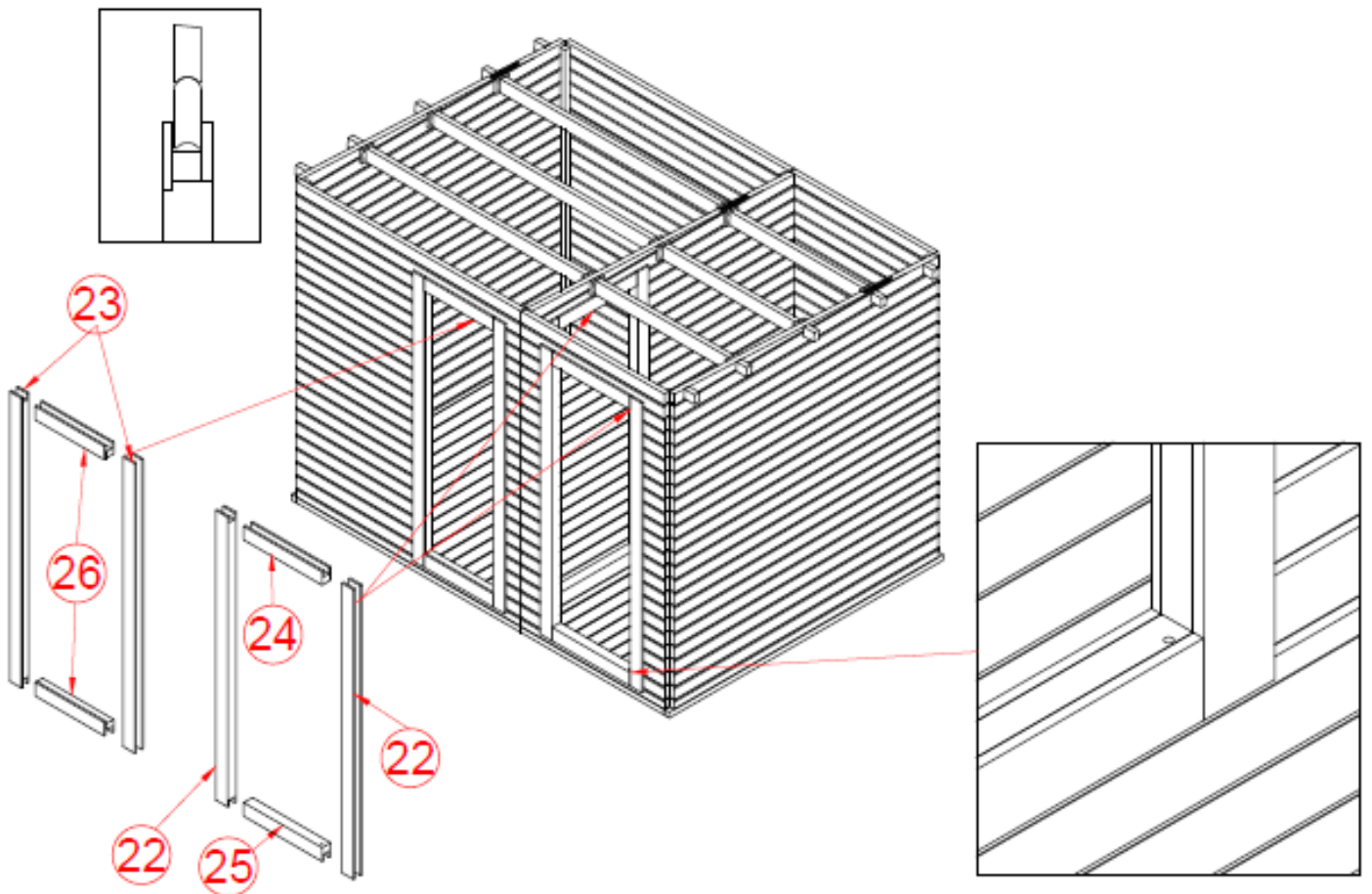
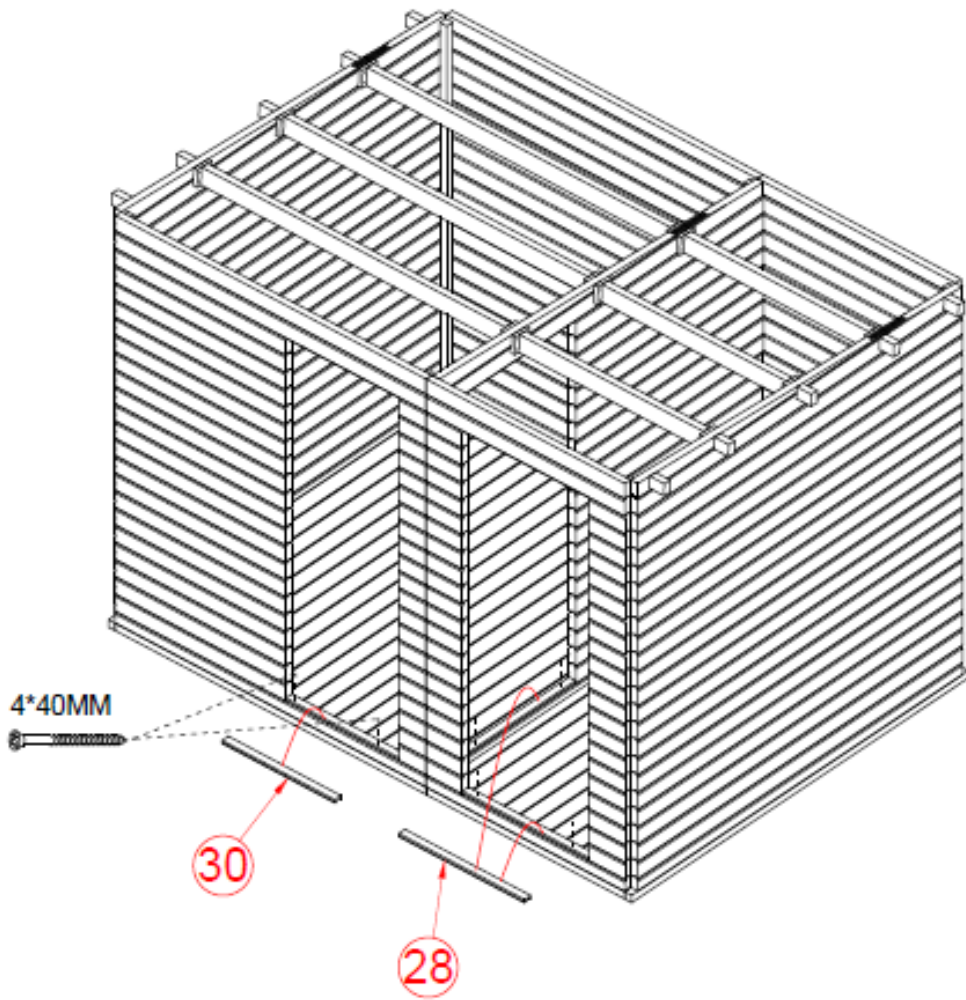

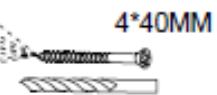
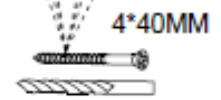
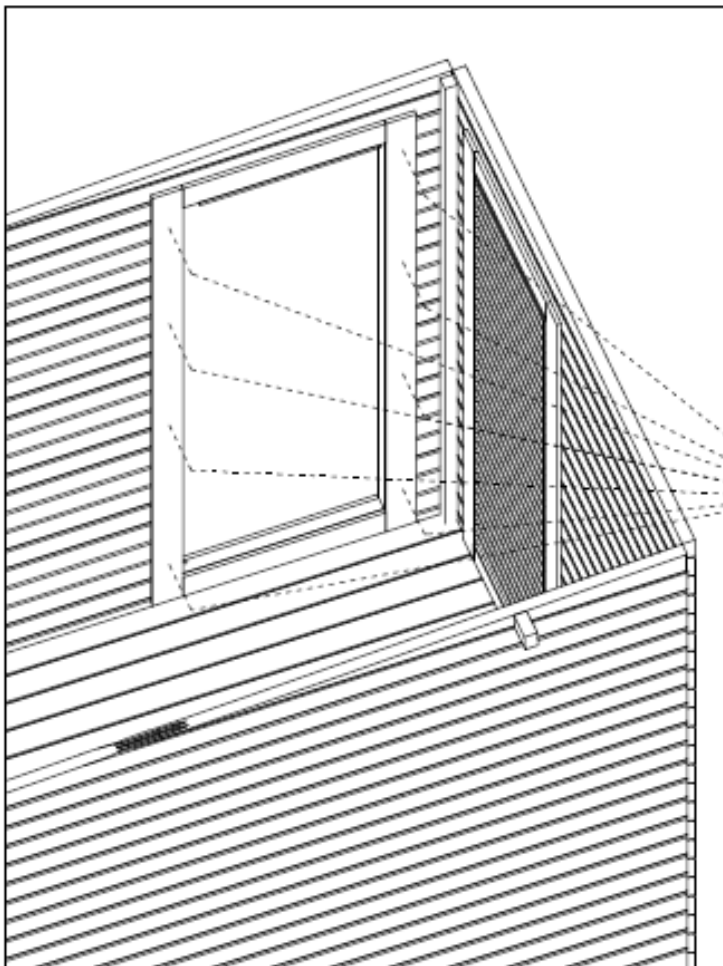
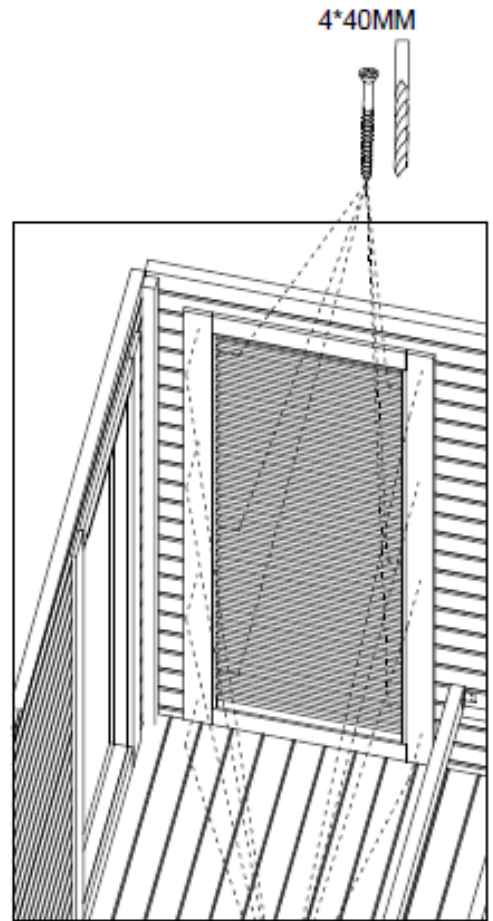
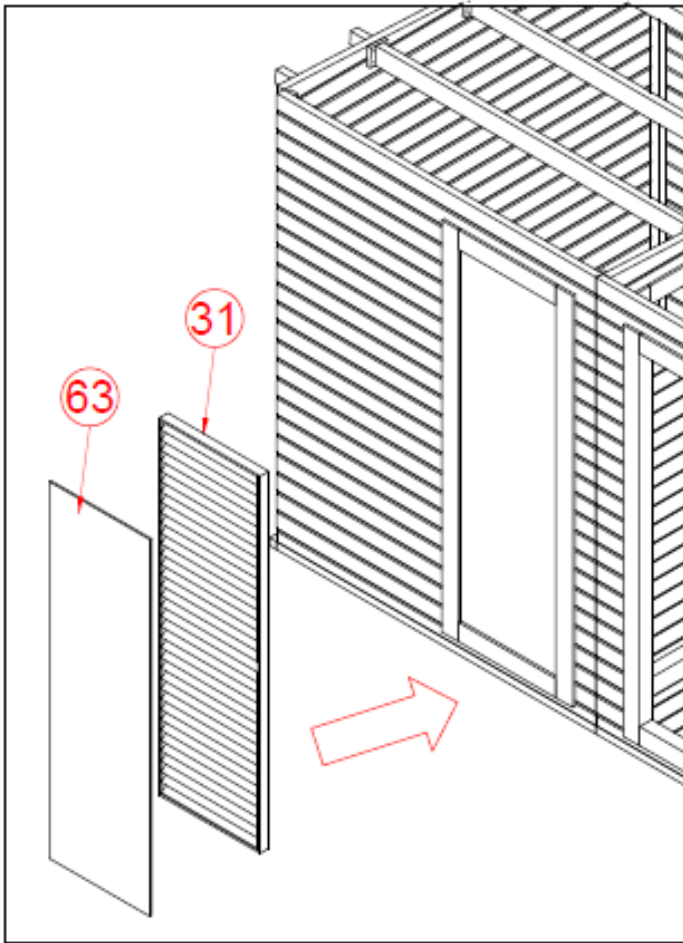

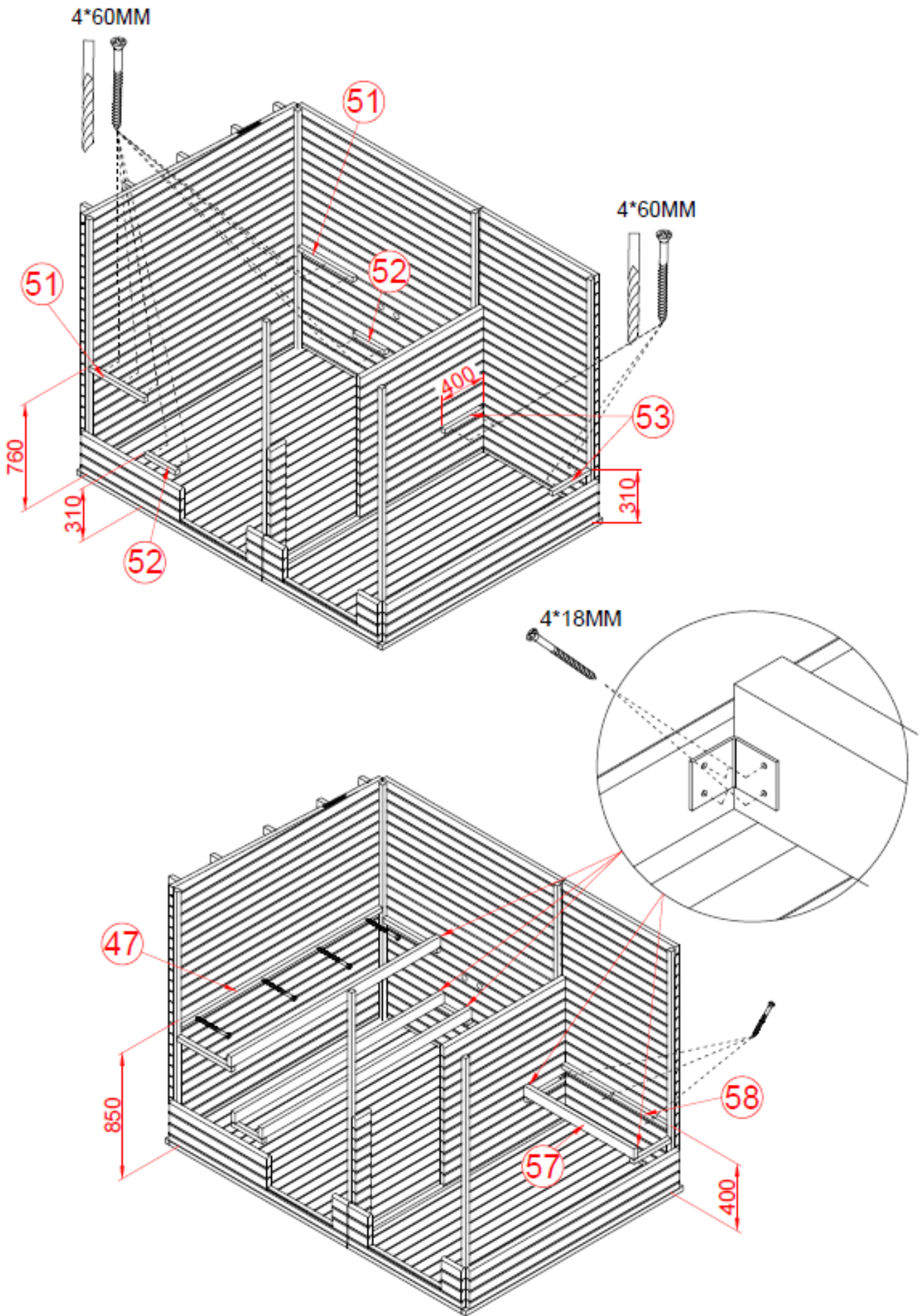

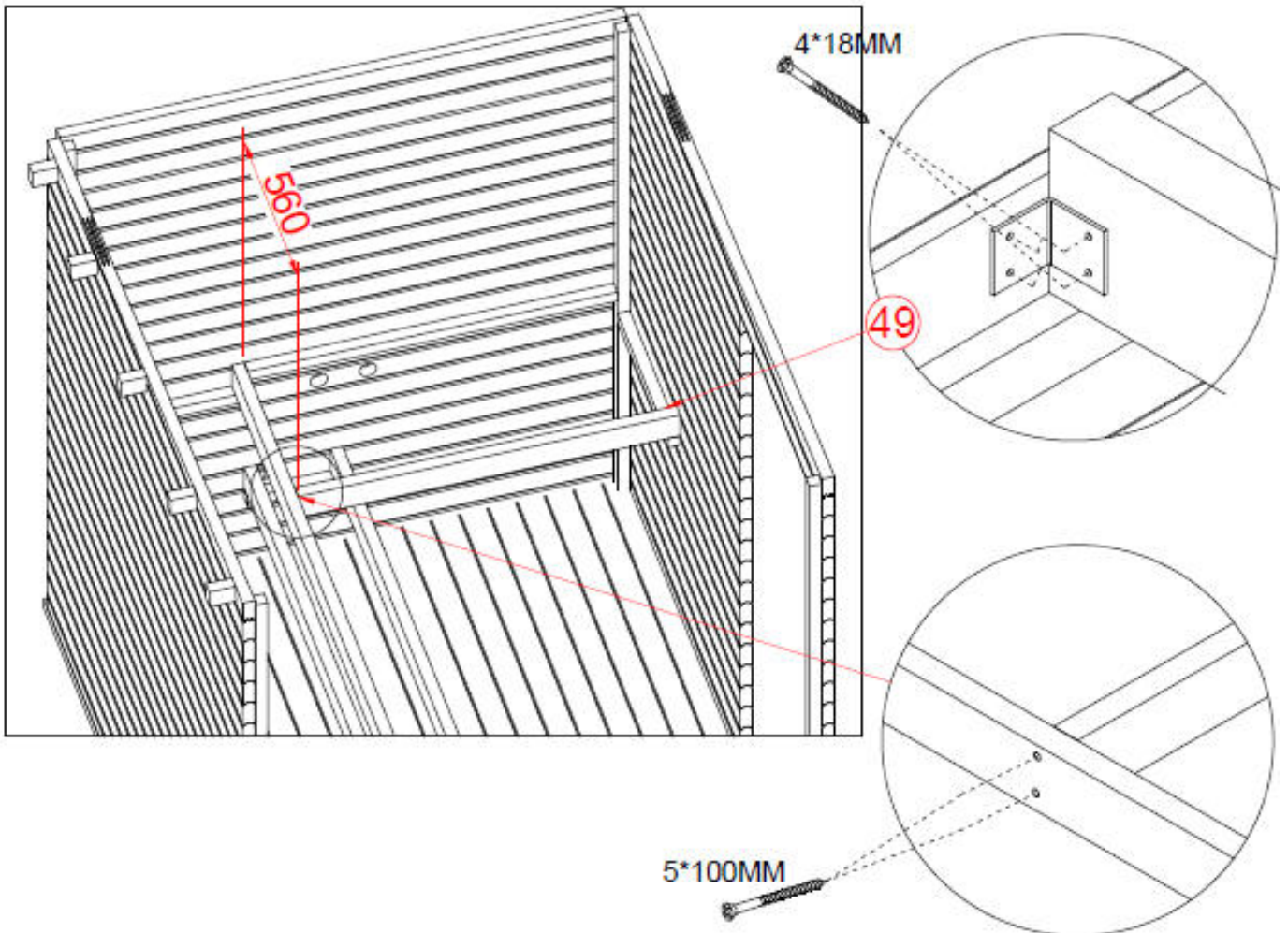
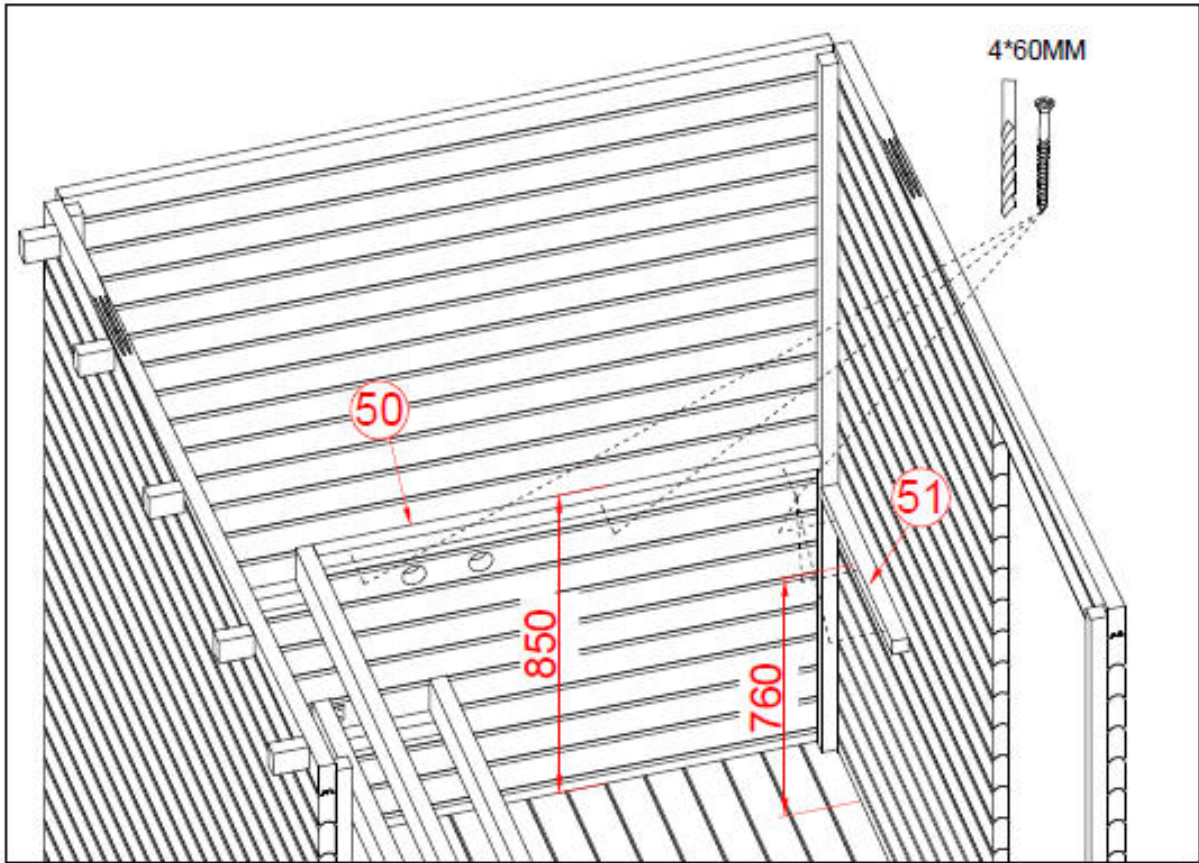

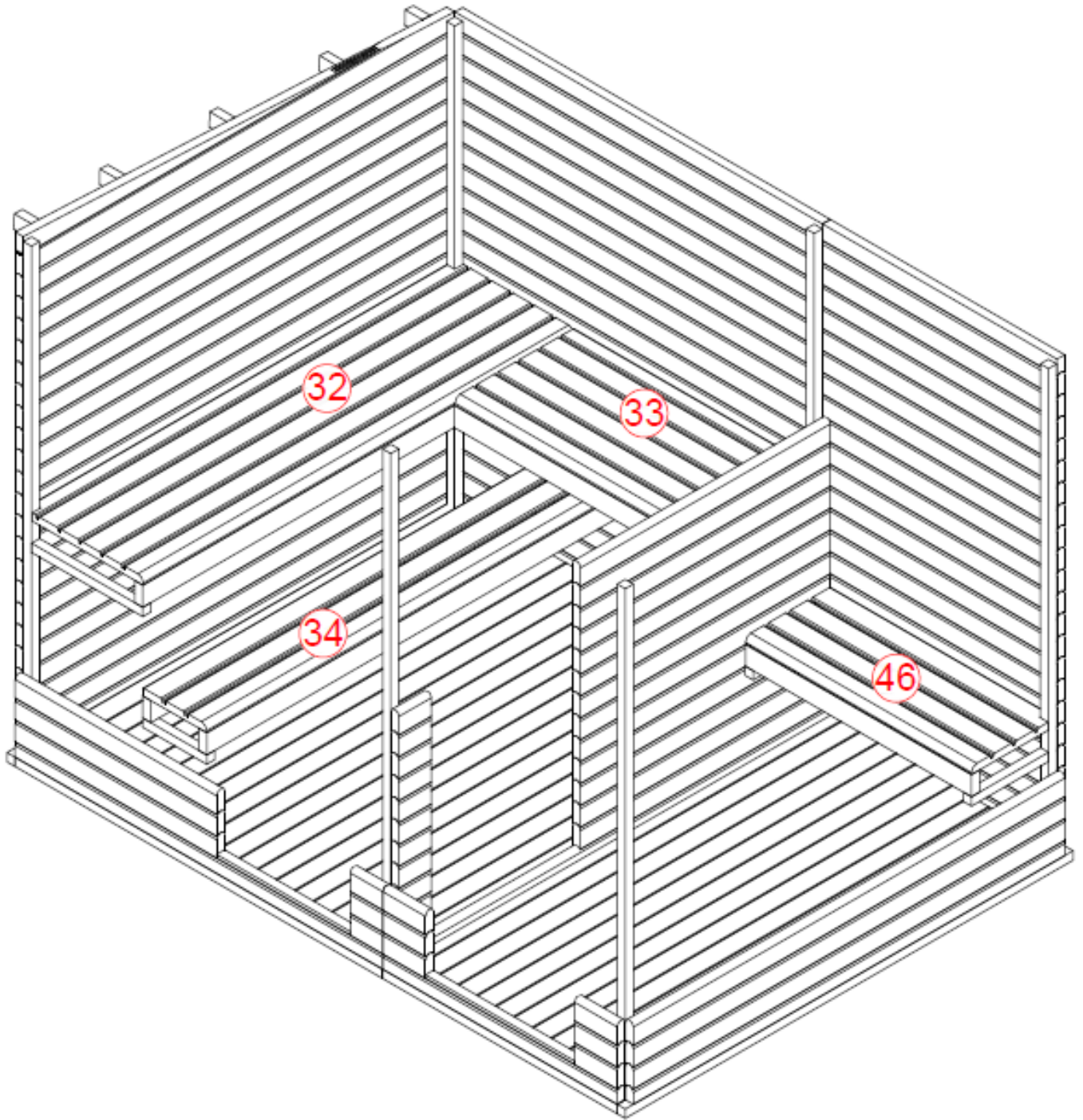

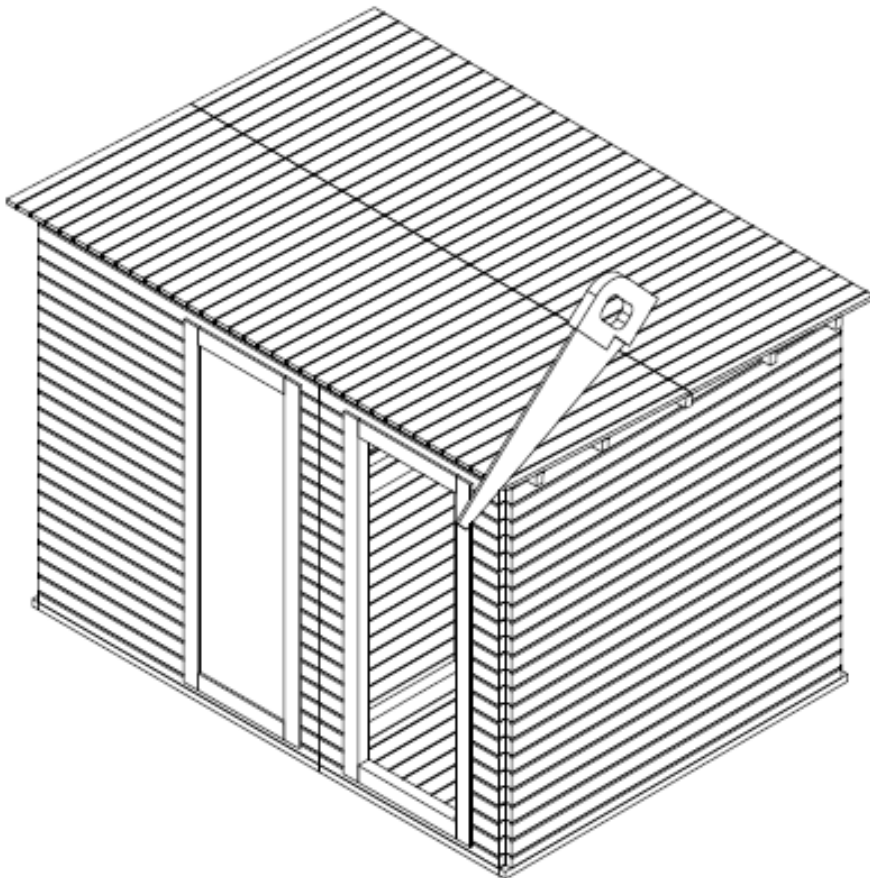
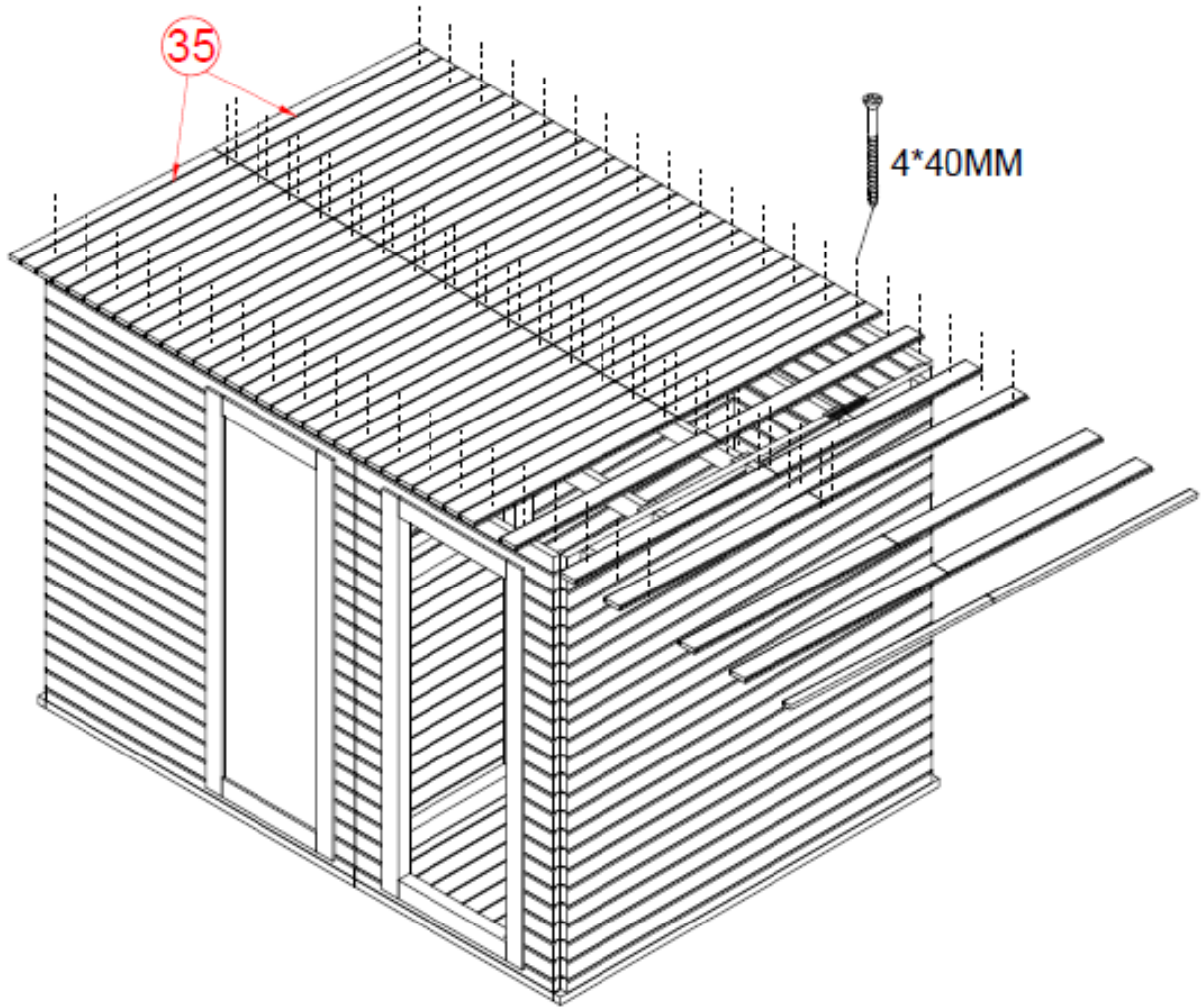

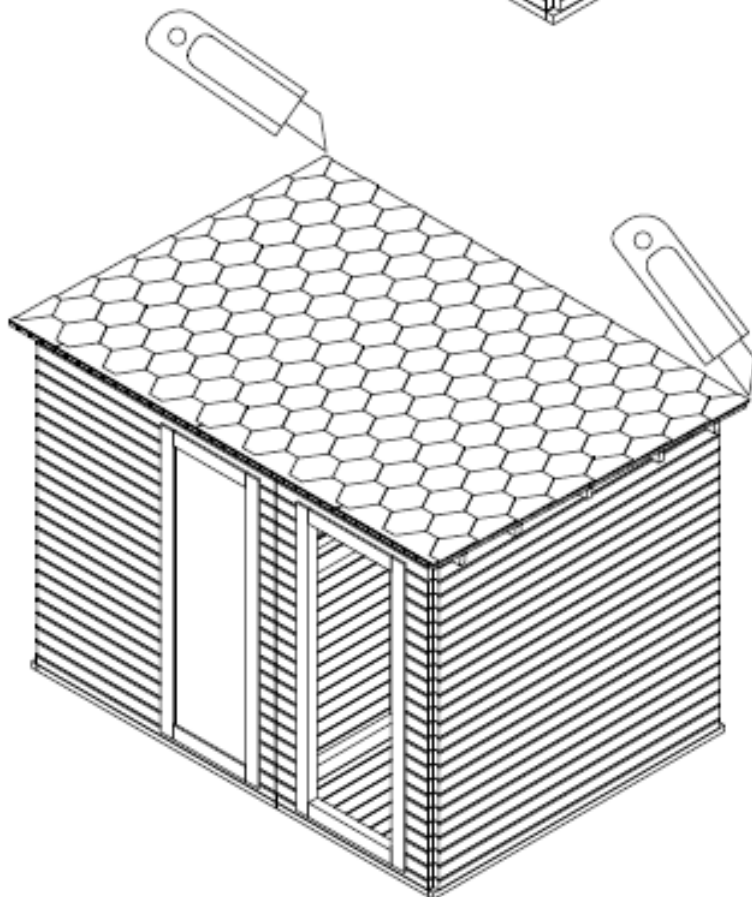
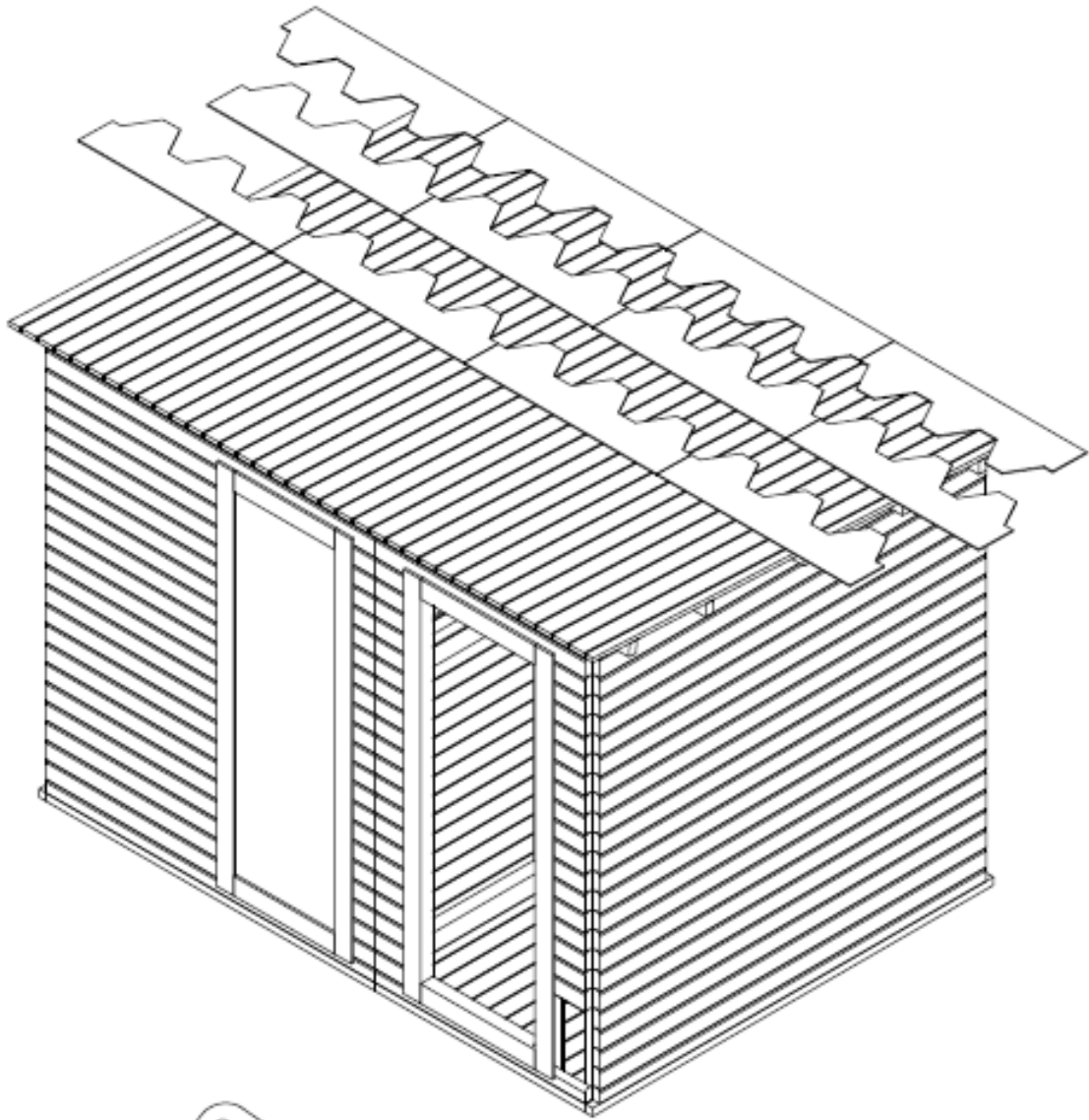

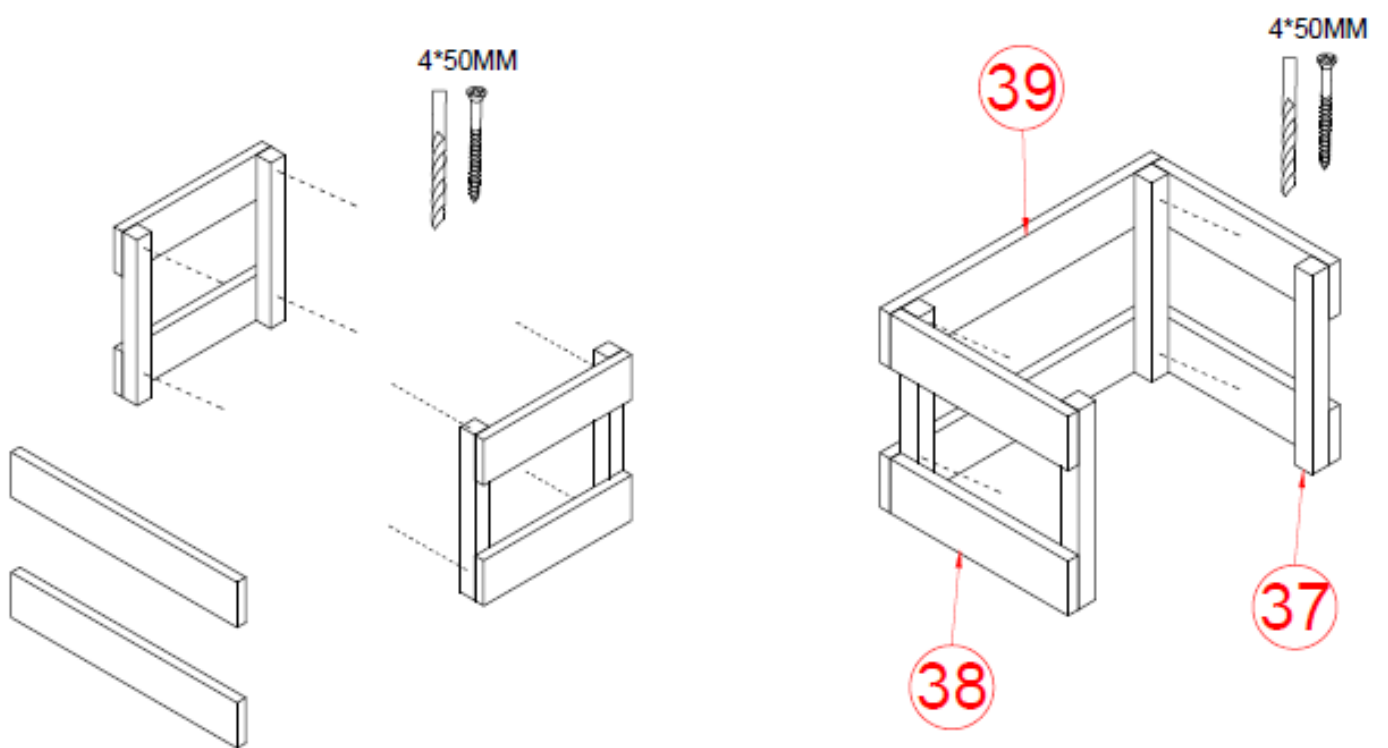
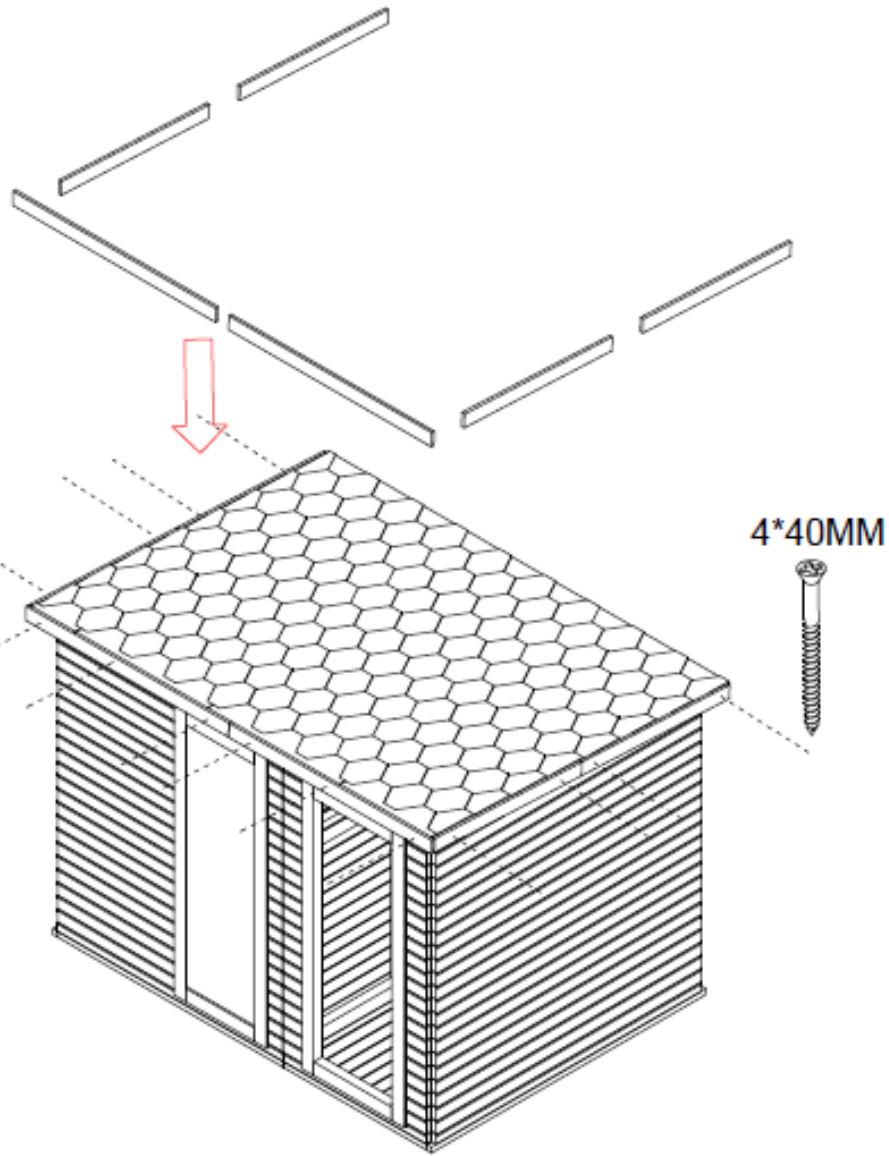

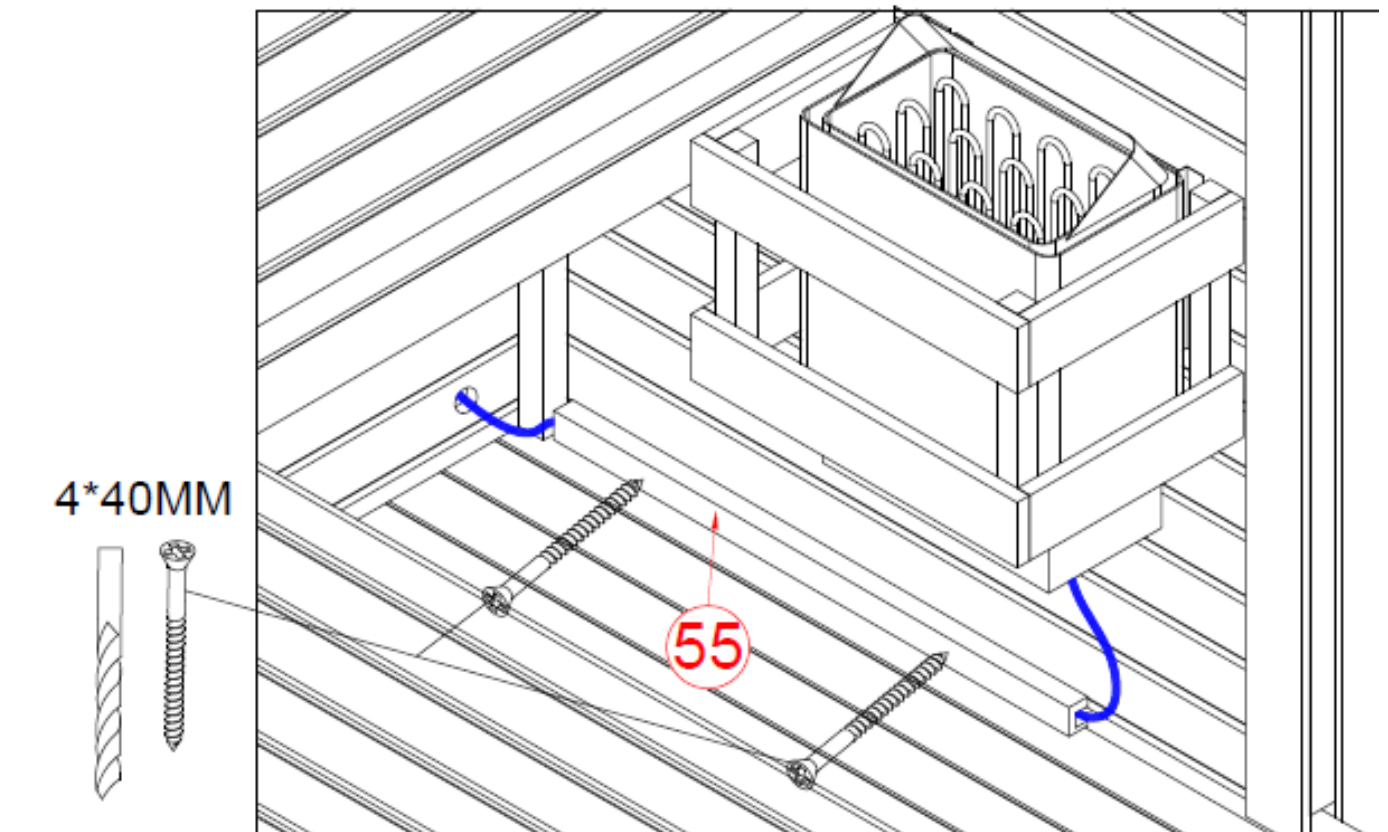
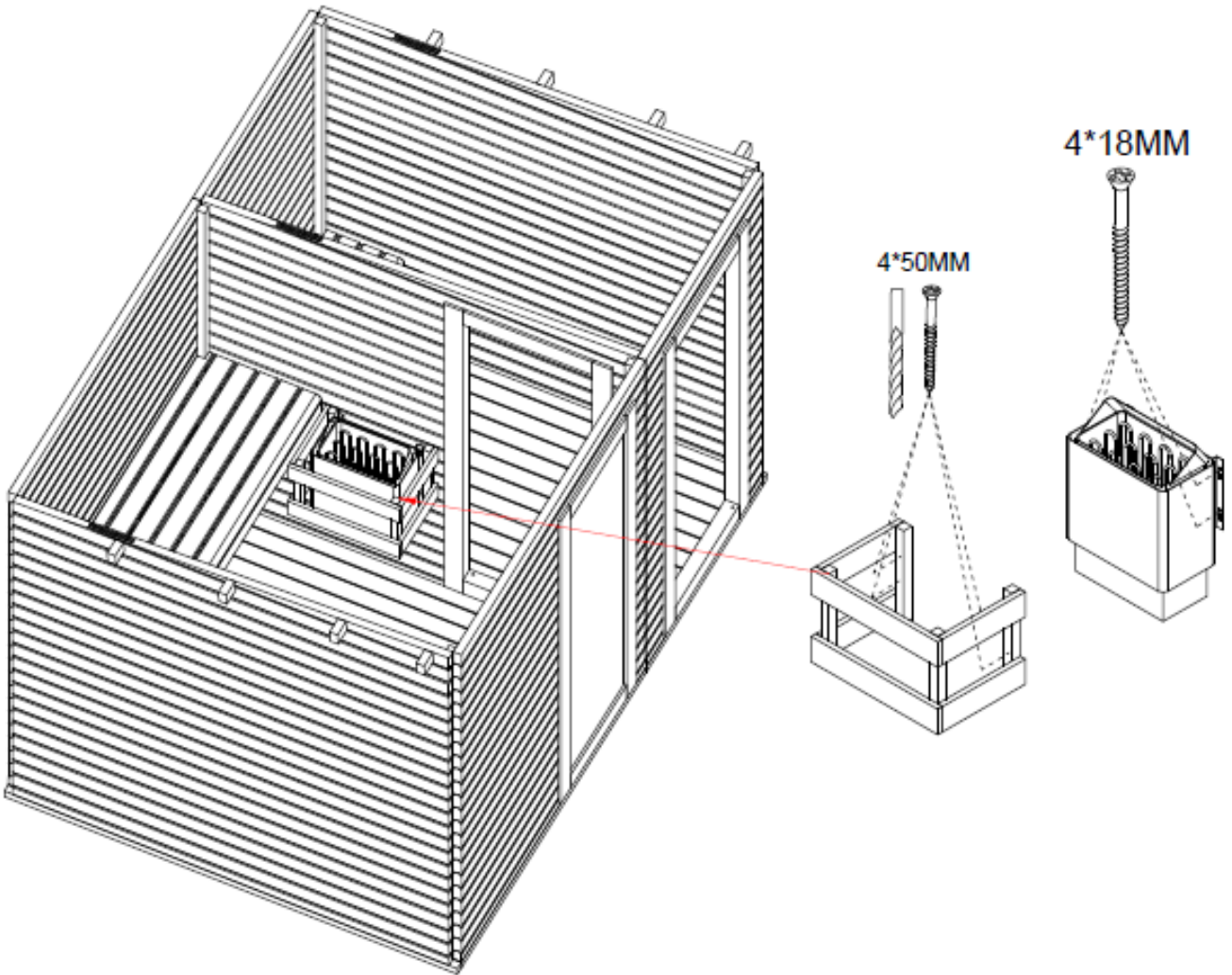

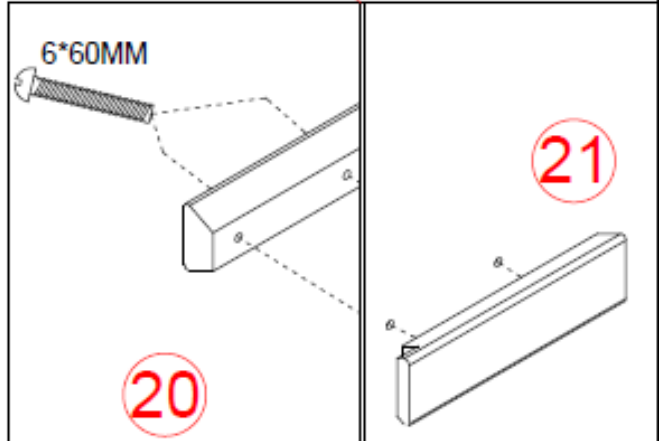
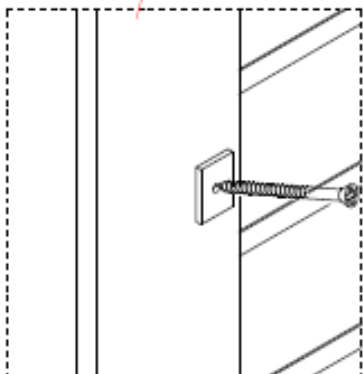
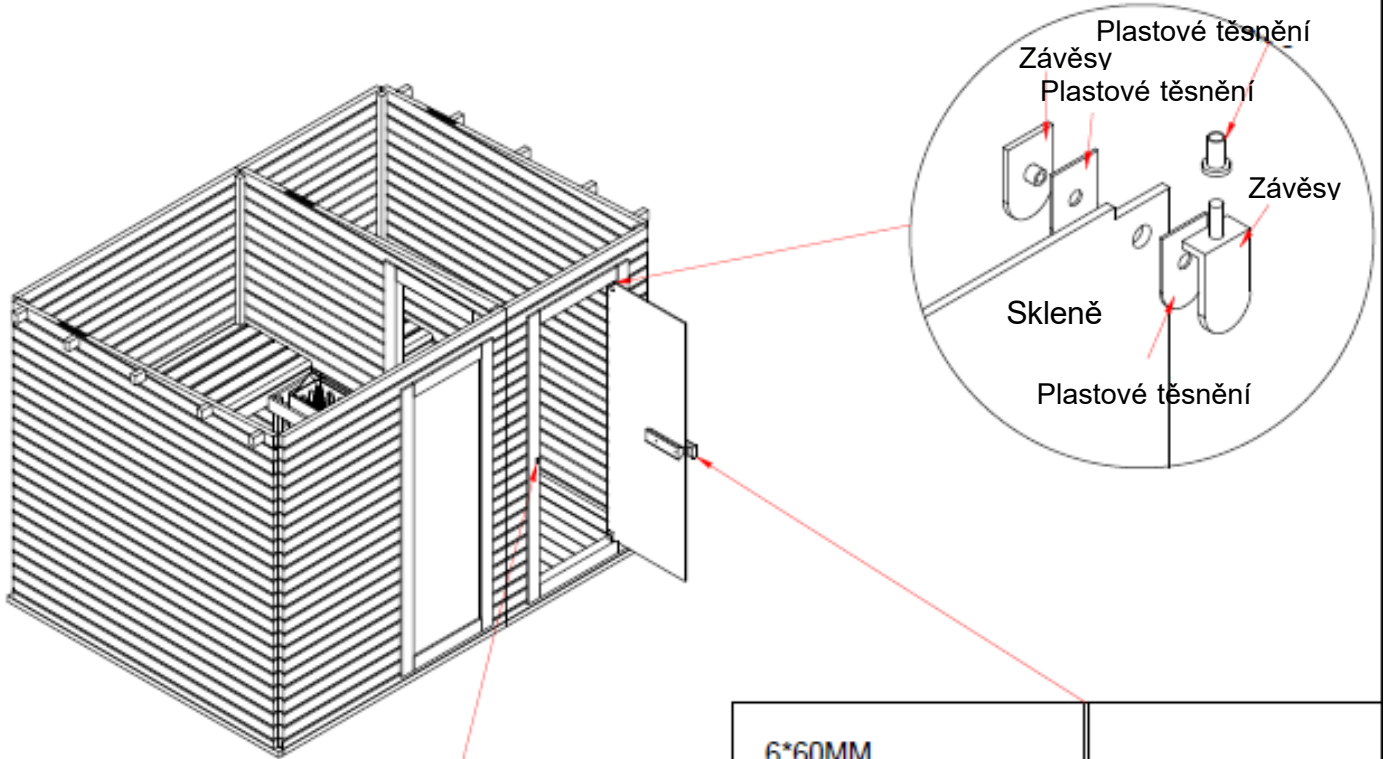
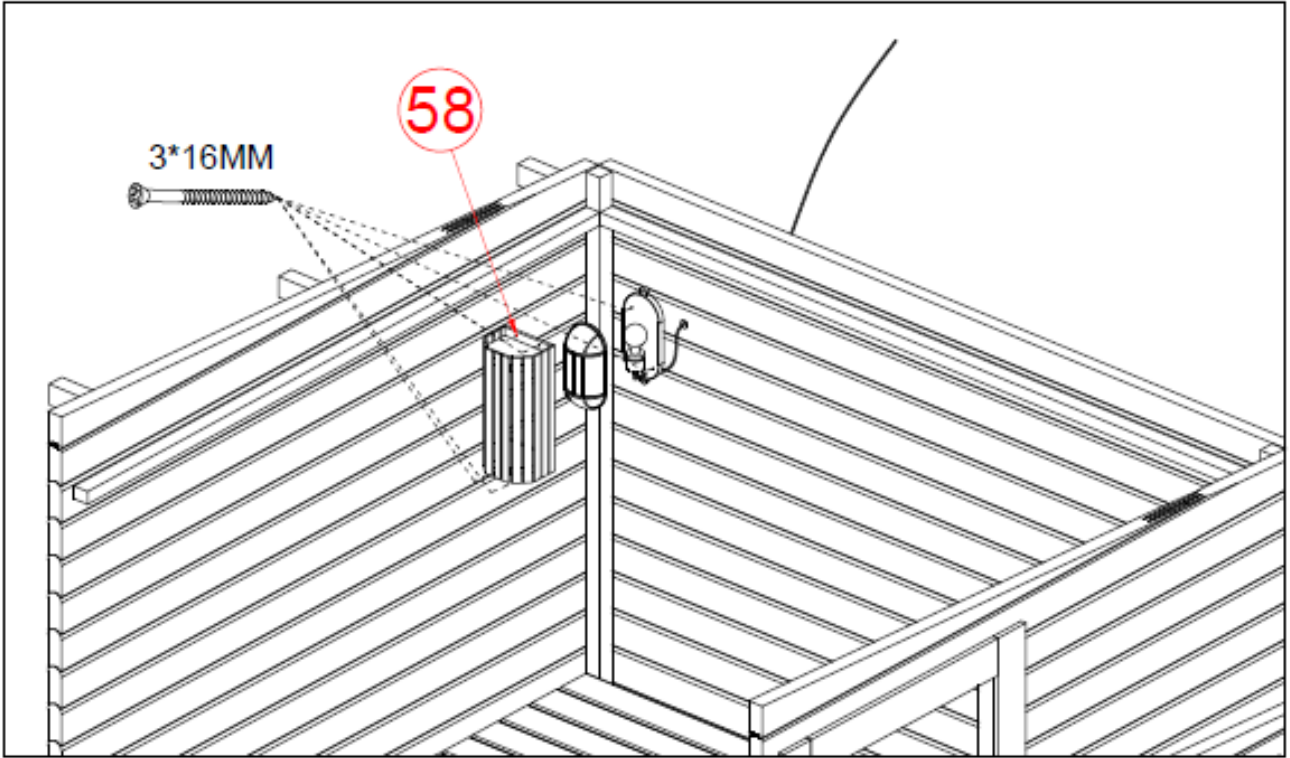

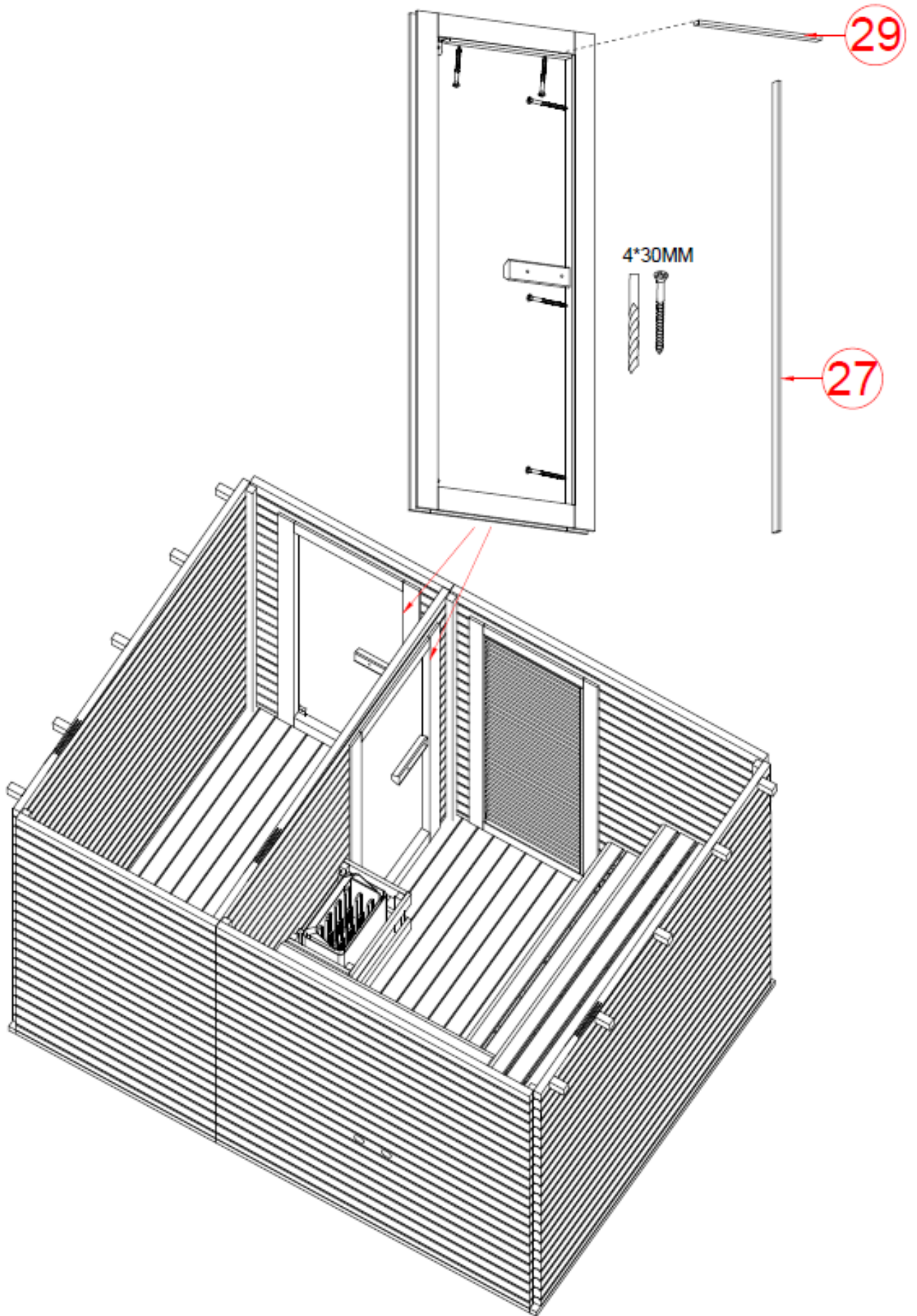

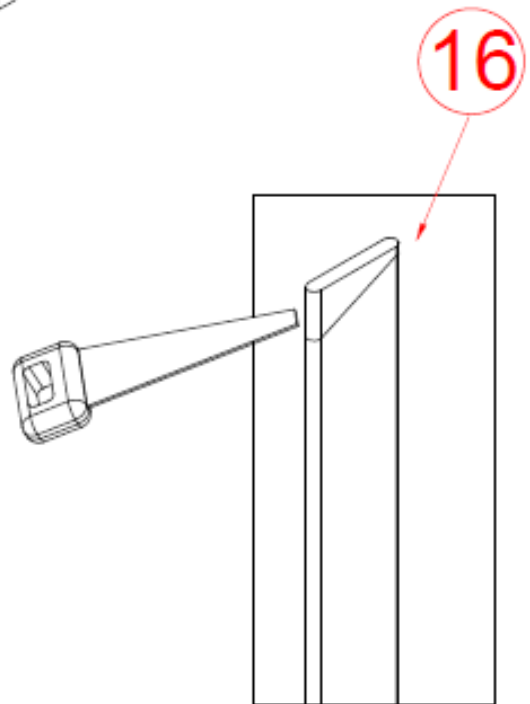
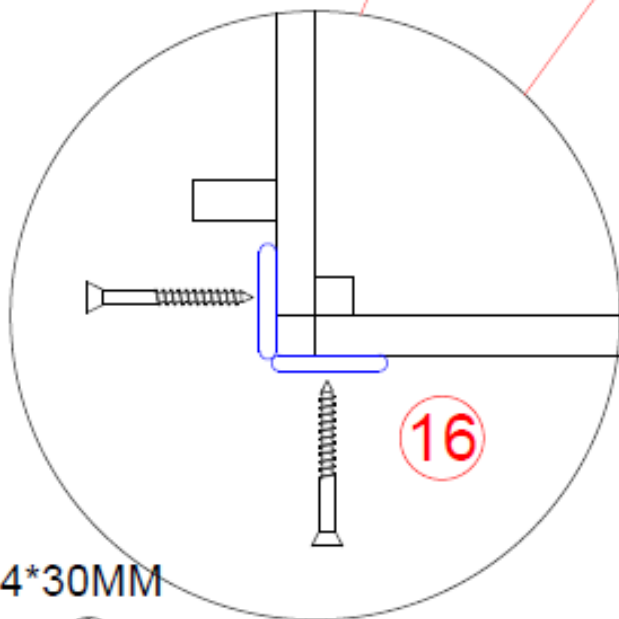
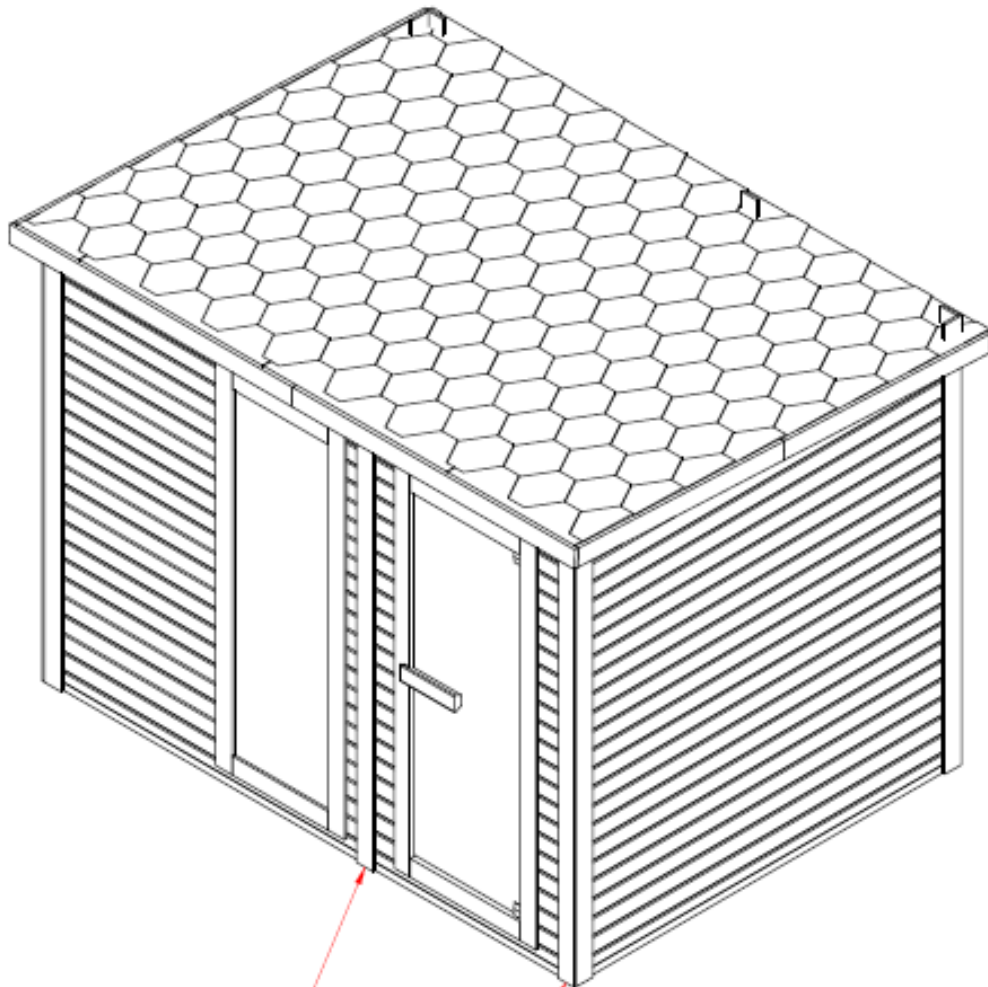

4*30MM

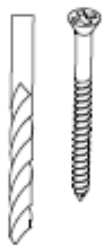

F30310

Navodila za uporabo

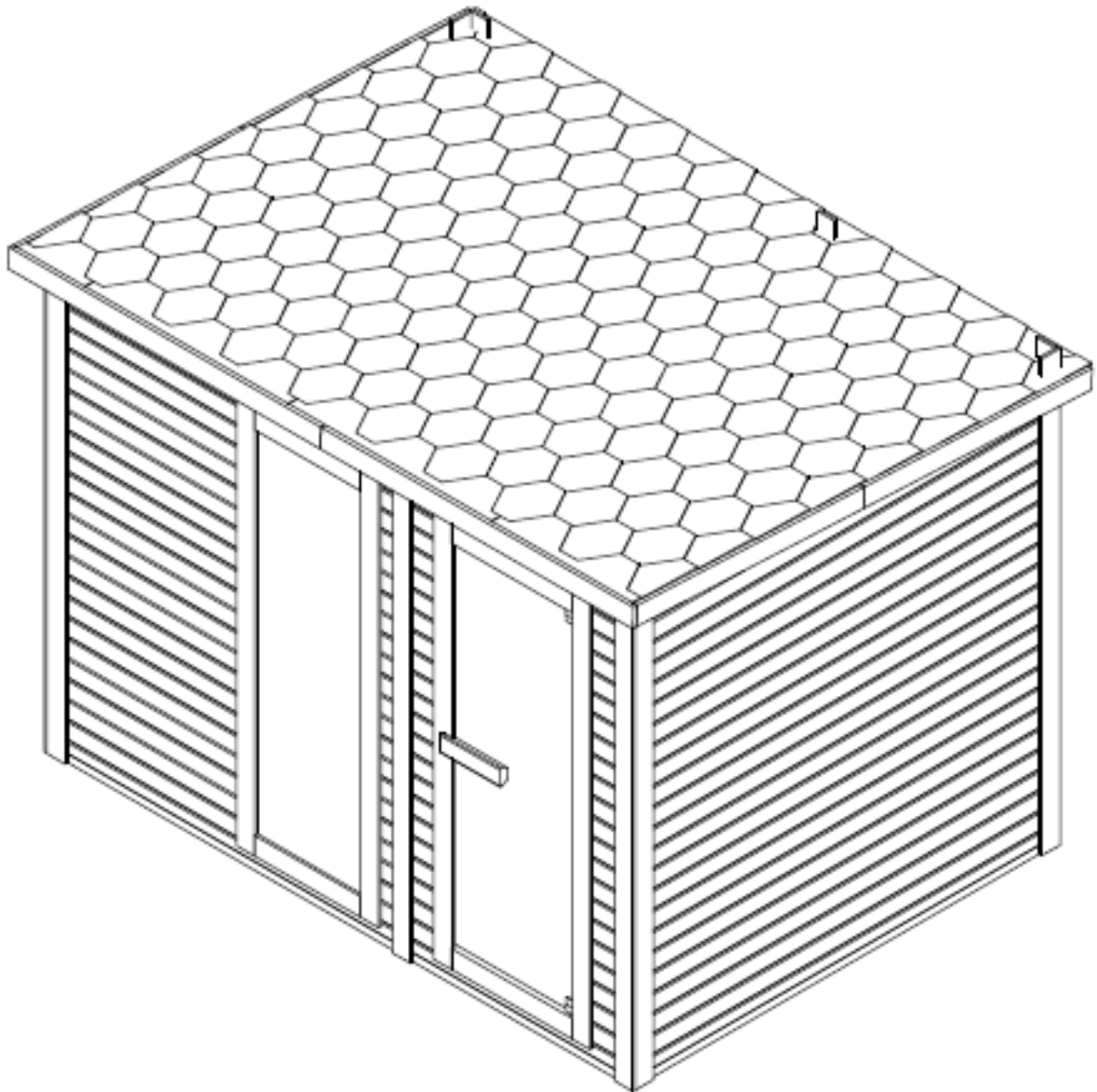

Priporočila

Pred prvo uporabo savne natančno preberite ta navodila.

Priporočamo, da jih hranite na varnem mestu, da vam bodo zmeraj dosegljiva. Zabeležite si serijsko številko kontrolne plošče, saj jo boste potrebovali v primeru popravila ali naročila rezervnih delov.

- Les je živ element. Da bi ohranili njegov prvotni videz, je treba les na zunanji strani zaščititi pred vlago.
- Postavite savno na popolnoma ravno in trdo površino.
- Ne uporabljajte tekočih čistilnih sredstev. Pred čiščenjem izklopite savno in uporabite le vlažno krpo.
- Zaščitite električni kabel savne, da se ne zmečka ali stisne.
- Pred zamenjavo določenih sestavnih delov se prepričajte, da jih je odobril proizvajalec ali da imajo enake lastnosti kot originalni deli. Nepravilna zamenjava lahko povzroči požar, kratek stik ali poškodbe savne. Priporočamo, da se posvetujete z usposobljenim tehnikom.
- Da bi se izognili nevarnosti opeklin ali električnega udara, ne uporabljajte kovinskih orodij.
- V savno ni dovoljeno prinašati živali.
- Savne ne puščajte vklopljene brez nadzora.
- Savne ne puščajte vklopljene več kot 1 uro naenkrat, da ne pride do prezgodnje poškodbe naprave. Po 1 uri neprekinjenega delovanja savno za vsaj 30 minut izklopite.
- Priporočljivo je, da na vrata savne ne namestite sistema za zaklepanje.
- Pred priključitvijo savne na električno omrežje preverite, ali vaša električna napeljava izpolnjuje zahteve.
- Namestitev in popravila sme izvajati samo usposobljen električar!
- Uporabljajte le originalne dele.
- Kadar savne ne uporabljate, jo izklopite.

NEVARNOST

- Pokrivanje peči povzroči nevarnost požara zaradi pregrevanja. Ne prekrivajte grelnih elementov!
- Vnetljive materiale in predmete (npr. brisače) vedno hranite stran od grelnih elementov.
- Med in kmalu po uporabi se ne dotikajte peči savne, ker obstaja nevarnost opeklin zaradi vročih delov.
- Žarnica se med delovanjem segreje. V primeru, da je žarnico potrebno zamenjati, savno izklopite in pustite, da se žarnica ohladi preden jo zamenjate.

Varnostne informacije

POMEMBNO!

Pred postavitvijo in uporabo kabine za savno natančno preberite varnostna navodila. So bistvenega pomena za vašo varnost, zato jih natančno upoštevajte.

Pazite na hipertermijo, toplotno kap ali vročinsko izčrpanost, ki jih lahko povzročite ali poslabšate, če ne upoštevate varnostnih navodil. Simptomi so vročina, hiter utrip, omotica, omedlevica, letargija in odrevenelost. Posledice so zmanjšano zaznavanje toplote, ne zavedanje grozeče nevarnosti in nezavest.

Savne ne smejo uporabljati:

- otroci mlajši od 6 let.
- ljudje s hudimi reakcijami na sončno svetlobo.
- starejše osebe ali invalidi.
- ljudje z že obstoječimi boleznimi, kot so bolezni srca, visok ali nizek krvni tlak, težave s krvnim obtokom ali sladkorna bolezen, brez predhodnega zdravniškega nasveta.
- nosečnice. Previsoka temperatura lahko ogrozi plod.
- osebe z dehidracijo, odprtimi ranami, očesnimi boleznimi, opeklinami ali sončarico.

Otroci, stari od 6 do 16 let, lahko uporabljajo savno, če so ves čas pod nadzorom odgovorne odrasle osebe in če temperatura v savni ne presega 60 °C.

Če imate zdravstvene težave, jemljete zdravila ali imate poškodovane mišice ali vezi, lahko savno uporabljate le po predhodnem posvetu in odobritvi zdravnika.

Če nosite kirurške vsadke, ne uporabljajte savne, ne da bi se prej posvetovali z zdravnikom in pridobili njegovo soglasje. Savne ne uporabljajte po naporni dejavnosti.

Počakajte 30 minut, da se vaše telo ohladi.

V savni ne preživite več kot 40 minut naenkrat.

Pred ali med savnanjem ne uživajte alkohola ali drog.

V delujoči savni ne spite.

Da bi se izognili nevarnosti pregrevanja, savno priključite v dovolj močno vtičnico in v isto vtičnico ne priključite drugih električnih naprav.

Da bi se izognili nevarnosti električnega udara ali poškodbam savne, je ne smete uporabljati:

- med nevihto.
- če je električni kabel poškodovan, ga mora zamenjati usposobljena oseba.
- če se električni kabel pregreje, ga mora preveriti usposobljena oseba.
- če morate zamenjati žarnico, počakajte, da je savna izklopljena in se ohladi.
- Preden priključite ali izključite napajanje, si osušite roke.

Nikoli ne delajte z mokrimi rokami ali nogami.

Ne vklaplajte ali izklaplajte napajanja ali ogrevalnega sistema na hitro, saj lahko to povzroči poškodbe električnega sistema.

Savne ne poskušajte popravljati sami, ne da bi za to pridobili soglasje prodajalca ali proizvajalca.

Nepooblaščen poskusi popravila bodo povzročili izgubo proizvajalčeve garancije.

V savni ne uporabljajte nobenih čistilnih sredstev.

V savno ali na njo ne zlagajte ali shranjujte nobenih predmetov.

V bližini savne ne postavljajte vnetljivih materialov ali kemičnih snovi.

Ne pokrivajte grelnih elementov!





Ne dotikajte se grelcev med ali takoj po uporabi, ker obstaja nevarnost opeklin.



Kadar kabine ne uporabljate, jo izklopite.

Tehnični podatki:

model	F30310
material kabine	smrekov les
globina	2300mm
širina	3100mm
višina	2200mm
napetost	AC380V
peč za savno	8KW

Montažni material (možna odstopanja)

											
Ø3x16	Ø4x70	Ø4x60	Ø4x50	Ø4*40	Ø4*30	Ø4*18	Ø5*100	Ø6x60	Wood pad		
6x	103x	300x	76x	240x	62x	40x	2x	4x	2x	2x	4x

		
2x	10x	2x

Preden začnete z montažo, odstranite transportno embalažo in preverite, ali je bila vaša infrardeča kabina dostavljena popolna in nepoškodovana.

Podrobno preberite navodila za montažo preden izberete primerno mesto za savno. Savna je zasnovana samo za zunanjo postavitev.

Izberite mesto:

- Na suhem mestu na ravni, stabilni površini, ki lahko prenese težo vaše savne.
- Višina mora biti zadostna, da lahko dosežete strop in opravite električne povezave in vzdrževalna dela.
- Postavite ločeno od virov vode, ognja ali vnetljivih materialov.

Praktični nasveti

- upoštevajte, da sta za postavitev savne potrebni vsaj 2 odrasli osebi.
- preden začnete, jasno identificirajte vsako ploščo
- pri namestitvi napajalni kabel vaše savne postavite tako, da je lahko dostopen.
- upoštevajte, da obstajajo razlike med modeli.

POMEMBNO :





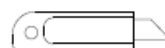
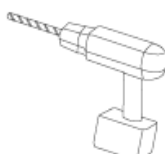
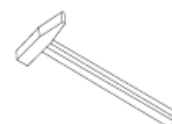
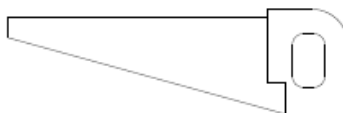
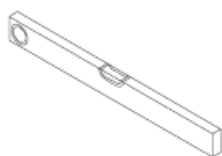



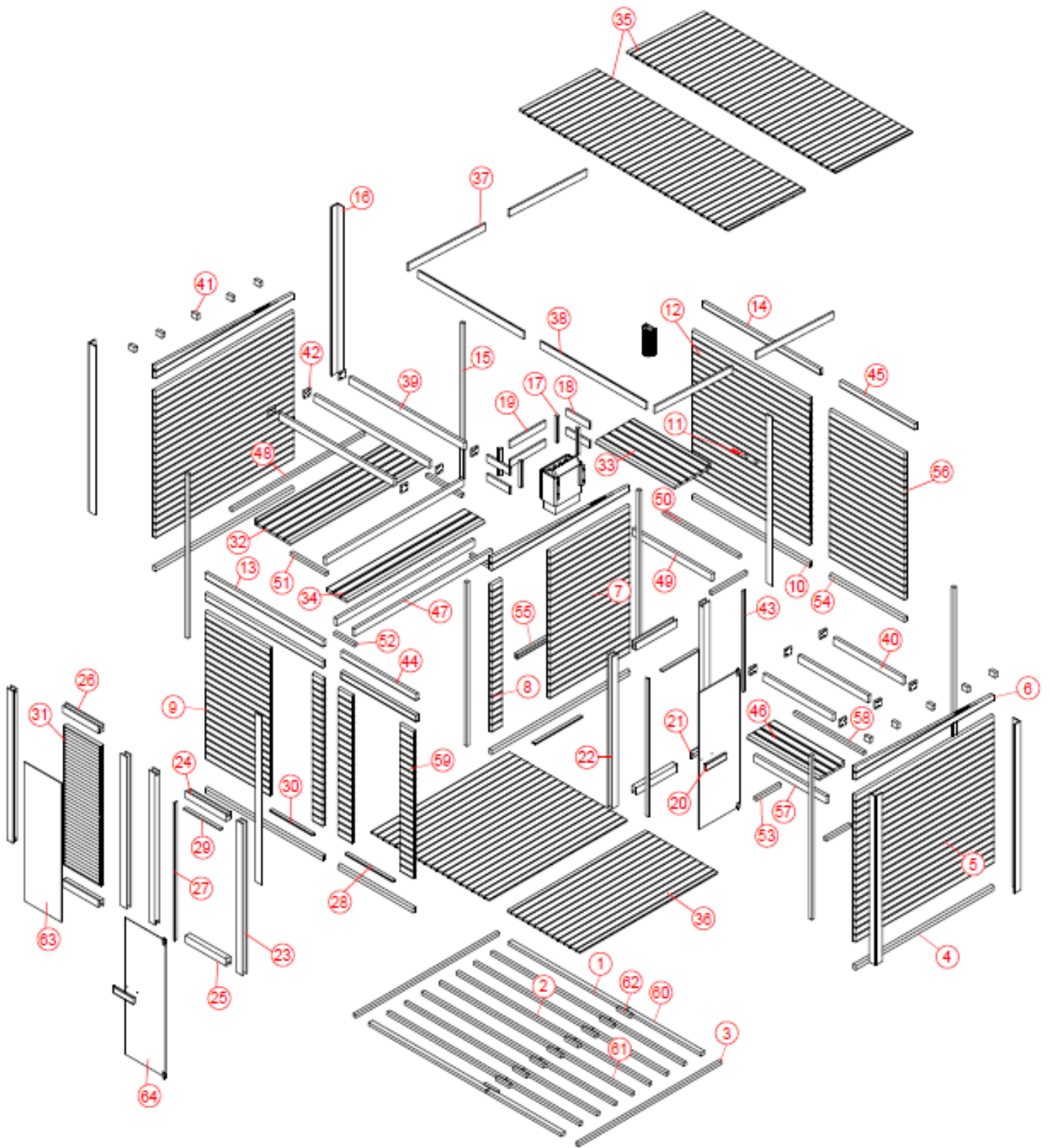

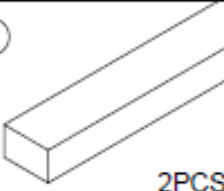
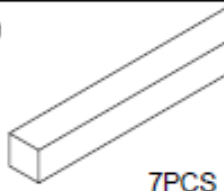
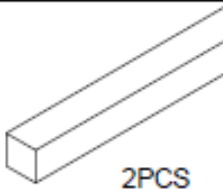
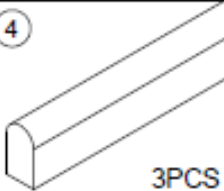
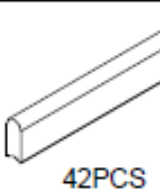

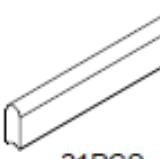

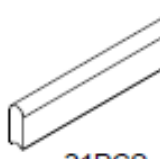
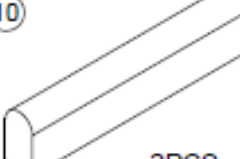
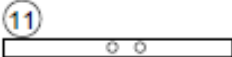
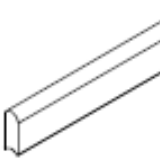



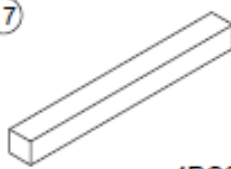

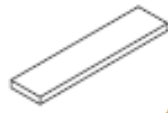
Preverite grezilo in premer izvrtin, da ne poškodujete lesa

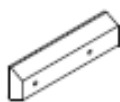
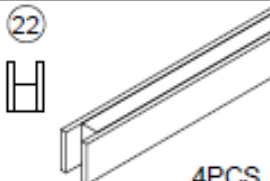
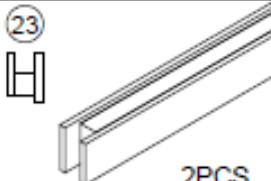
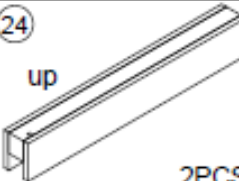
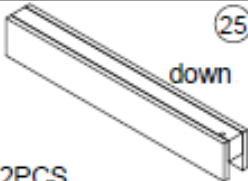
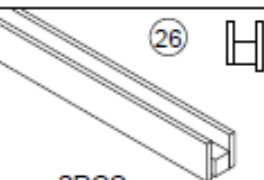
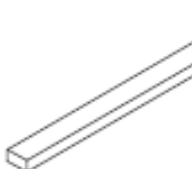
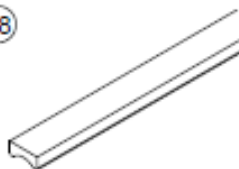

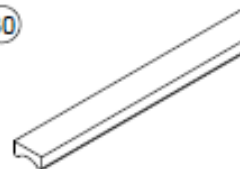

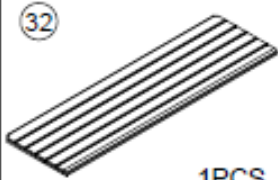
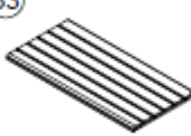

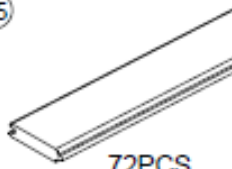
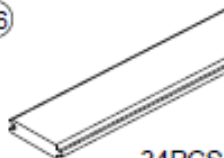

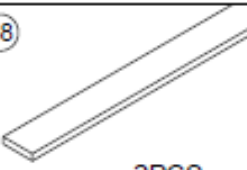
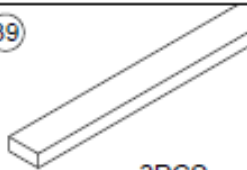
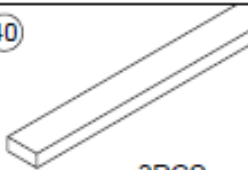



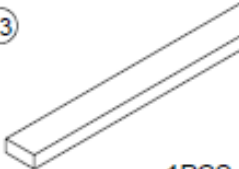

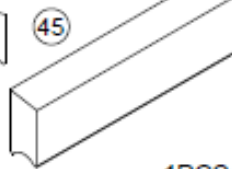
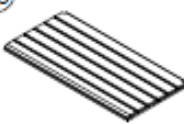
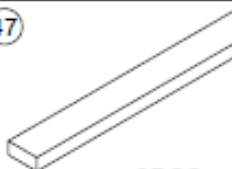

Orodja:

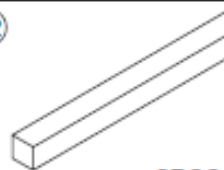
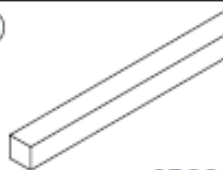

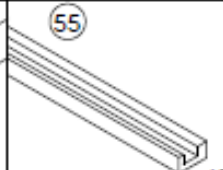
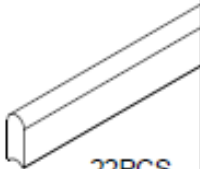
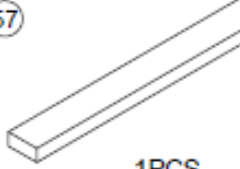
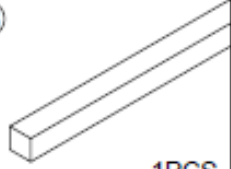
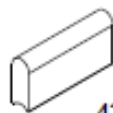
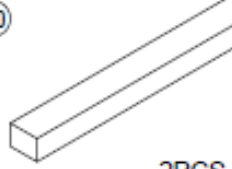
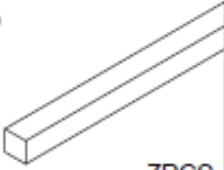
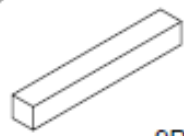
Seznam delov:



①  2PCS 1724*55*38mm	②  7PCS 1724*38*38mm	③  2PCS 2100*38*38mm	④  3PCS 2024*67*38mm	⑤  42PCS 2024*97*38mm
⑥  3PCS 2024*168*38mm	⑦  21PCS 1172*97*38mm	⑧  42PCS 150*97*38mm	⑨  21PCS 945*97*38mm	⑩  2PCS 1724*67*38mm
⑪  1PCS 1724*97*38mm	⑫  21PCS 1724*97*38mm	⑬  1PCS 1724*81*38mm	⑭  1PCS 1724*70*38mm	⑮  6PCS 2188*38*38mm
⑯  10PCS 2140*90*13mm	⑰  4PCS 330*33*33mm	⑱  2PCS 520*90*20mm	⑲  4PCS 340*90*20mm	⑳  1PCS 300*90*40mm
㉑  1PCS 252*90*40mm	㉒  4PCS 1927*90*66mm	㉓  2PCS 1927*90*66mm	㉔  2PCS 600*90*66mm	㉕  2PCS 600*90*66mm
㉖  2PCS 547*90*66mm	㉗  2PCS 1747*40*13mm	㉘  2PCS 700*38*17mm	㉙  2PCS 537*40*13mm	㉚  1PCS 627*38*17mm
㉛  1PCS 1765*545*47mm	㉜  1PCS 2022*560*33mm	㉝  1PCS 1162*560*33mm	㉞  1PCS 2022*300*33mm	㉟  72PCS 1130*97*18mm
㊱  34PCS 2022*97*18mm	㊲  4PCS 1132*90*20mm	㊳  2PCS 1552*90*20mm	㊴  3PCS 1684*90*38mm	㊵  3PCS 1022*90*38mm

 10PCS 80*60*38mm	 12PCS 90*90*20mm	 1PCS 1550*33*13mm	 1PCS 1100*81*38mm	 1PCS 1100*70*38mm
 1PCS 1060*400*33mm	 3PCS 2022*90*38mm	 1PCS 1946*38*38mm	 1PCS 1162*90*38mm	 1PCS 1124*38*38mm
 3PCS 522*38*38mm	 2PCS 300*38*38mm	 2PCS 362*38*38mm	 2PCS 1100*67*38mm	 1PCS 820*40*20mm
 22PCS 1100*97*38mm	 1PCS 1060*90*38mm	 1PCS 1022*38*38mm	 42PCS 198*97*38mm	 2PCS 1100*55*38mm
 7PCS 1100*38*38mm	 9PCS 200*38*38mm	 1PCS 1764*544*6mm	 1PCS 1733*594*6mm	 1PCS 300*142*105MM
 Sauna light	 Sauna stove	 69PCS 1000*320*5mm		

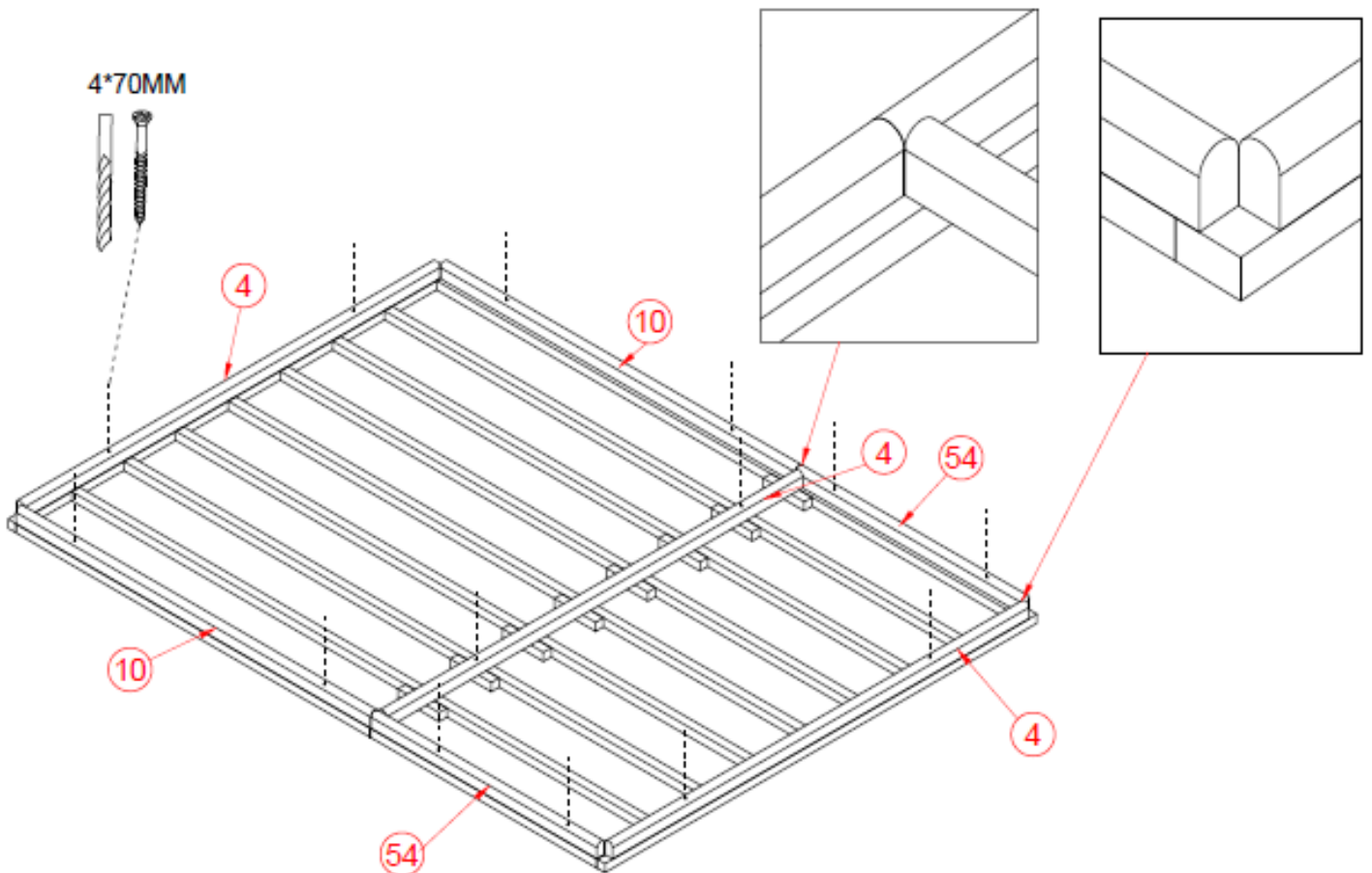
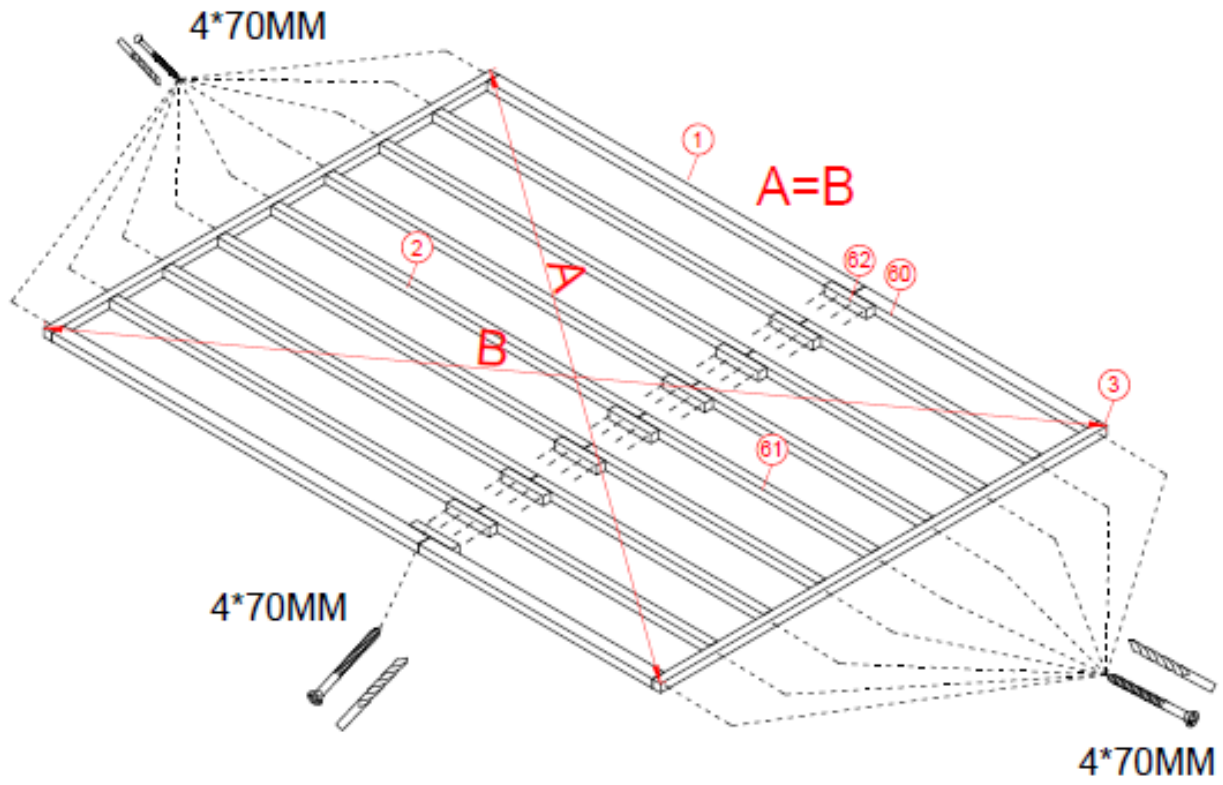

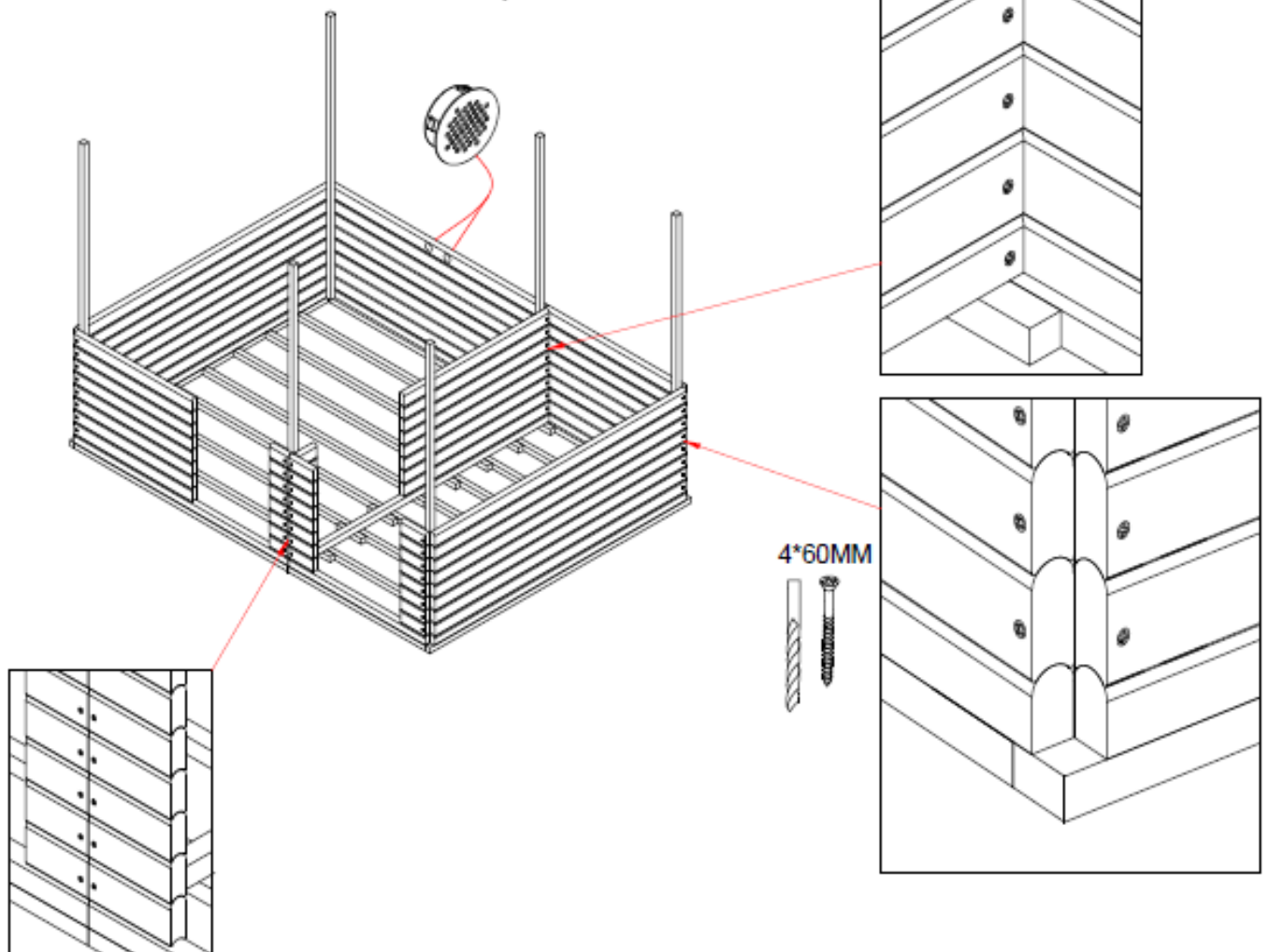
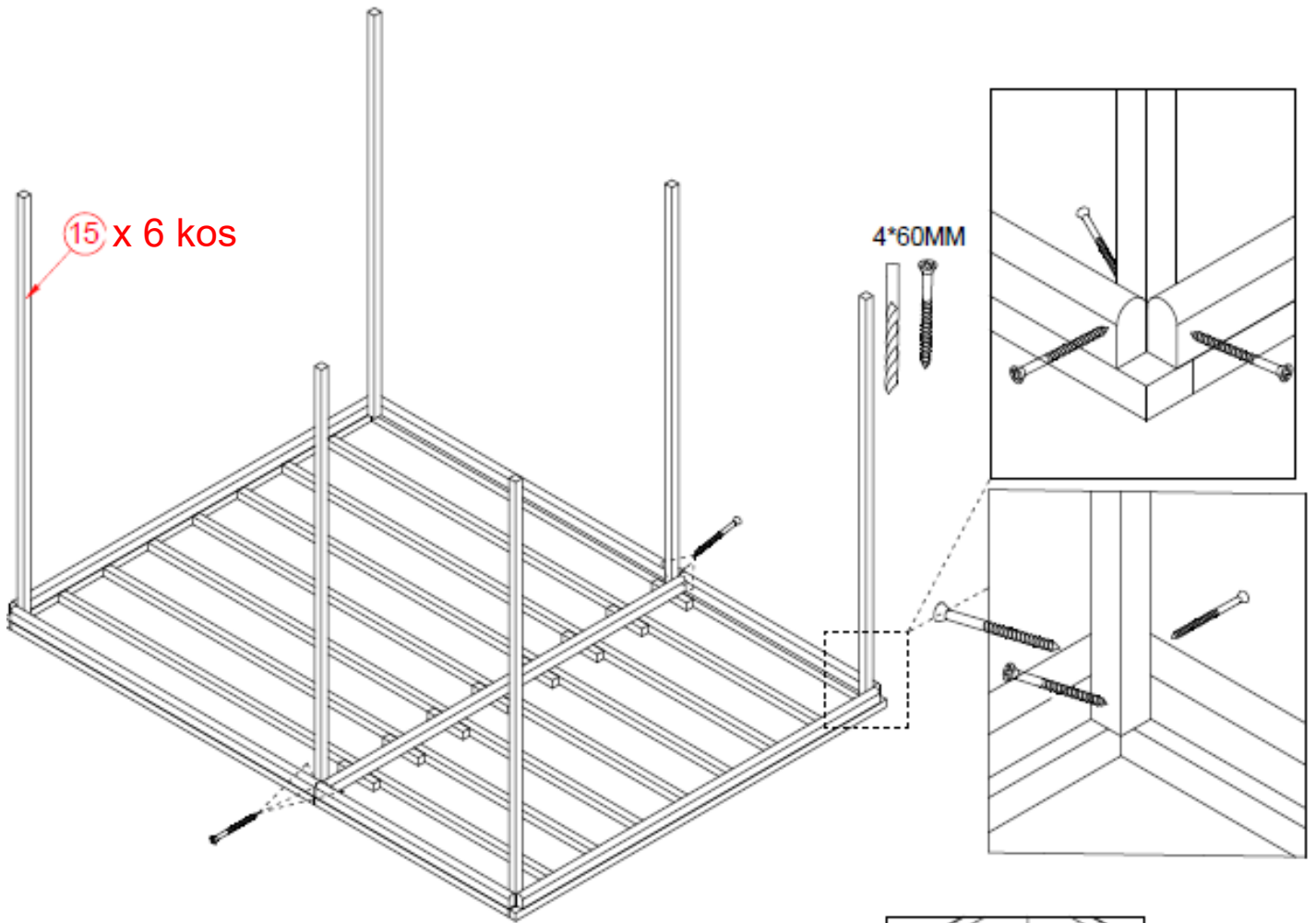

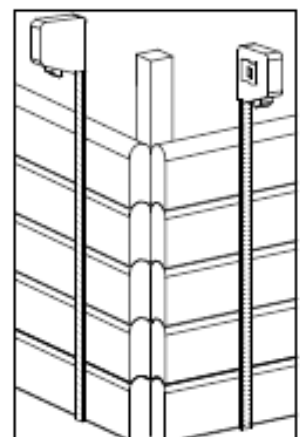
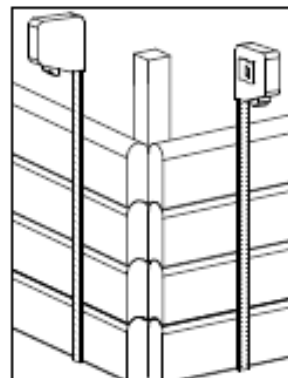
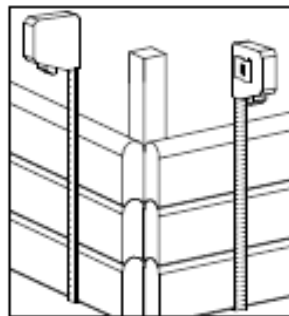
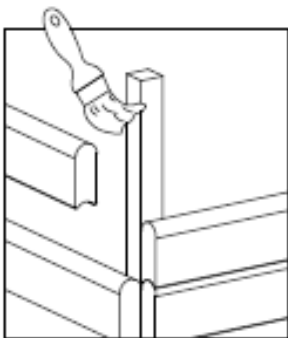
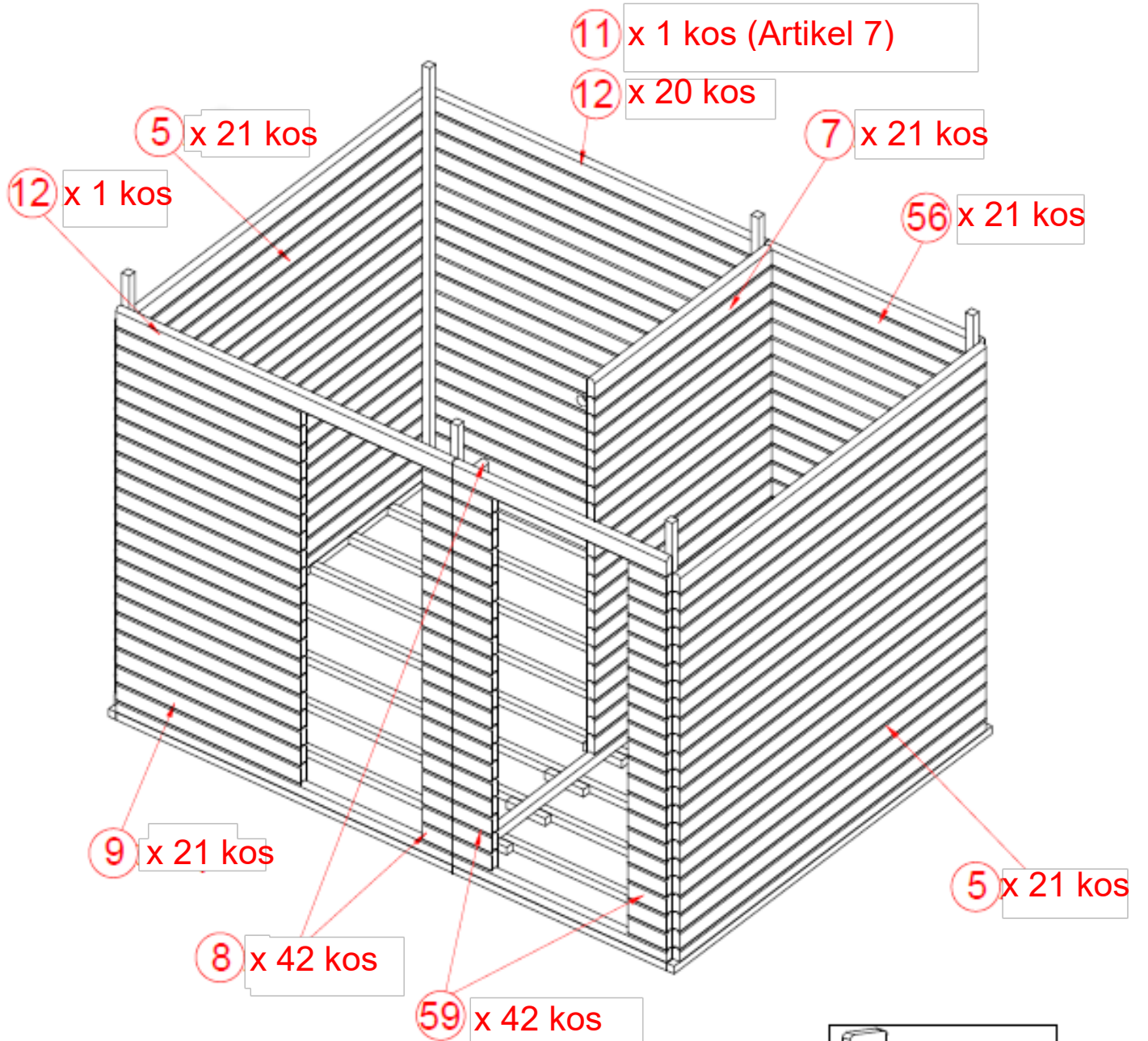

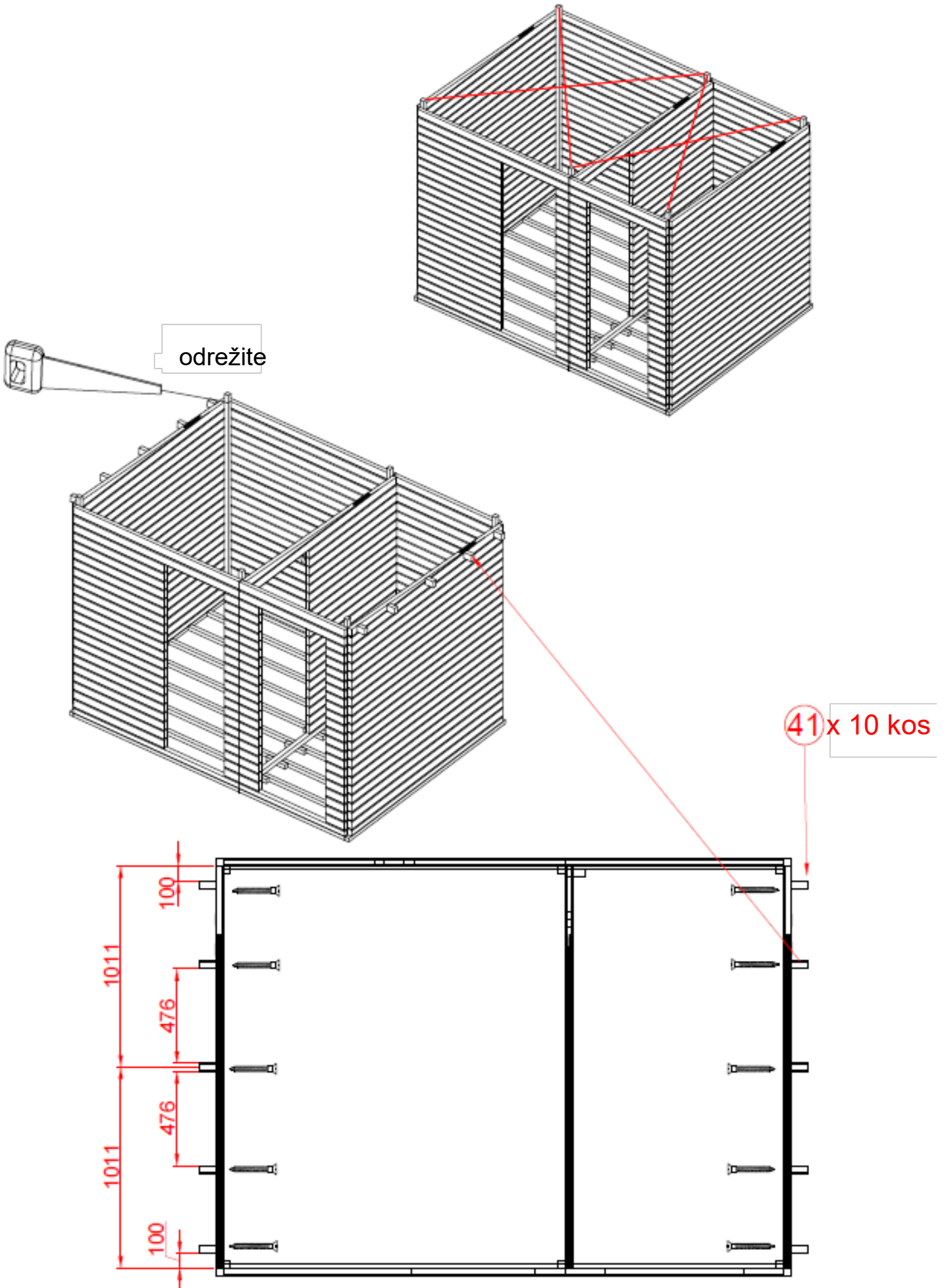

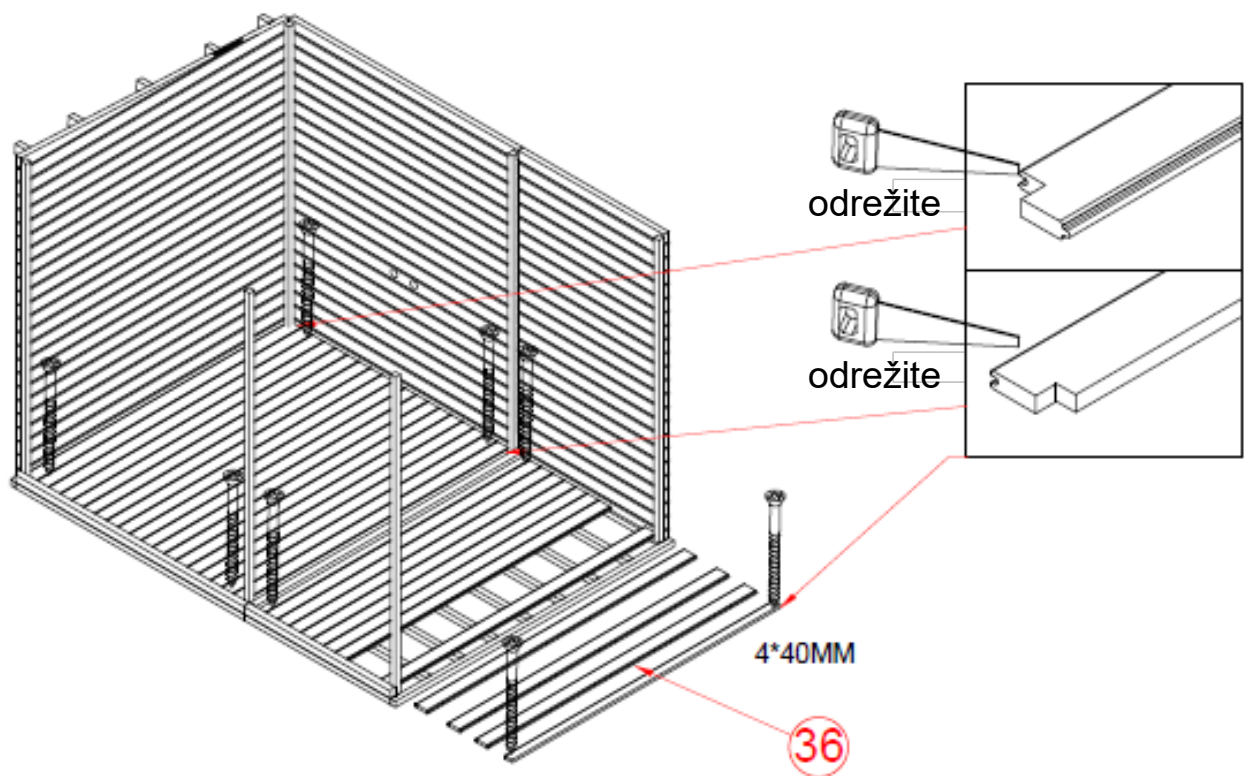
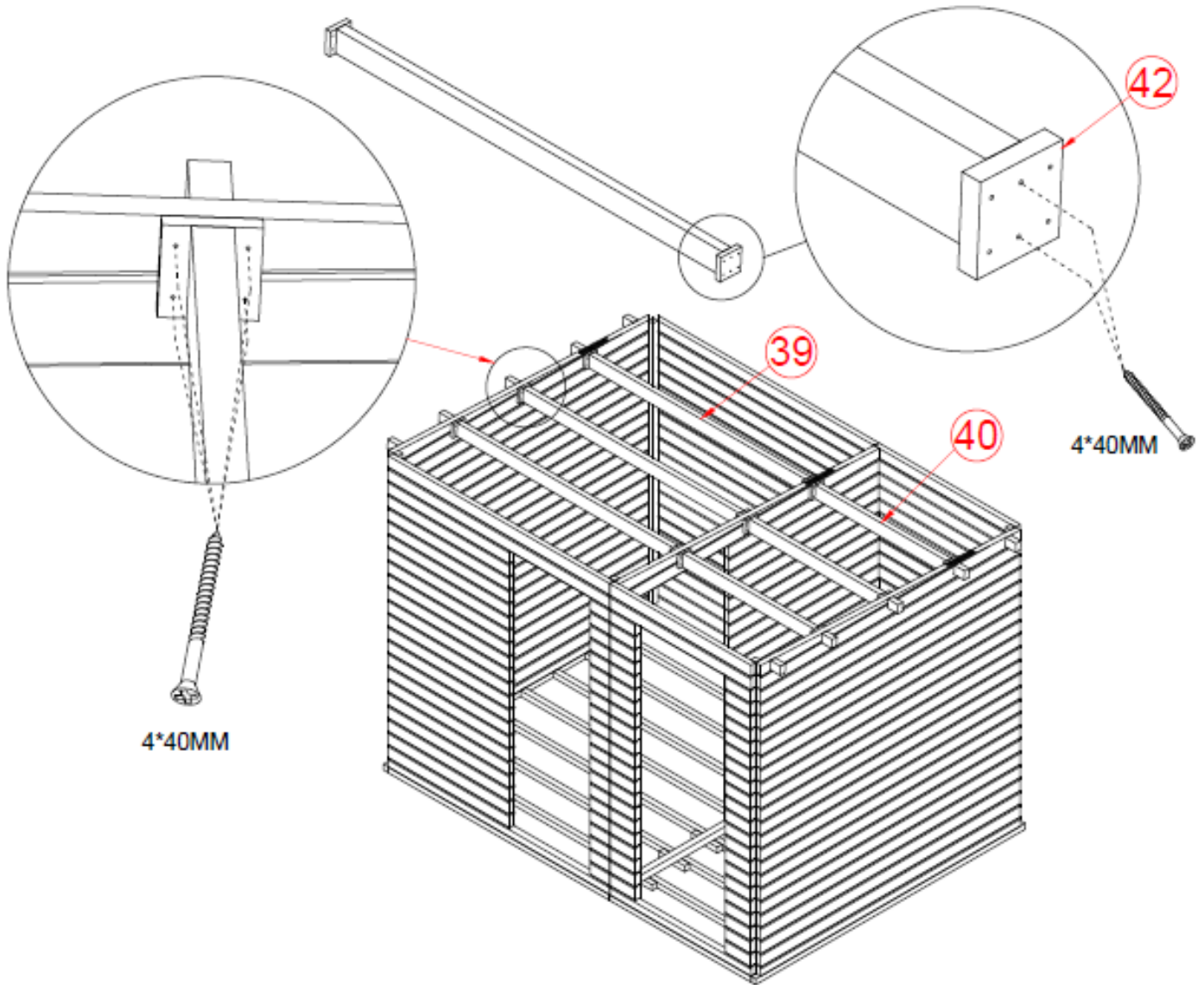

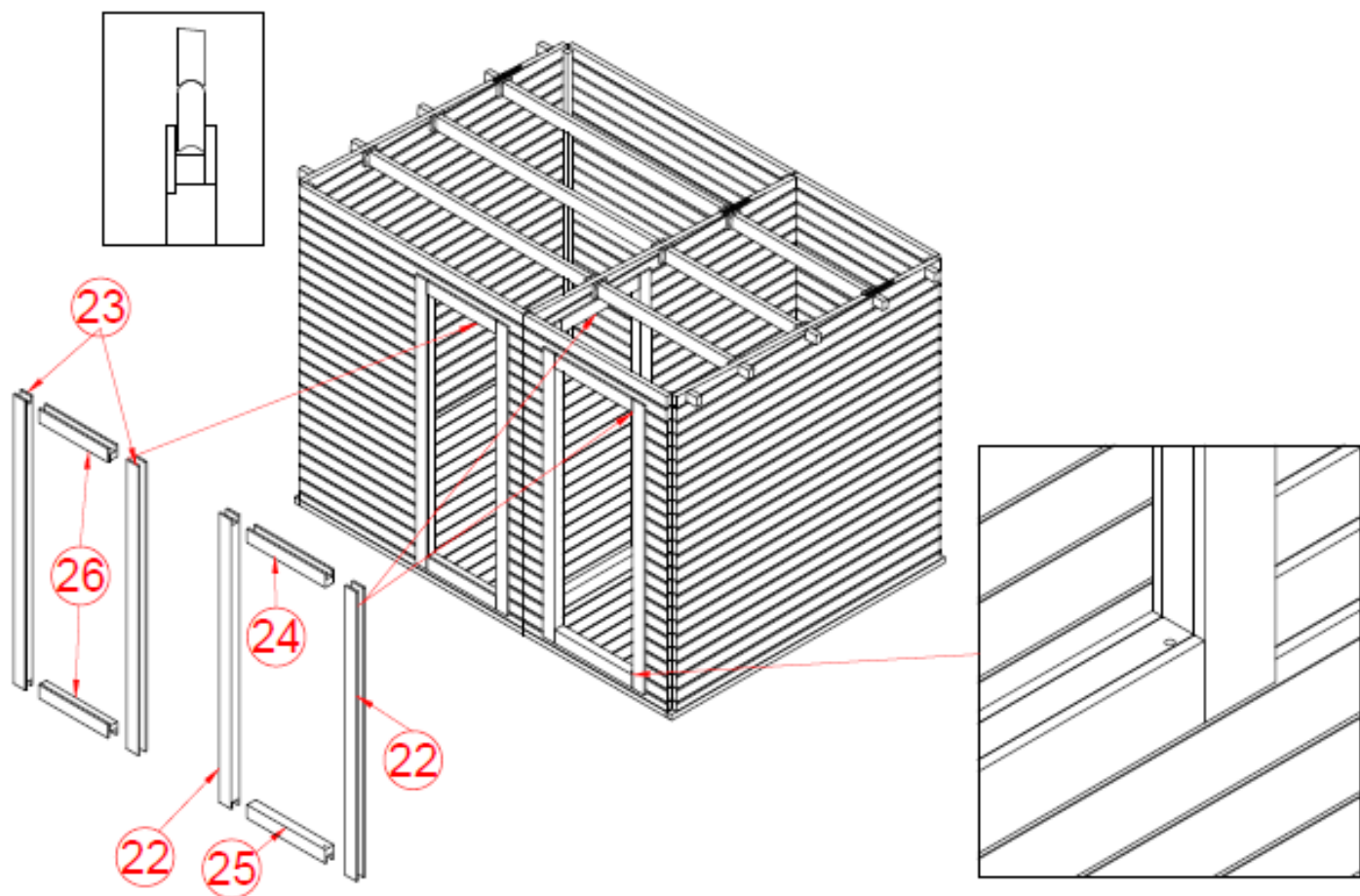
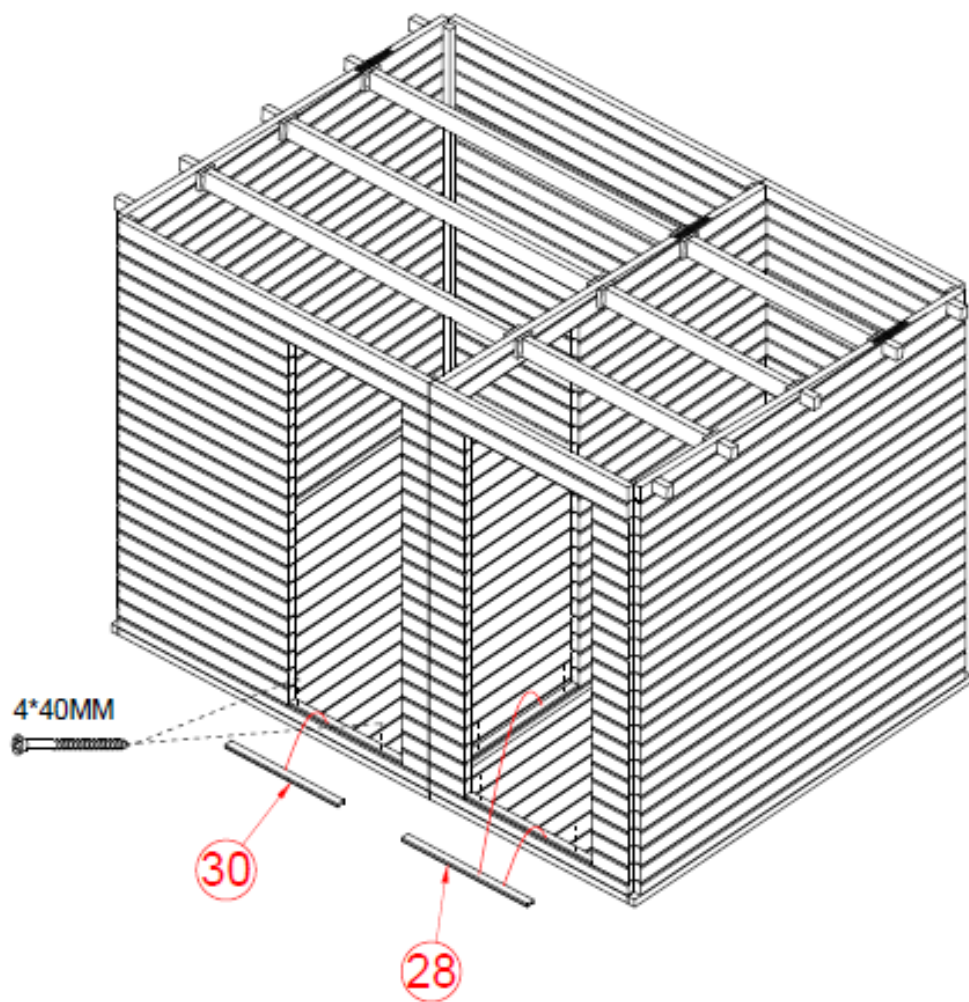

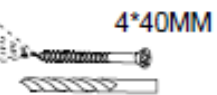
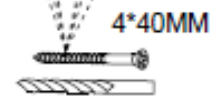
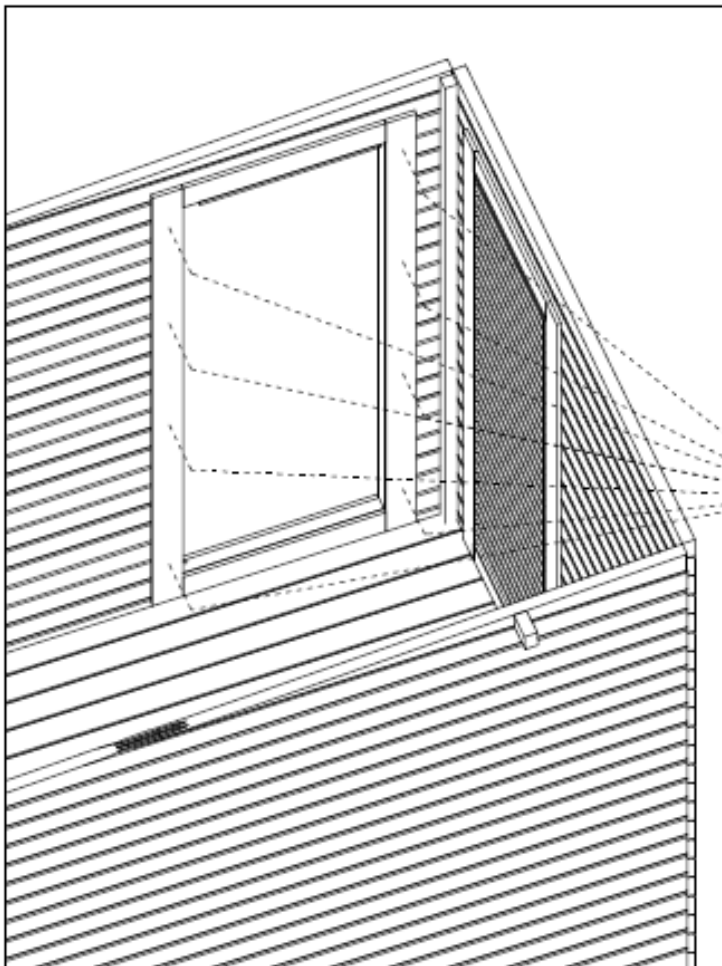
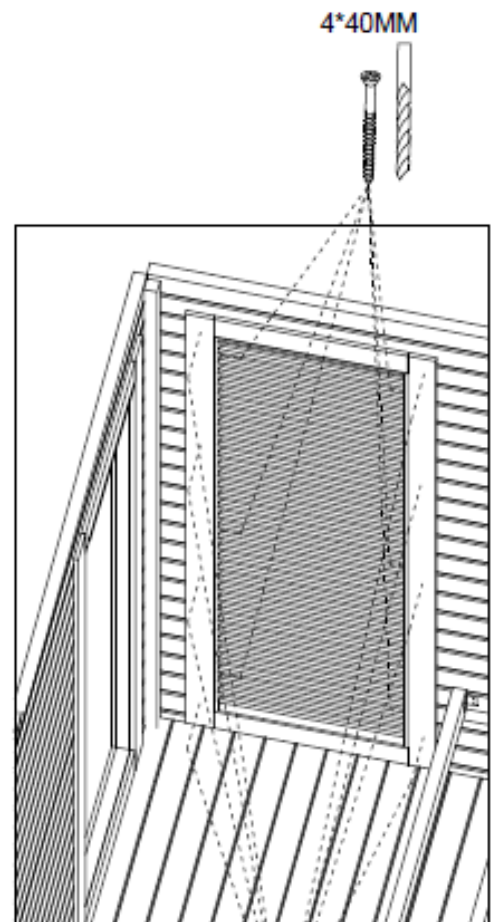
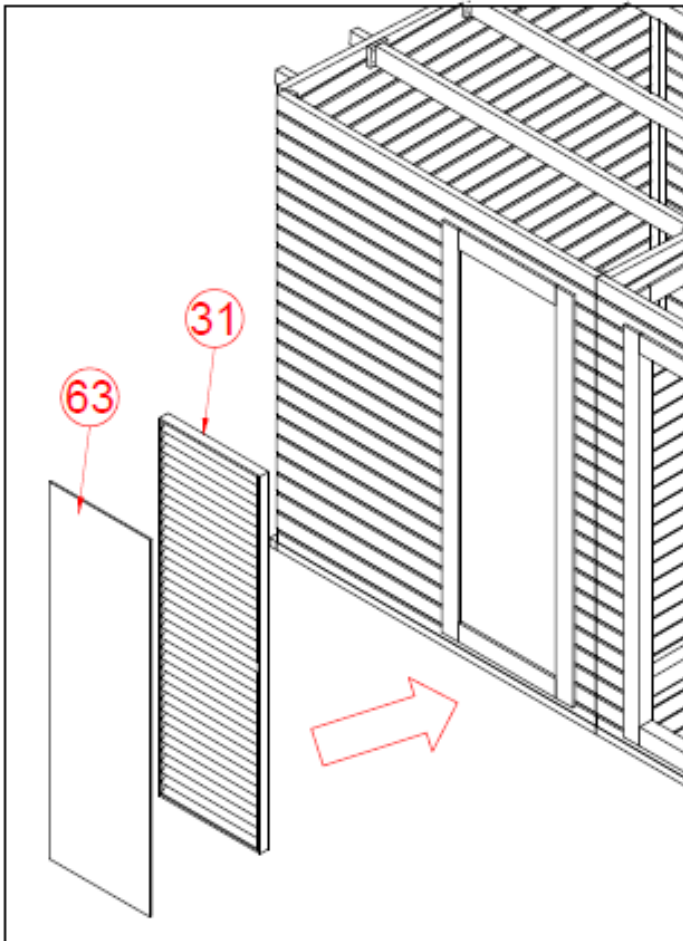

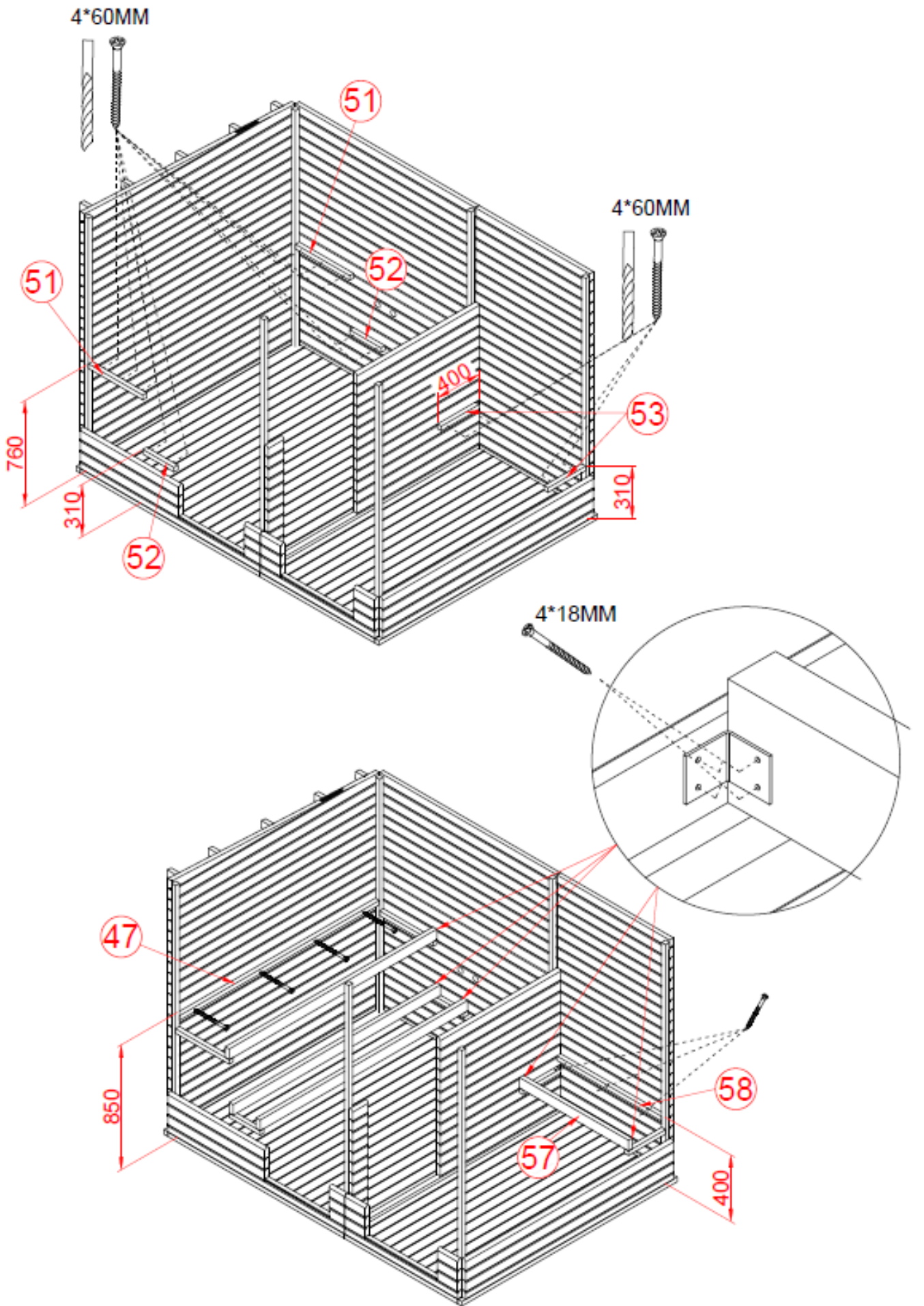

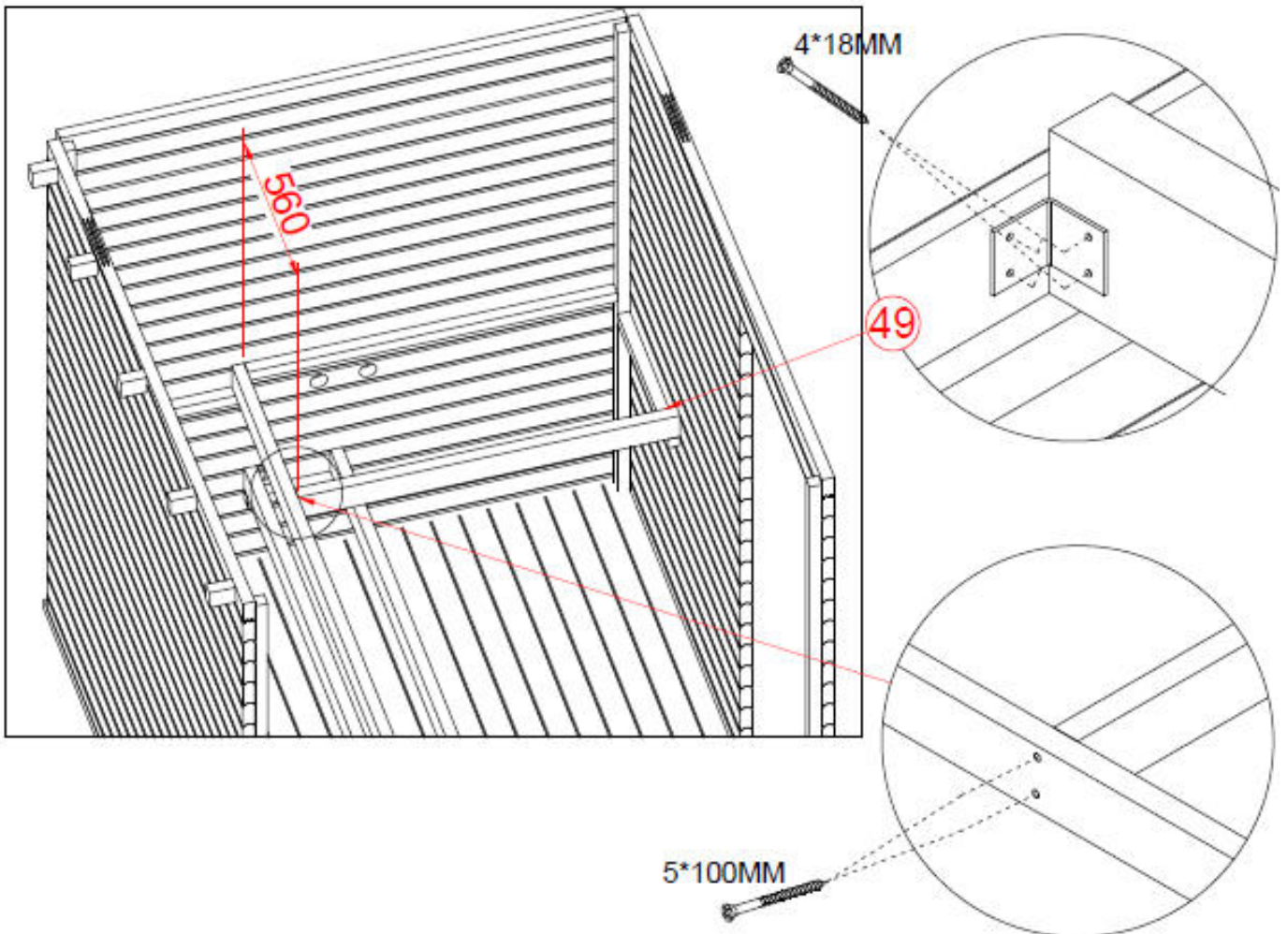
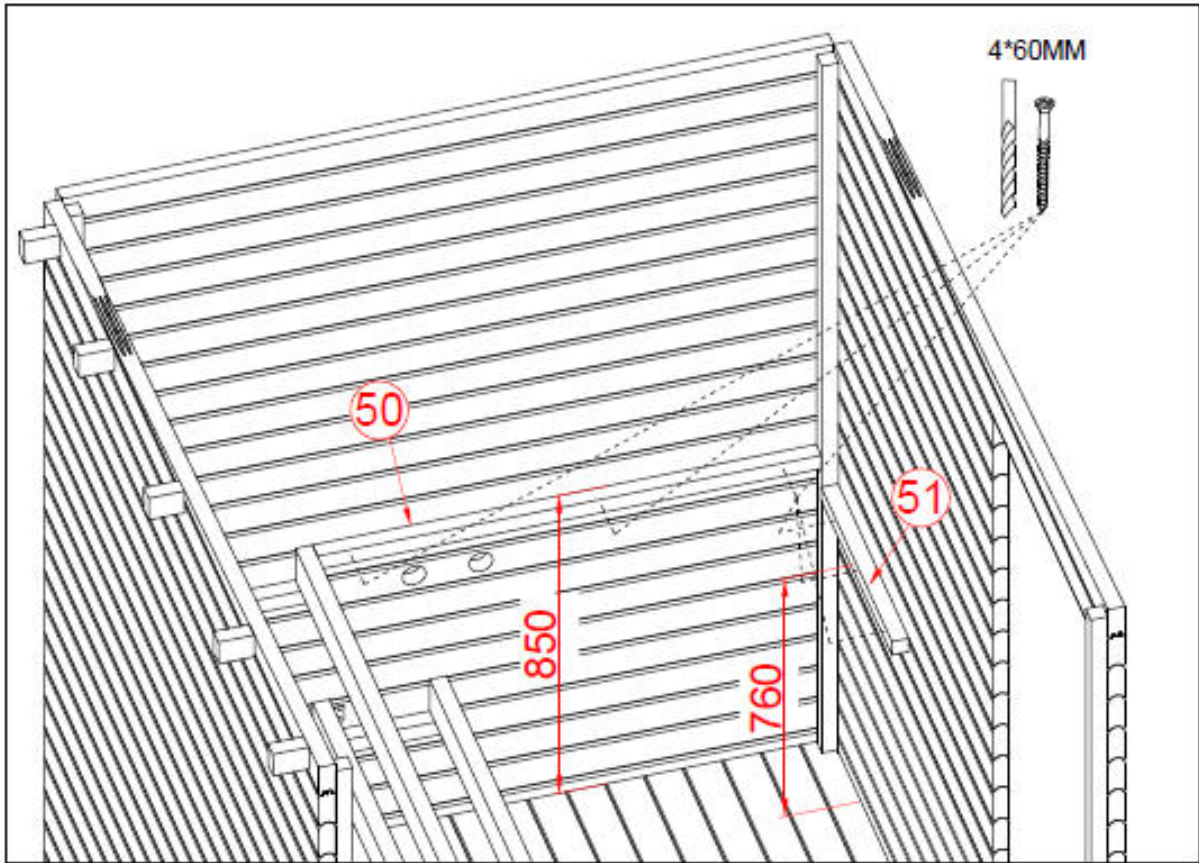

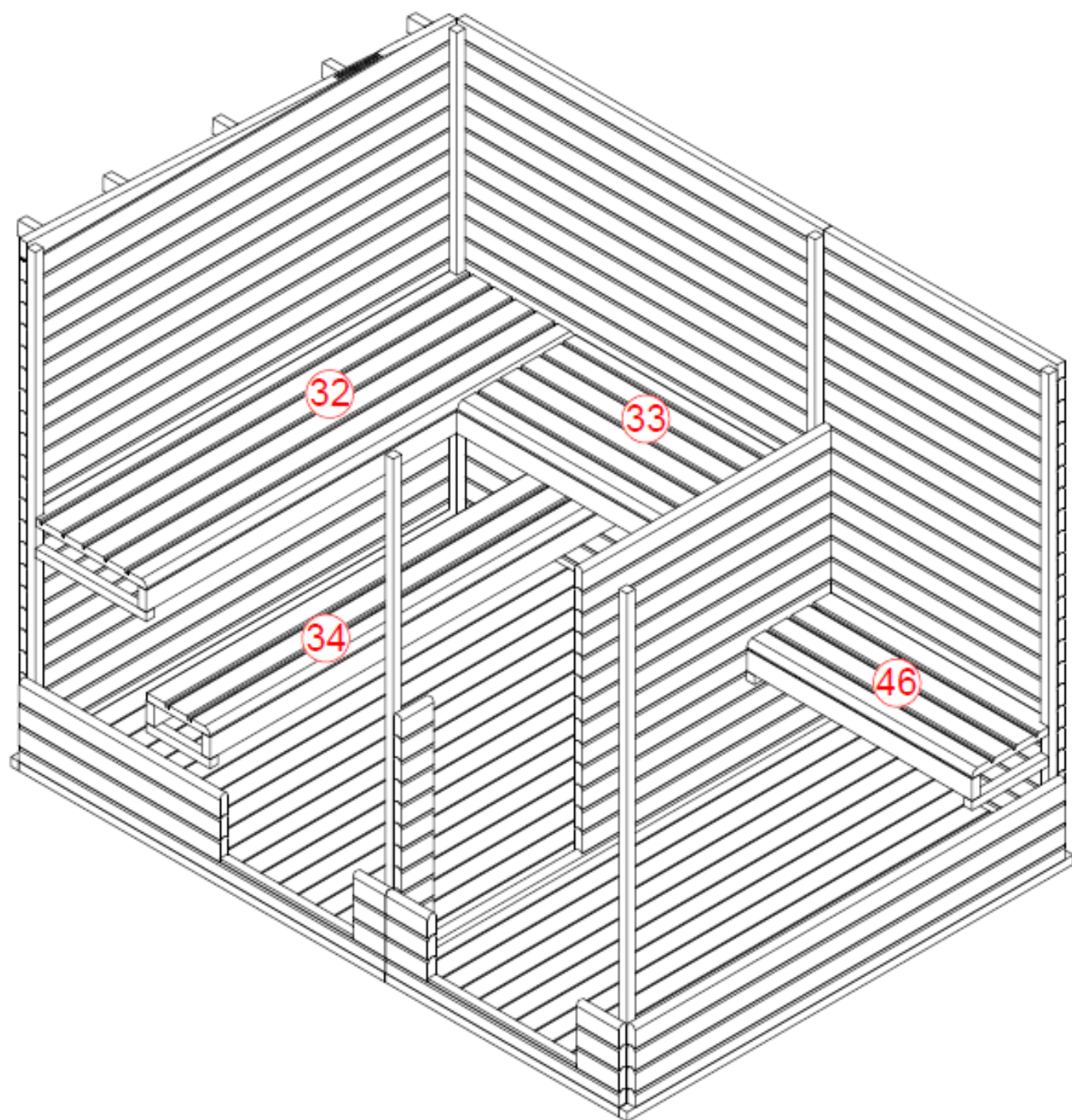

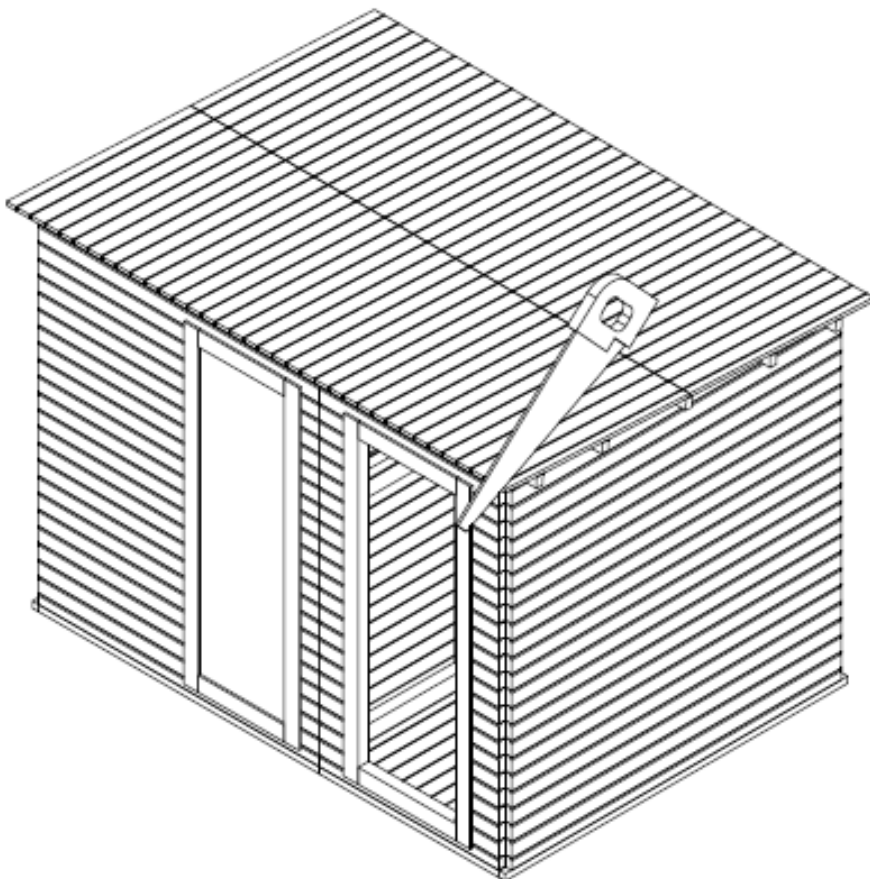
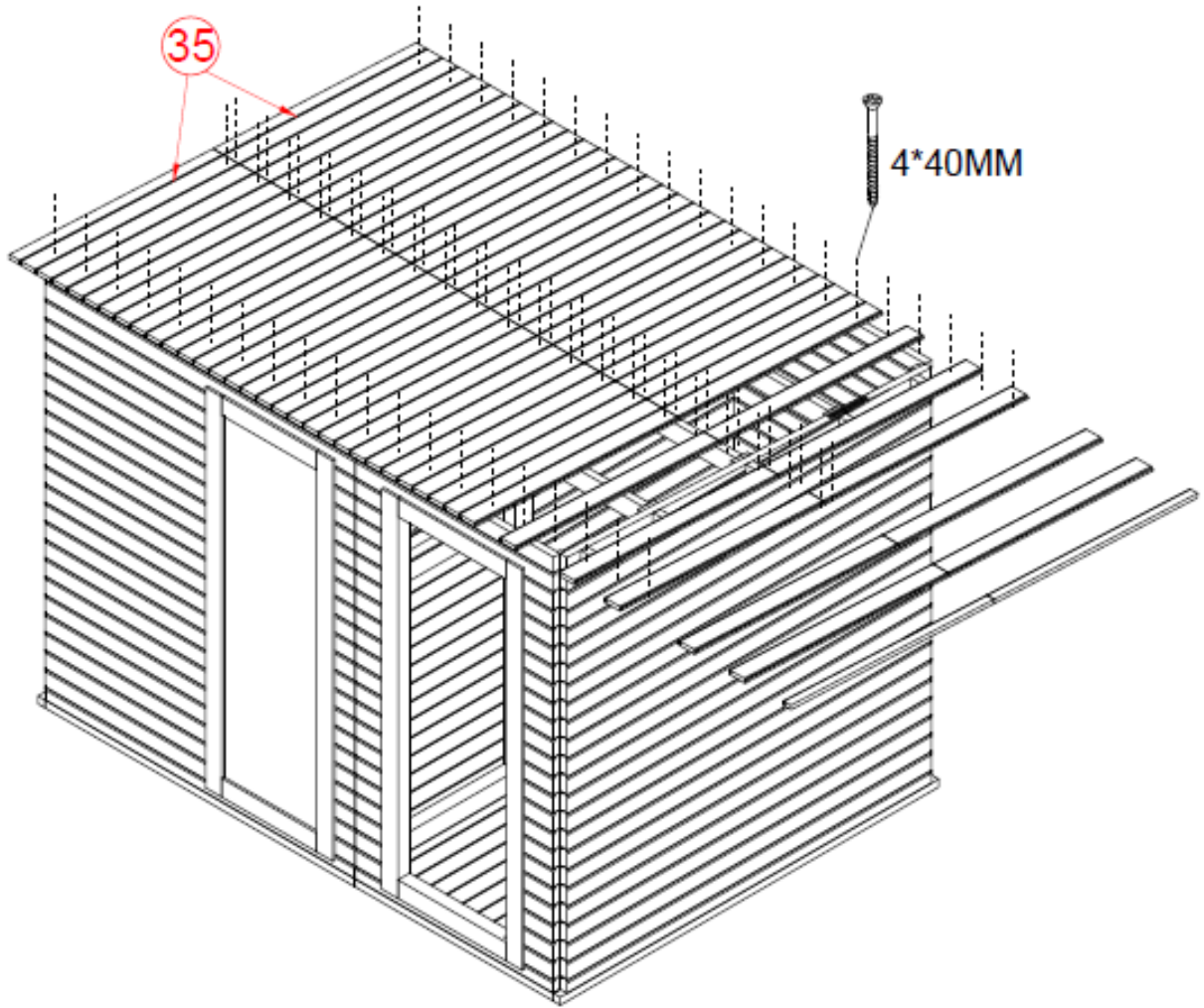

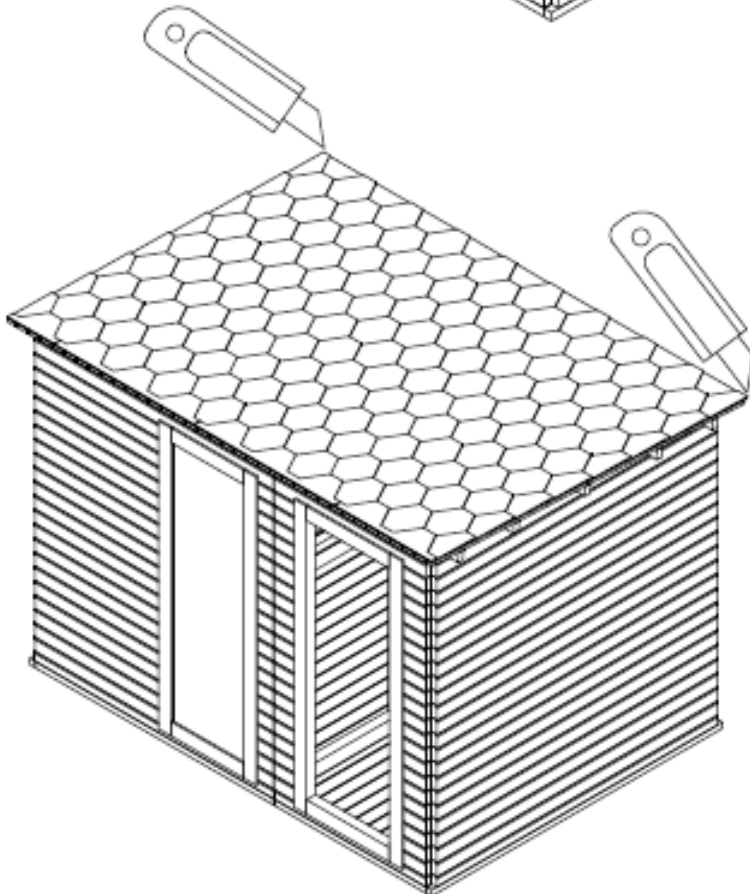
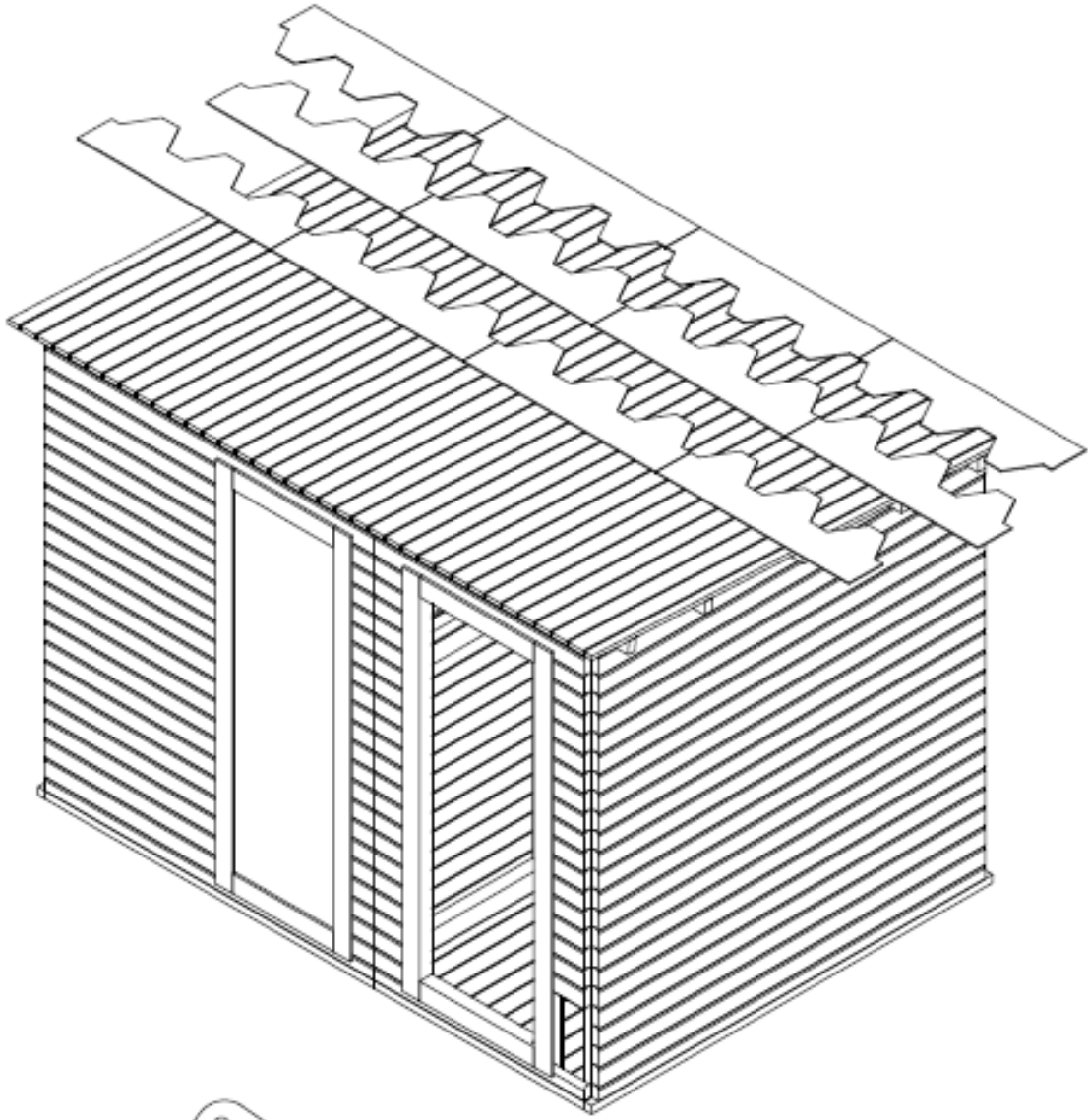

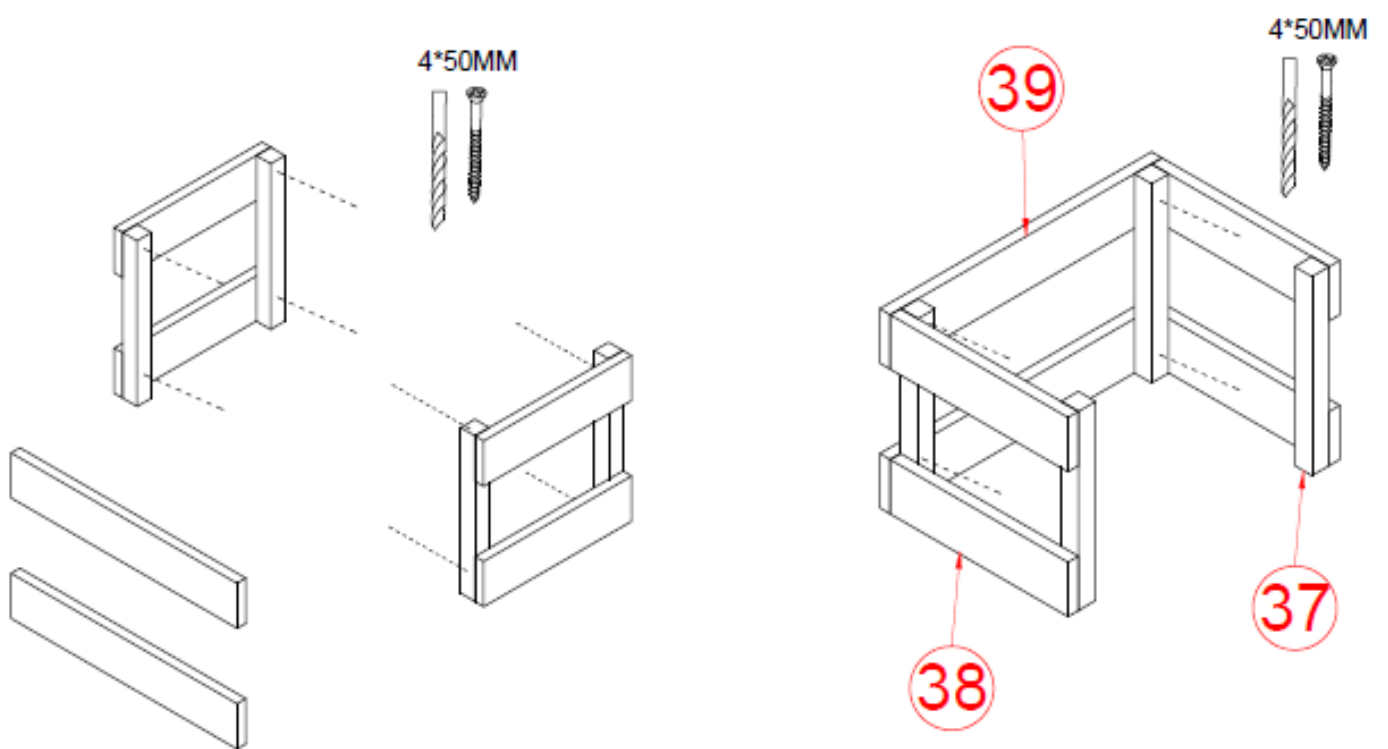
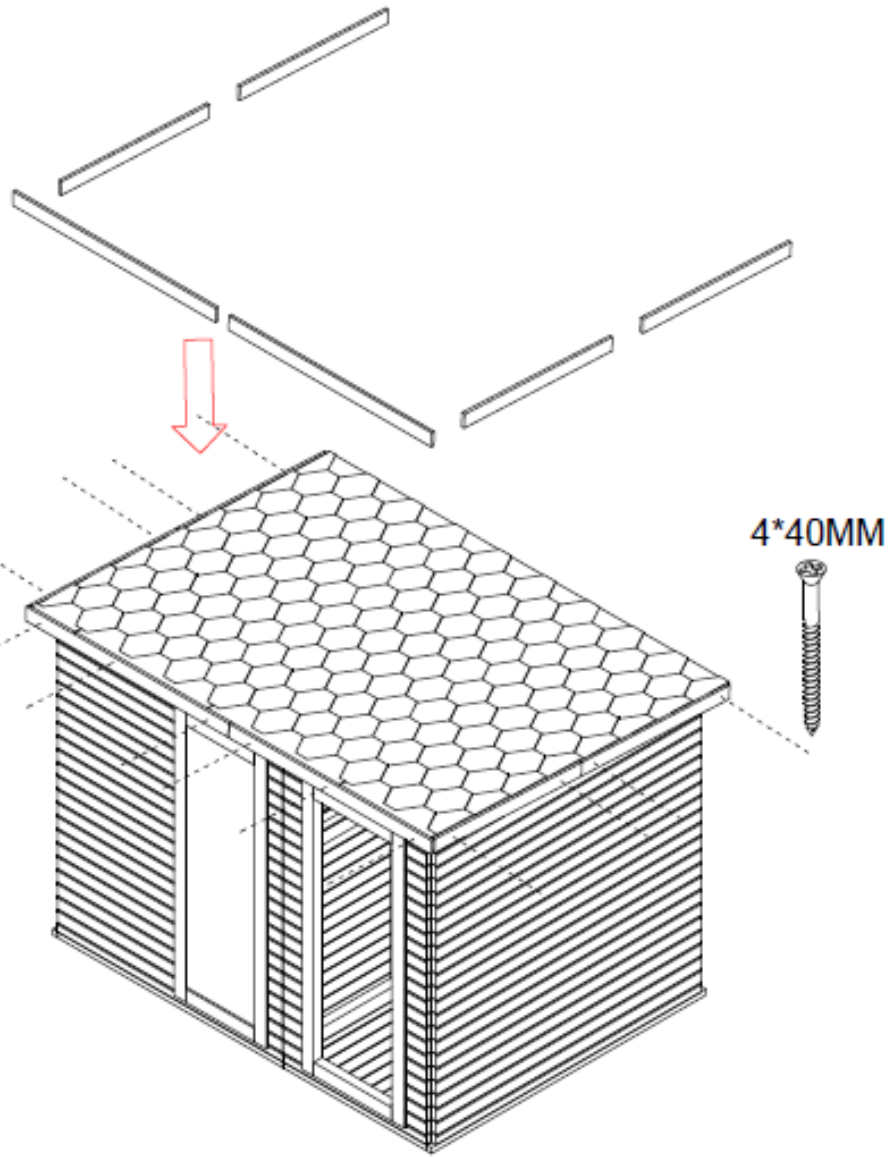

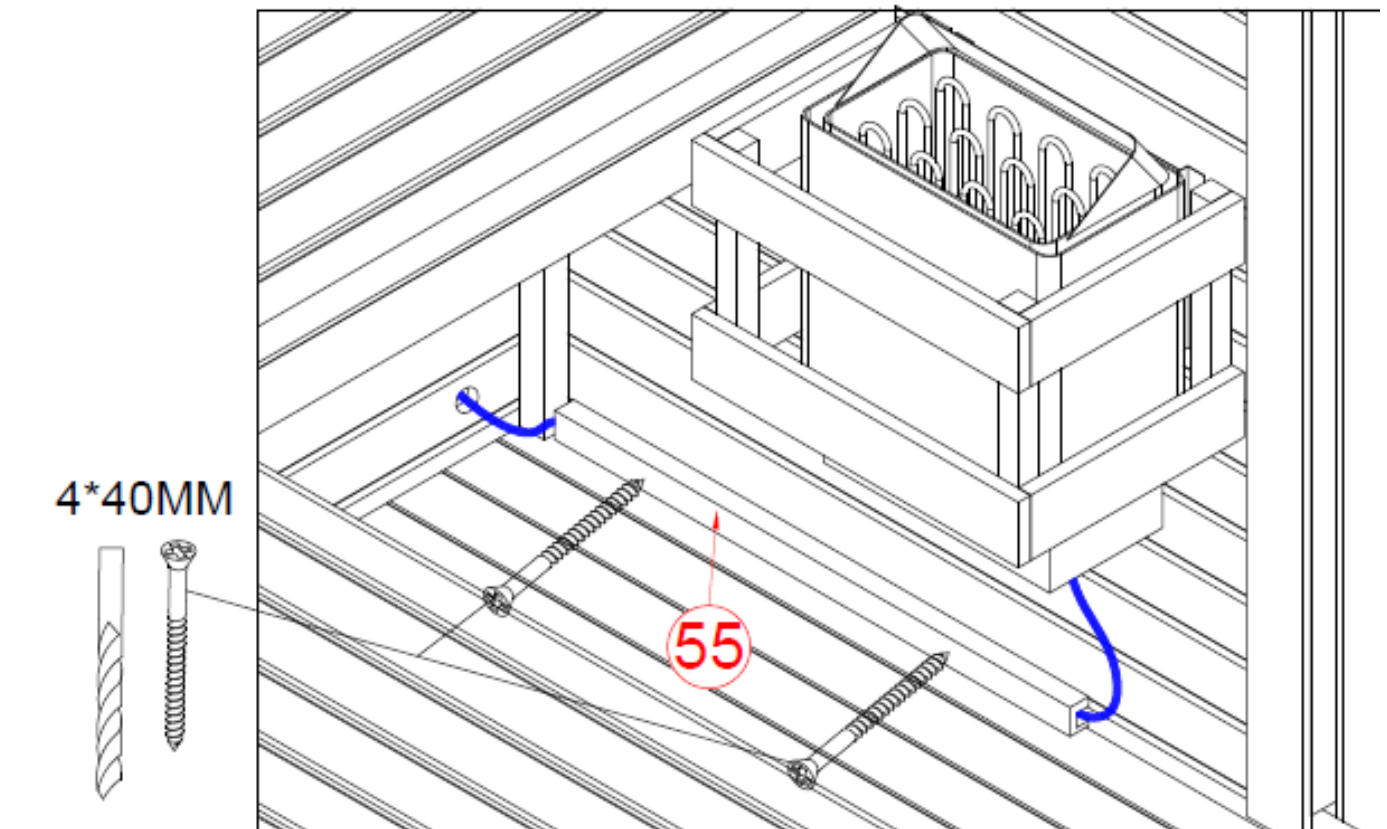
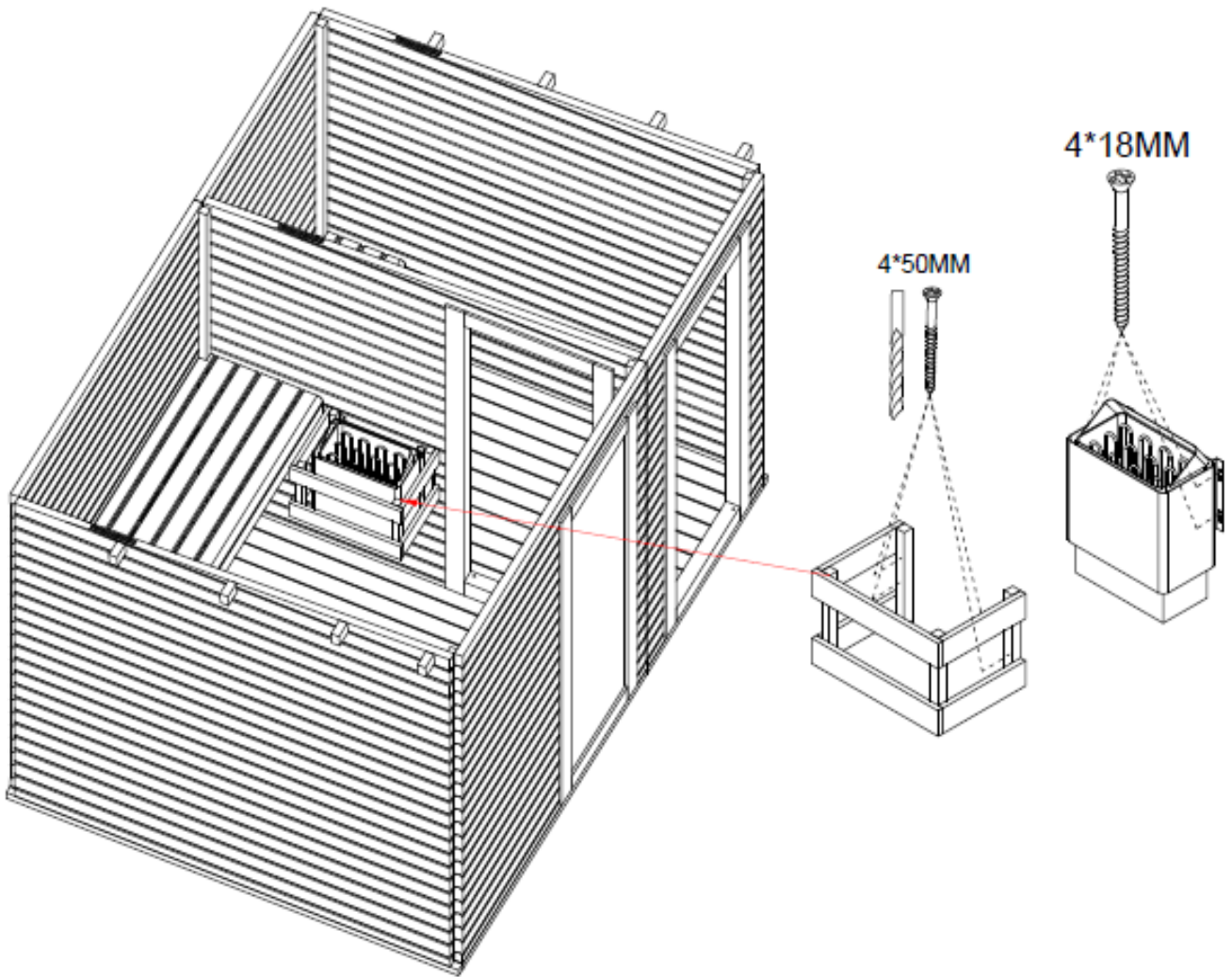

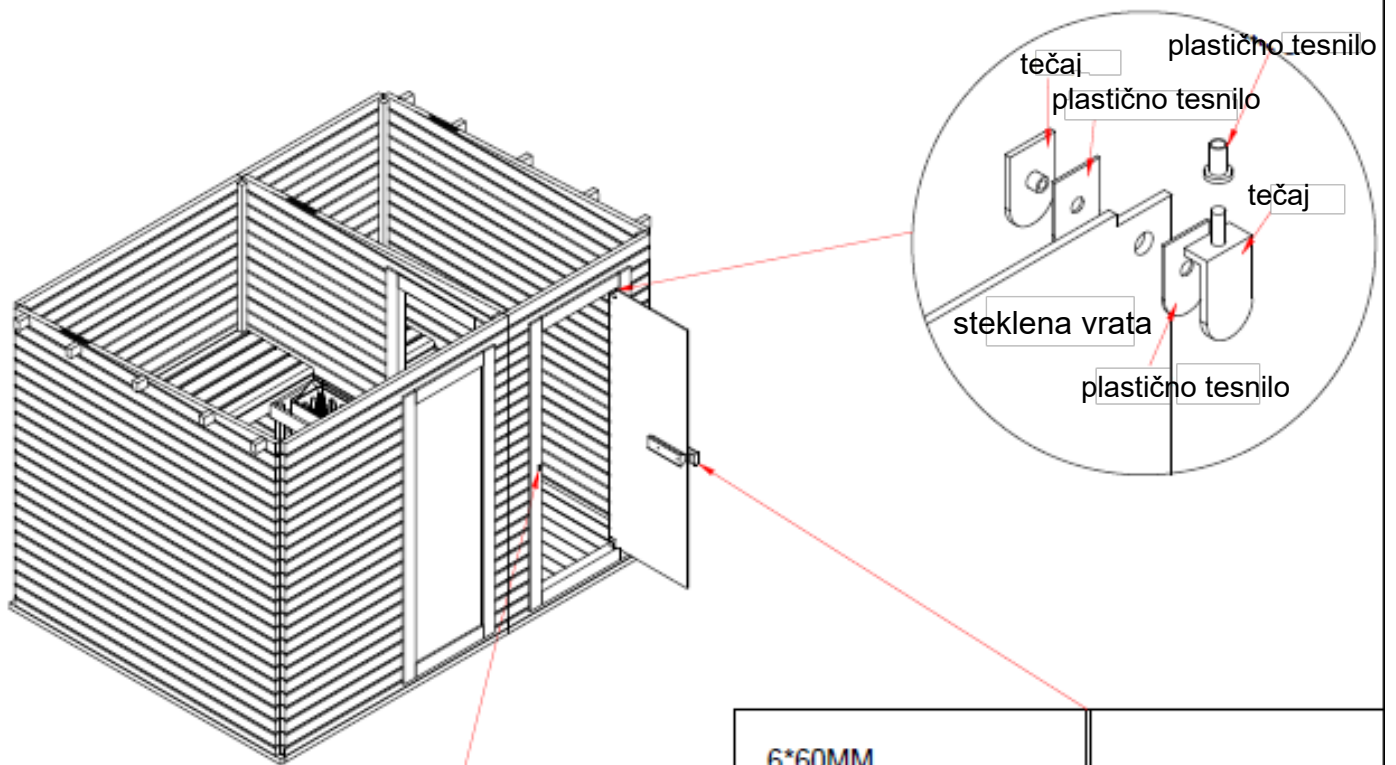
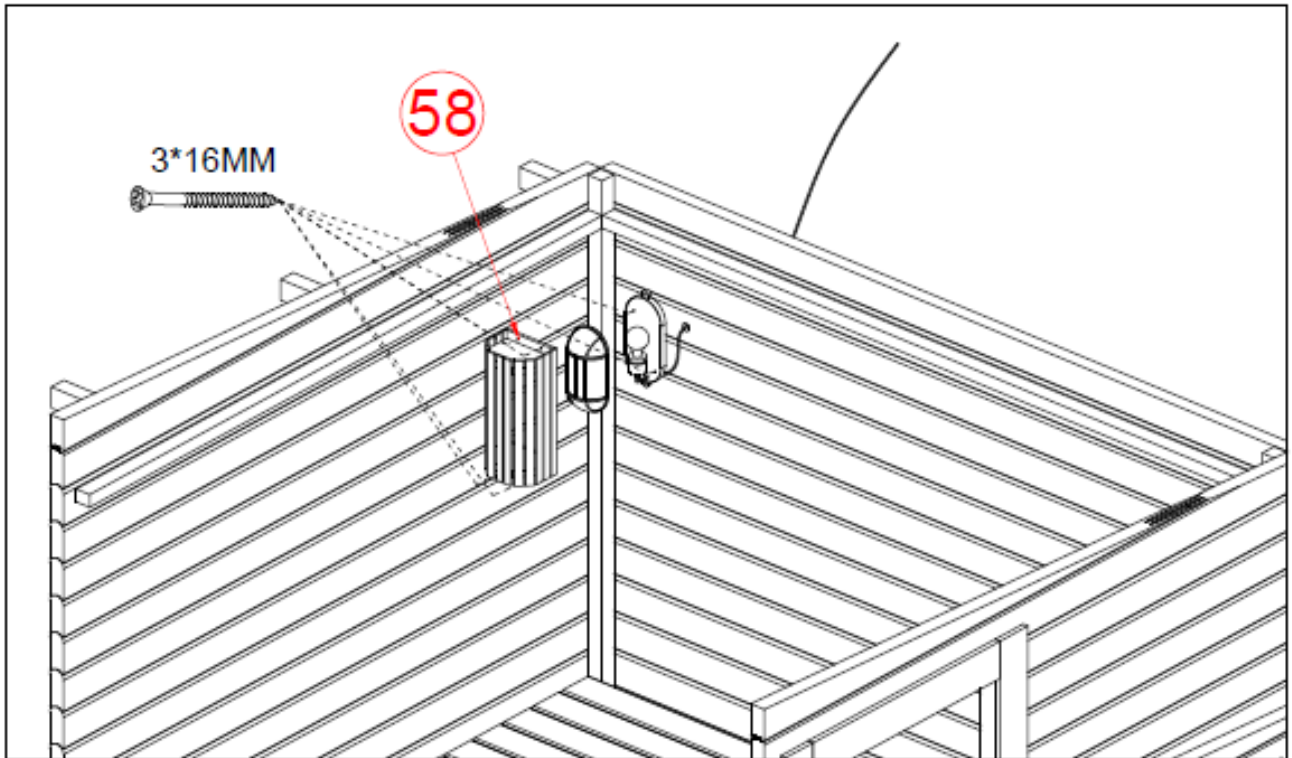

3*16MM

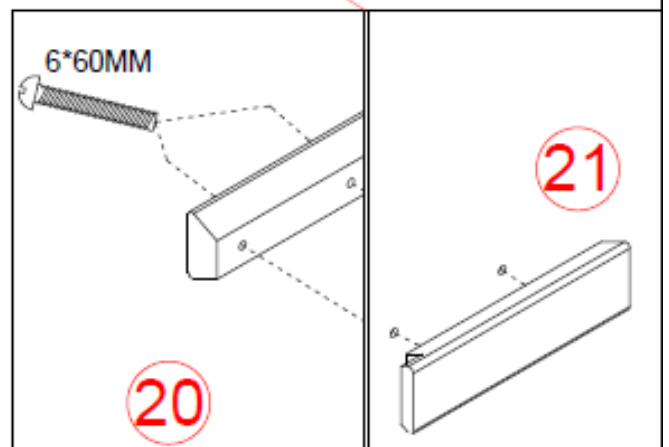

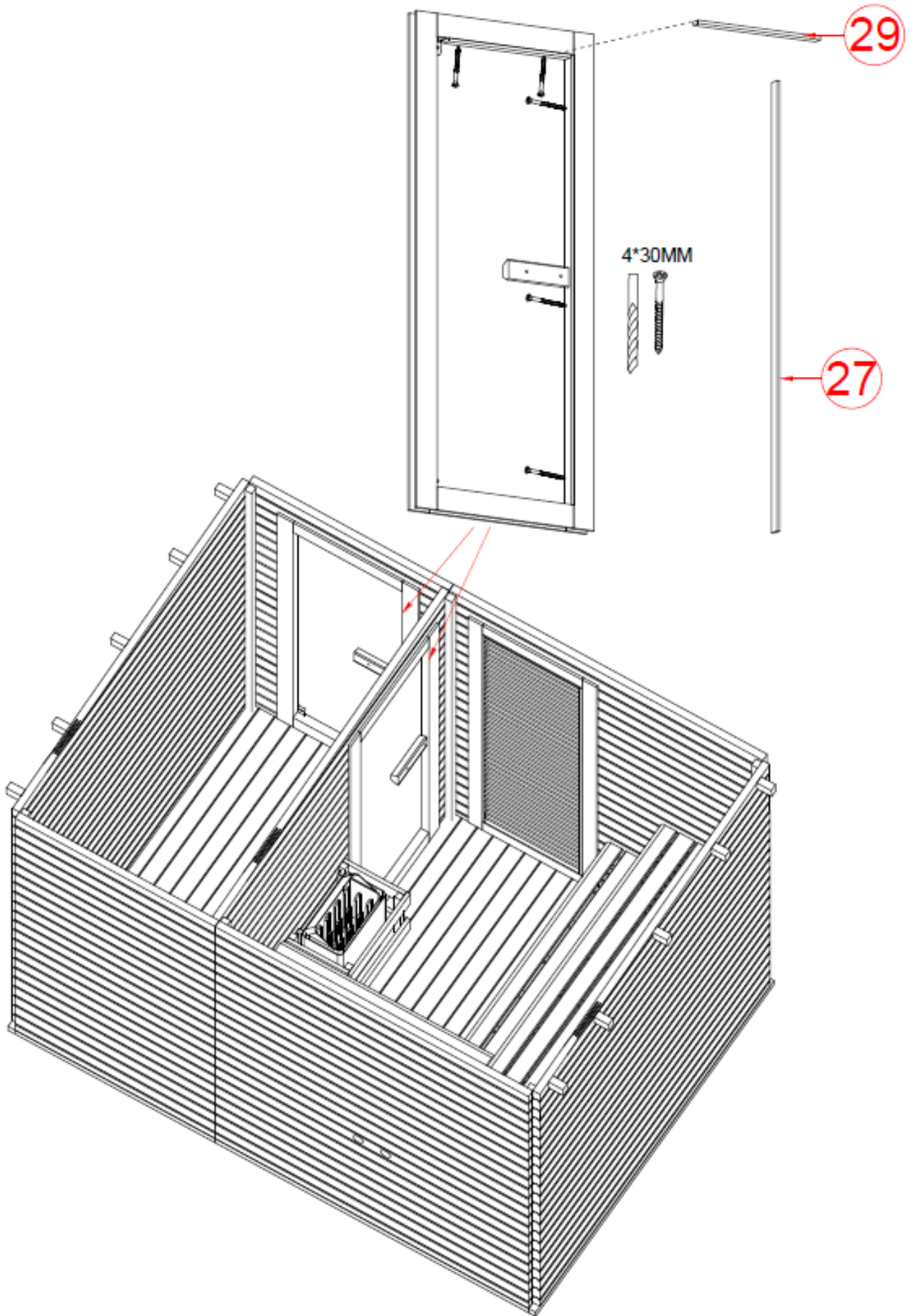

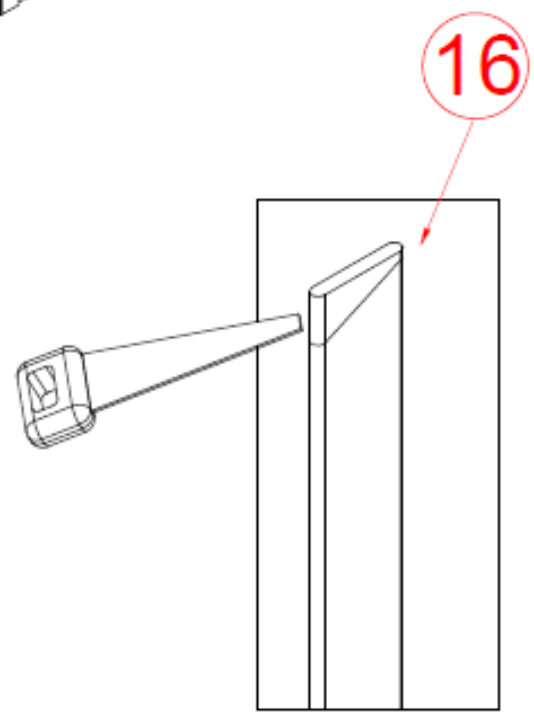
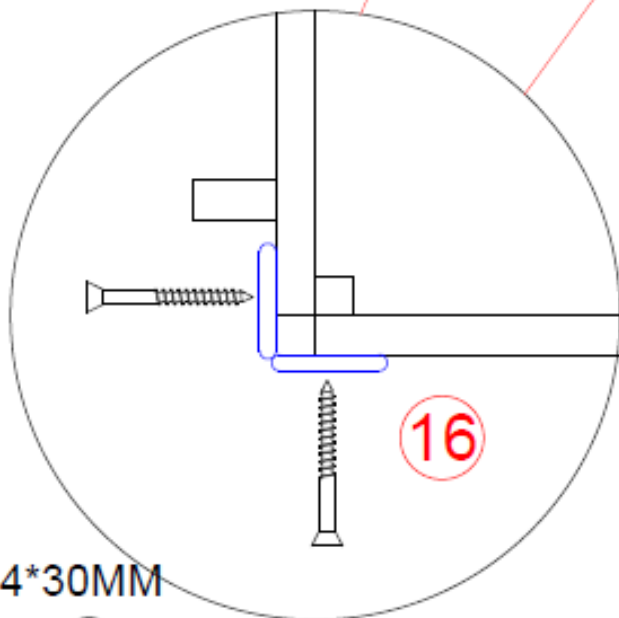
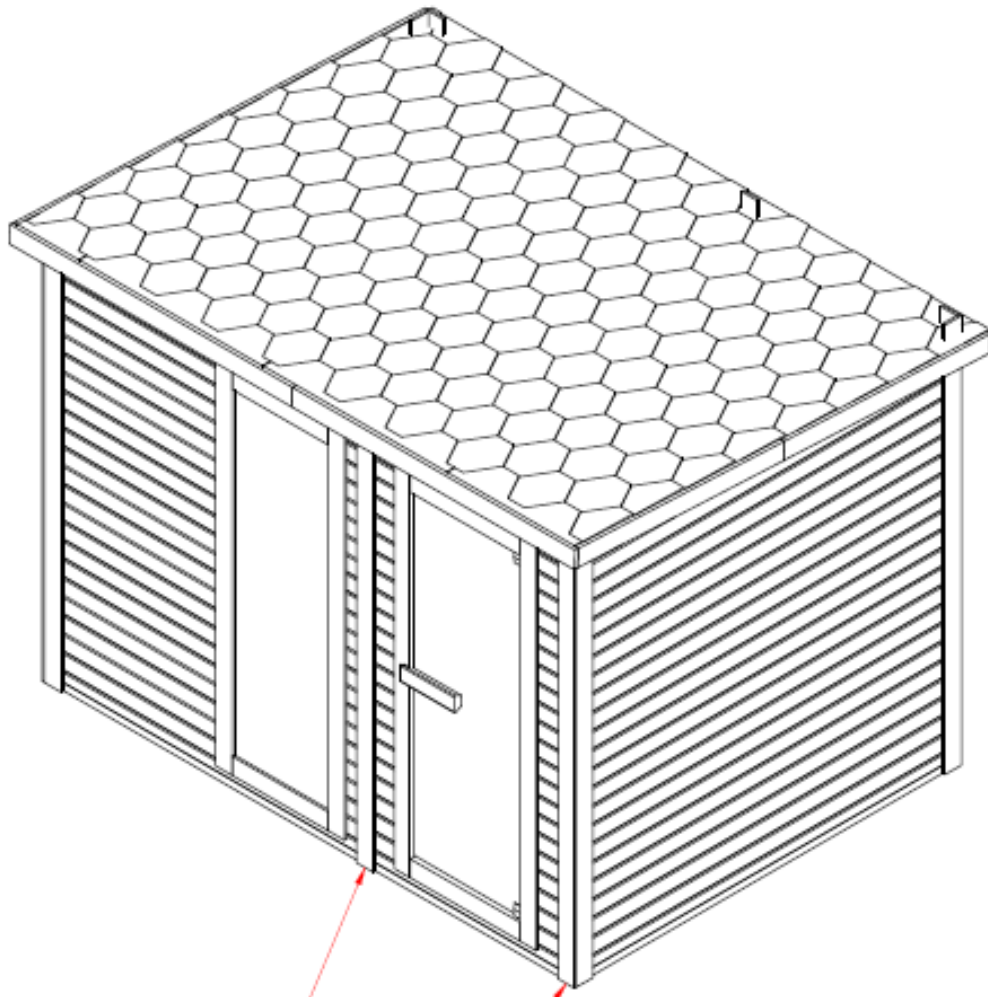

4*30MM

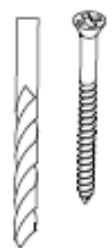

F30310

Upute za montažu

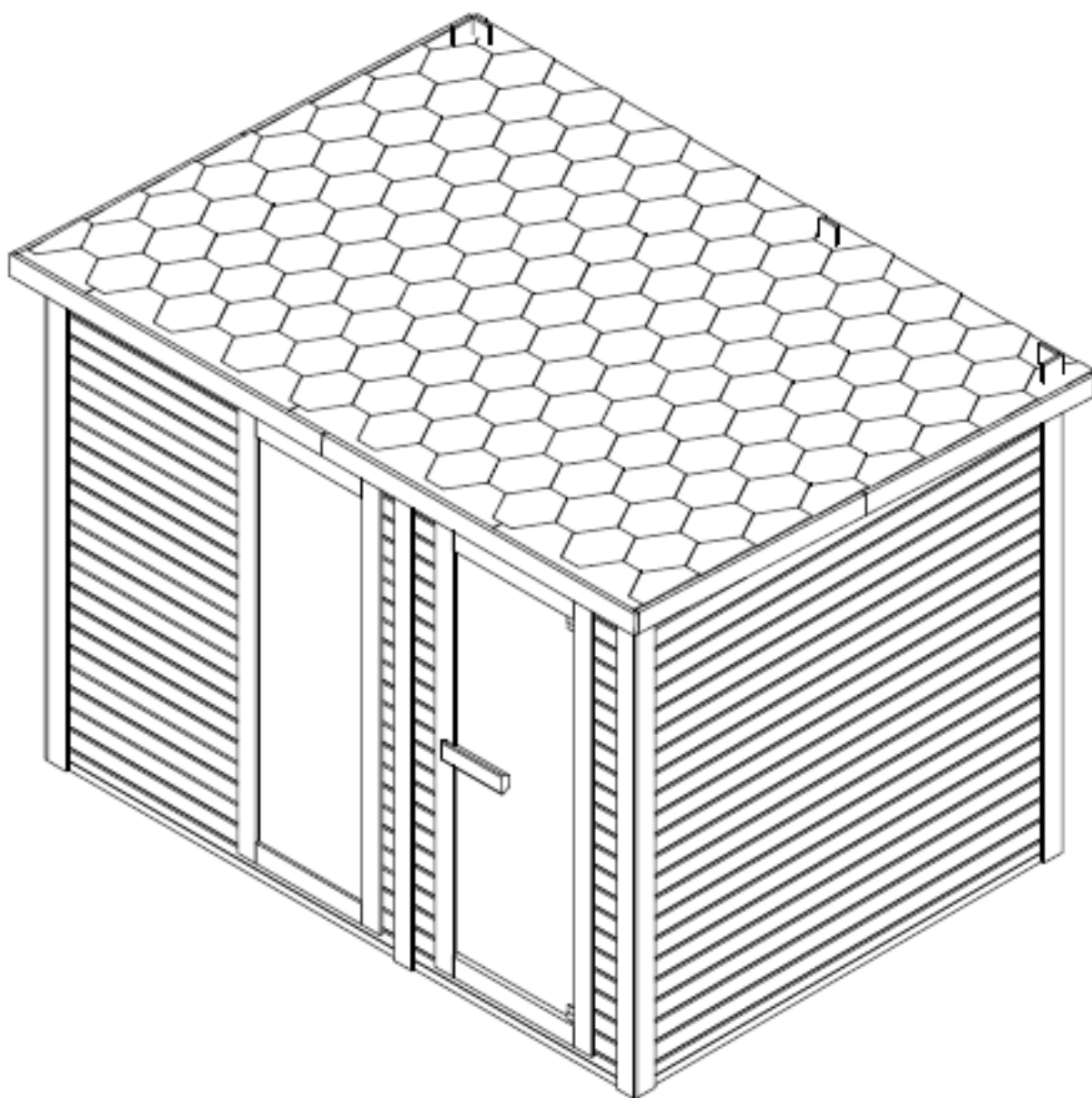

Preporuke

Pažljivo pročitajte ove upute prije prve uporabe saune.

Preporučamo da ih čuvate na sigurnom mjestu kako bi uvijek bili dostupni. Zabilježite serijski broj upravljačke ploče jer će vam trebati u slučaju popravaka ili naručivanja rezervnih dijelova.

- Drvo je živi element. Kako bi očuvalo izvorni izgled, drvo je potrebno zaštititi od vlage izvana.
- Postavite saunu na potpuno ravnu i tvrdu podlogu.
- Ne koristite tekuća agresivna sredstva za čišćenje. Prije čišćenja isključite saunu i koristite samo vlažnu krpu.
- Zaštitite električni kabel saune od gnječenja ili prignječenja.
- Prije zamjene određenih komponenti provjerite jesu li navedene od strane proizvođača ili imaju li iste karakteristike kao originalni dijelovi. Nepravilna zamjena može uzrokovati požar, kratki spoj ili oštećenje saune. Preporučujemo da se obratite kvalificiranom tehničaru.
- Kako biste izbjegli rizik od opekline ili strujnog udara, nemojte koristiti metalne alate.
- Nije dopušteno dovoditi životinje u saunu.
- Ne ostavljajte saunu uključenu bez nadzora.
- Ne ostavljajte saunu uključenu dulje od 3 sata kako biste izbjegli prerano oštećenje uređaja. Nakon 3 sata neprekidnog rada isključite saunu najmanje jedan sat.
- Ne preporučuje se ugradnja sustava zaključavanja na vrata saune.
- Prije spajanja saune na električnu mrežu, provjerite ispunjava li vaša električna instalacija zahtjeve.
- Montažu i popravke smije izvoditi samo kvalificirani električar!
- Koristite samo originalne dijelove.
- Isključite saunu kada je ne koristite.

OPASNOST

- Prekrivanje peći stvara opasnost od požara zbog pregrijavanja. Nemojte preklapati grijaće elemente!
- Zapaljive materijale i predmete (npr. ručnike) uvijek držite dalje od grijaćih tijela.
- Ne dirajte peć za saunu tijekom ili ubrzo nakon upotrebe jer postoji opasnost od opekline od vrućih dijelova.
- Žarulja se zagrijava tijekom rada. Ako žarulju treba zamijeniti, isključite saunu i pustite da se žarulja ohladi prije nego što je zamijenite.

Sigurnosne informacije

VAŽNO!

Pažljivo pročitajte sigurnosne upute prije postavljanja i korištenja saune. Oni su ključni za vašu sigurnost, pa ih se pažljivo pridržavajte.

Čuvajte se hipertemije, toplinskog udara ili toplinske iscrpljenosti, koji mogu biti uzrokovani ili pogoršani ako se ne slijede sigurnosne upute. Simptomi uključuju vrućicu, ubrzan puls, vrtoglavicu, nesvjesticu, letargiju i obamrlost cijelog tijela ili njegovih dijelova. Posljedice su: smanjena percepcija topline, nesvjesnost nadolazeće opasnosti, nesvjestica.

Saunu ne smiju koristiti:

- djeca mlađa od 6 godina.
- osobe s teškim reakcijama na sunčevu svjetlost.
- starije osobe ili osobe s invaliditetom.
- osobe s već postojećim stanjima kao što su bolesti srca, visoki ili niski krvni tlak, problemi s cirkulacijom krvi ili dijabetes, bez prethodnog liječničkog savjeta.
- trudne žene, previsoka temperatura može ugroziti plod.
- osobe s dehidracijom, otvorenim ranama, očnim bolestima, opeklinama ili sunčanim udarom.

Djeca od 6 do 16 godina mogu koristiti saunu ako su stalno pod nadzorom odgovorne odrasle osobe i ako temperatura u sauni ne prelazi 60 °C.

Ako imate zdravstvenih problema, uzimate lijekove ili imate oštećene mišiće ili ligamente, saunu možete koristiti samo uz prethodnu konzultaciju i odobrenje liječnika.

Ako nosite kirurške implantate, nemojte koristiti saunu bez prethodnog savjetovanja i pristanka svog liječnika. Nemojte koristiti saunu nakon naporne aktivnosti.

Pričekajte 30 minuta da vam se tijelo ohladi.

Ne provodite više od 40 minuta u sauni odjednom

Ne konzumirajte alkohol ili droge prije ili tijekom saune.

Nemojte spavati u sauni koja radi.

Kako biste izbjegli rizik od pregrijavanja, spojite saunu na dovoljno jaku utičnicu i nemojte spajati druge električne uređaje na istu utičnicu.

Kako biste izbjegli opasnost od strujnog udara ili oštećenja saune, nemojte je koristiti:

- za vrijeme oluje.
- ako je električni kabel oštećen, mora ga zamijeniti kvalificirana osoba.
- ako se električni kabel pregrije, mora ga provjeriti kvalificirana osoba.
- ako trebate promijeniti žarulju, pričekajte da se sauna isključi i ohladi.
- Osušite ruke prije spajanja ili isključivanja napajanja.

Nikada ne radite s mokrim rukama ili nogama.

Nemojte brzo uključivati ili isključivati sustav napajanja ili grijanja jer to može uzrokovati oštećenje električnog sustava.

Ne pokušavajte sami popraviti saunu bez pristanka prodavača ili proizvođača.

Neovlašteni pokušaji popravka poništiti će jamstvo proizvođača.

Ne koristite nikakva sredstva za čišćenje u sauni.

Nemojte slagati niti spremati nikakve predmete u ili na saunu.

Ne stavljajte zapaljive materijale ili kemijske tvari blizu saune.

Nemojte prekrivati grijaće elemente!





Nemojte dirati grijaće tijekom ili neposredno nakon uporabe jer postoji opasnost od opekline.



Kad se kabina ne koristi, isključite je.

Tehničke specifikacije:

model	F30310
materijal kabine	drvo smreke
dubina	2300mm
širina	3100mm
visina	2200mm
napetost	AC380V
peć za saunu	8KW

Montažni materijal (moguća odstupanja)

											
Ø3x16	Ø4x70	Ø4x60	Ø4x50	Ø4*40	Ø4*30	Ø4*18	Ø5*100	Ø6x60	Wood pad		
6x	103x	300x	76x	240x	62x	40x	2x	4x	2x	2x	4x

		
2x	10x	2x

Prije početka montaže uklonite transportnu ambalažu i provjerite je li vaša infracrvena kabina isporučena cjelovita i neoštećena.

Prije odabira prikladnog mjesta za saunu detaljno pročitajte upute za postavljanje. Sauna je namijenjena samo za vanjsku ugradnju.

Odaberite mjesto:

- Na suhom mjestu na ravnoj, stabilnoj površini koja može izdržati težinu vaše saune.
- Visina mora biti dovoljna za doseganje stropa i izvođenje električnih priključaka i radova održavanja.
- Ostavite dalje od izvora vode, vatre ili zapaljivih materijala.

Praktičan savjet

- imajte na umu da su za postavljanje saune potrebne najmanje 2 odrasle osobe.
- jasno identificirajte svaku ploču prije nego što počnete
- prilikom postavljanja postavite strujni kabel vaše saune tako da bude lako dostupan
- imajte na umu da postoje razlike između modela.

VAŽNO :





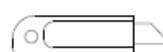
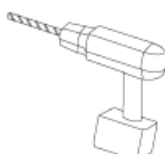
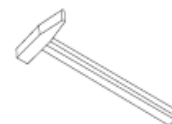
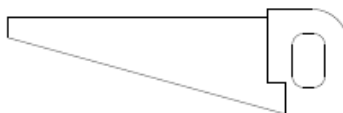
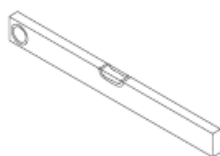



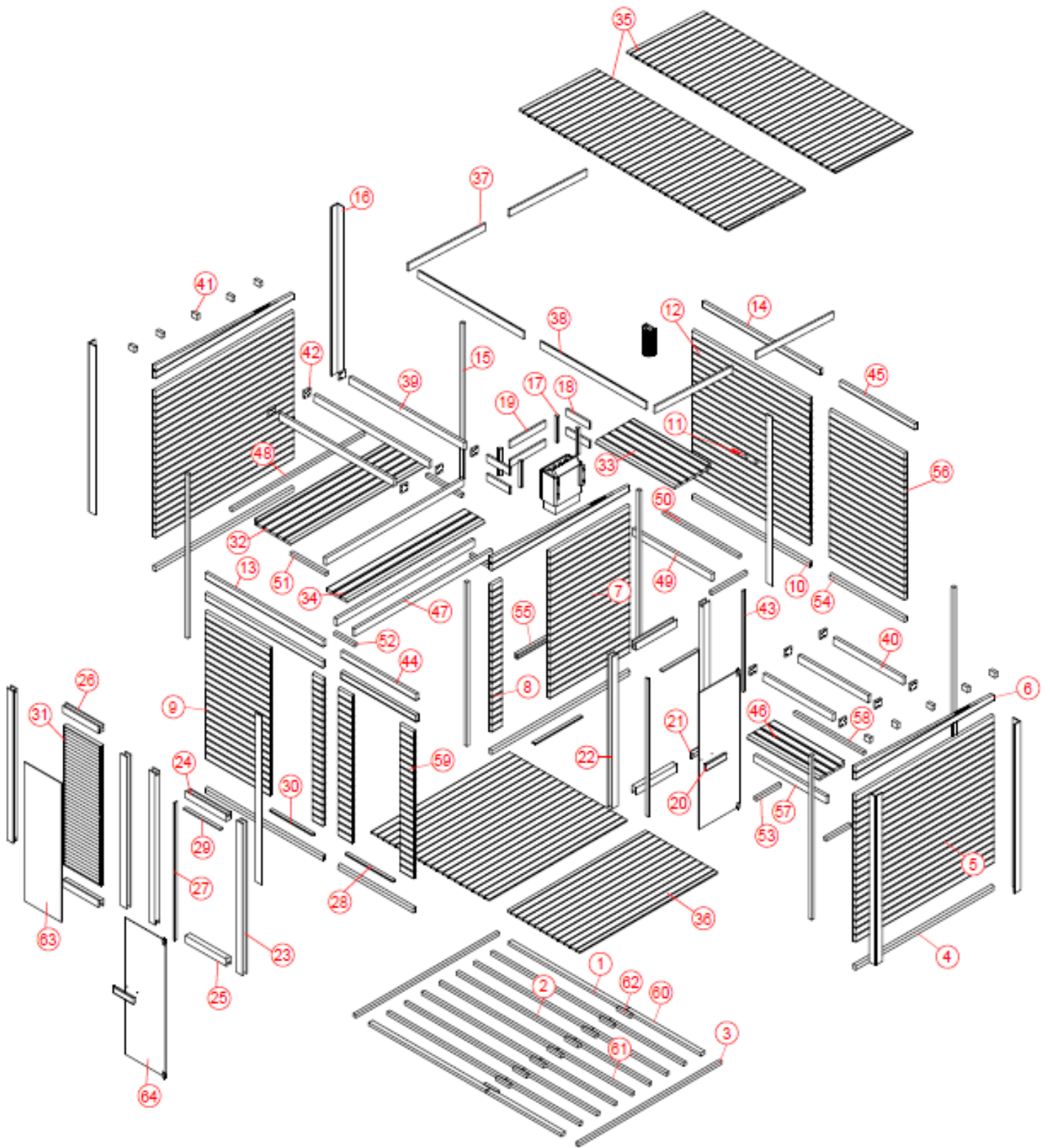

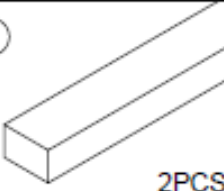
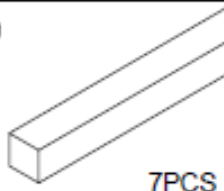
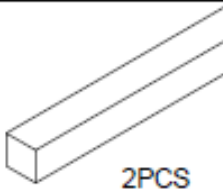
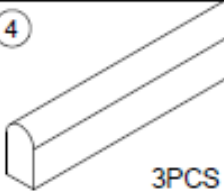
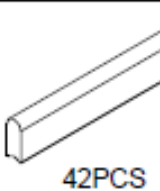

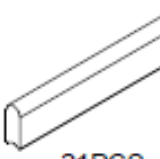

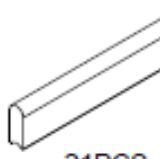
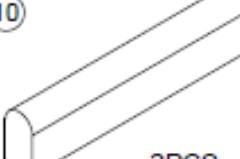
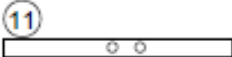
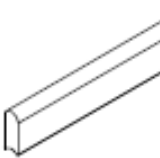



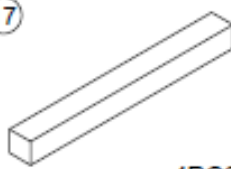

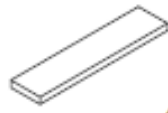
Provjerite upuštač i promjer rupa kako ne biste oštetili drvo.

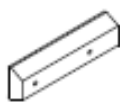
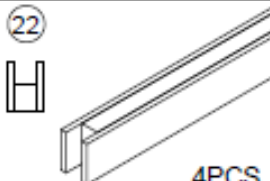
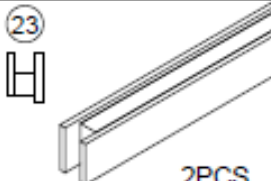
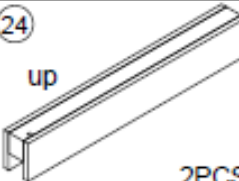
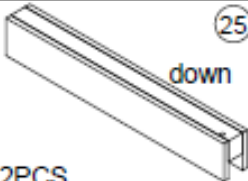
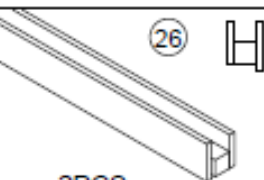
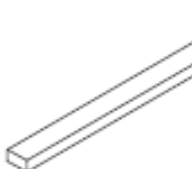
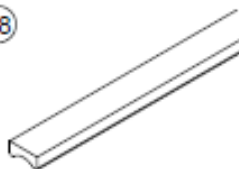

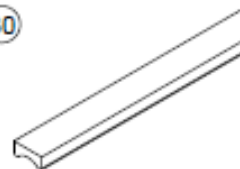

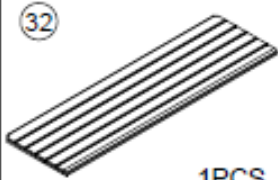
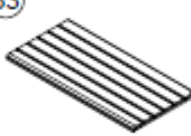

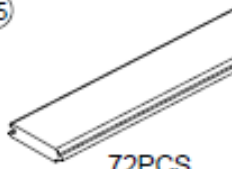
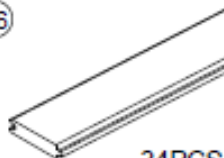

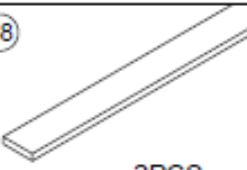
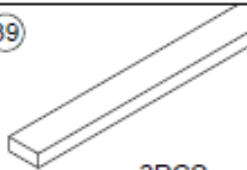
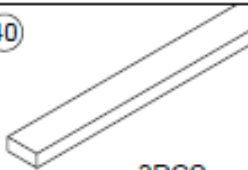



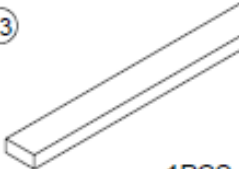

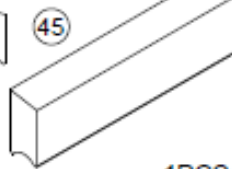
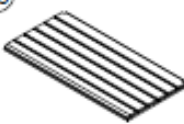
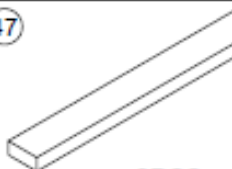

Alat:

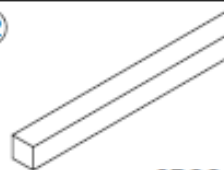
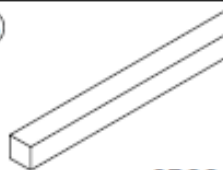

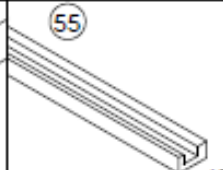
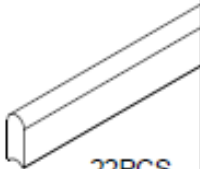
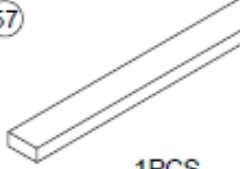
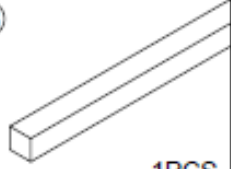
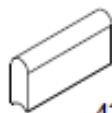
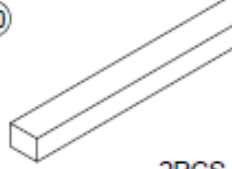
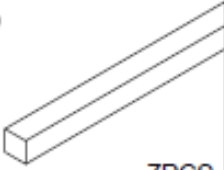
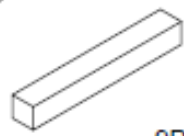
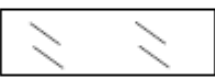
Popis dijelova:



①  2PCS 1724*55*38mm	②  7PCS 1724*38*38mm	③  2PCS 2100*38*38mm	④  3PCS 2024*67*38mm	⑤  42PCS 2024*97*38mm
⑥  3PCS 2024*168*38mm	⑦  21PCS 1172*97*38mm	⑧  42PCS 150*97*38mm	⑨  21PCS 945*97*38mm	⑩  2PCS 1724*67*38mm
⑪  1PCS 1724*97*38mm	⑫  21PCS 1724*97*38mm	⑬  1PCS 1724*81*38mm	⑭  1PCS 1724*70*38mm	⑮  6PCS 2188*38*38mm
⑯  10PCS 2140*90*13mm	⑰  4PCS 330*33*33mm	⑱  2PCS 520*90*20mm	⑲  4PCS 340*90*20mm	⑳  1PCS 300*90*40mm
㉑  1PCS 252*90*40mm	㉒  4PCS 1927*90*66mm	㉓  2PCS 1927*90*66mm	㉔  2PCS 600*90*66mm	㉕  2PCS 600*90*66mm
㉖  2PCS 547*90*66mm	㉗  2PCS 1747*40*13mm	㉘  2PCS 700*38*17mm	㉙  2PCS 537*40*13mm	㉚  1PCS 627*38*17mm
㉛  1PCS 1765*545*47mm	㉜  1PCS 2022*560*33mm	㉝  1PCS 1162*560*33mm	㉞  1PCS 2022*300*33mm	㉟  72PCS 1130*97*18mm
㊱  34PCS 2022*97*18mm	㊲  4PCS 1132*90*20mm	㊳  2PCS 1552*90*20mm	㊴  3PCS 1684*90*38mm	㊵  3PCS 1022*90*38mm

 10PCS 80*60*38mm	 12PCS 90*90*20mm	 1PCS 1550*33*13mm	 1PCS 1100*81*38mm	 1PCS 1100*70*38mm
 1PCS 1060*400*33mm	 3PCS 2022*90*38mm	 1PCS 1946*38*38mm	 1PCS 1162*90*38mm	 1PCS 1124*38*38mm
 3PCS 522*38*38mm	 2PCS 300*38*38mm	 2PCS 362*38*38mm	 2PCS 1100*67*38mm	 1PCS 820*40*20mm
 22PCS 1100*97*38mm	 1PCS 1060*90*38mm	 1PCS 1022*38*38mm	 42PCS 198*97*38mm	 2PCS 1100*55*38mm
 7PCS 1100*38*38mm	 9PCS 200*38*38mm	 1PCS 1764*544*6mm	 1PCS 1733*594*6mm	 1PCS 300*142*105MM
 Sauna light	 Sauna stove	 69PCS 1000*320*5mm		

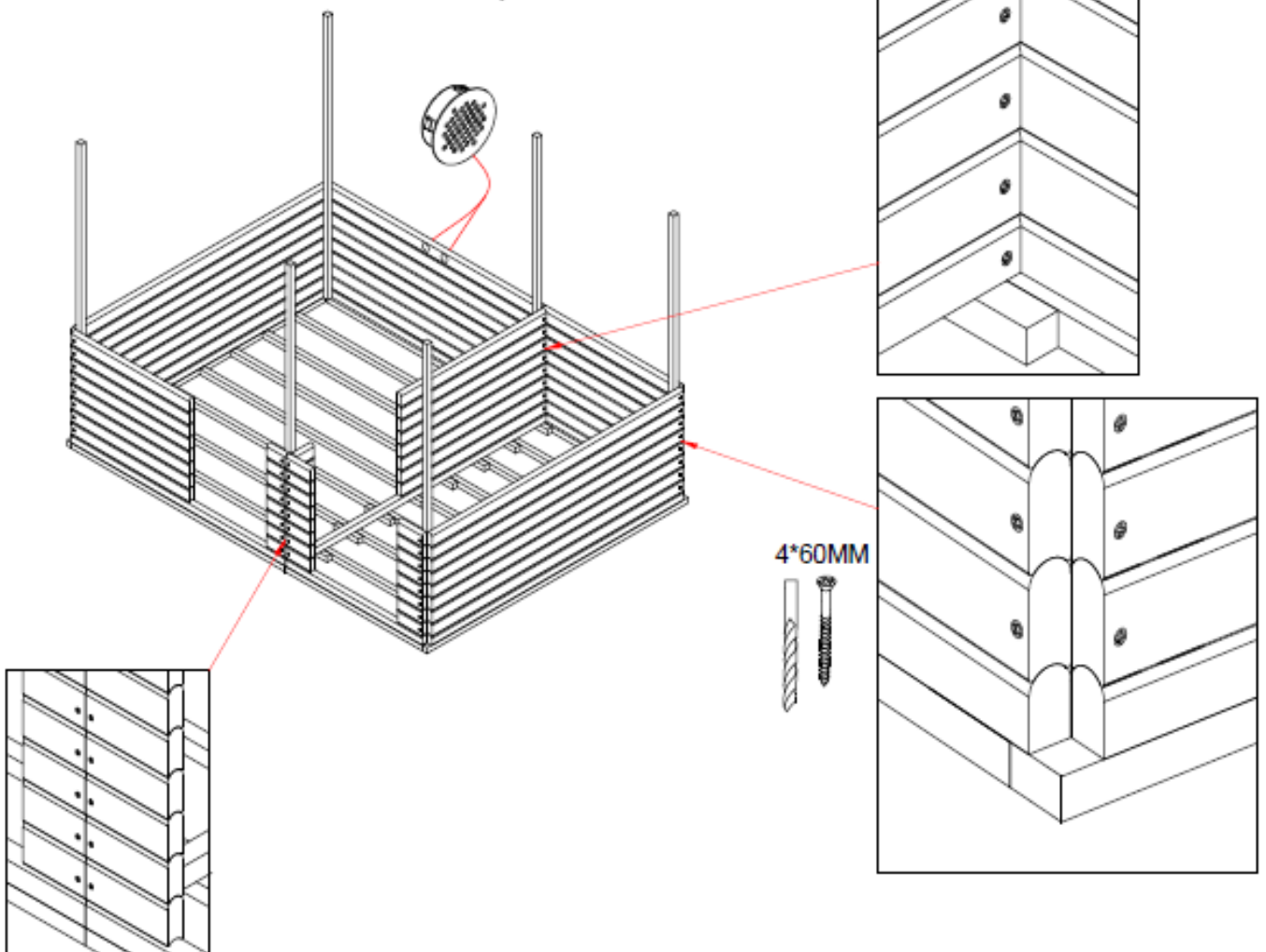
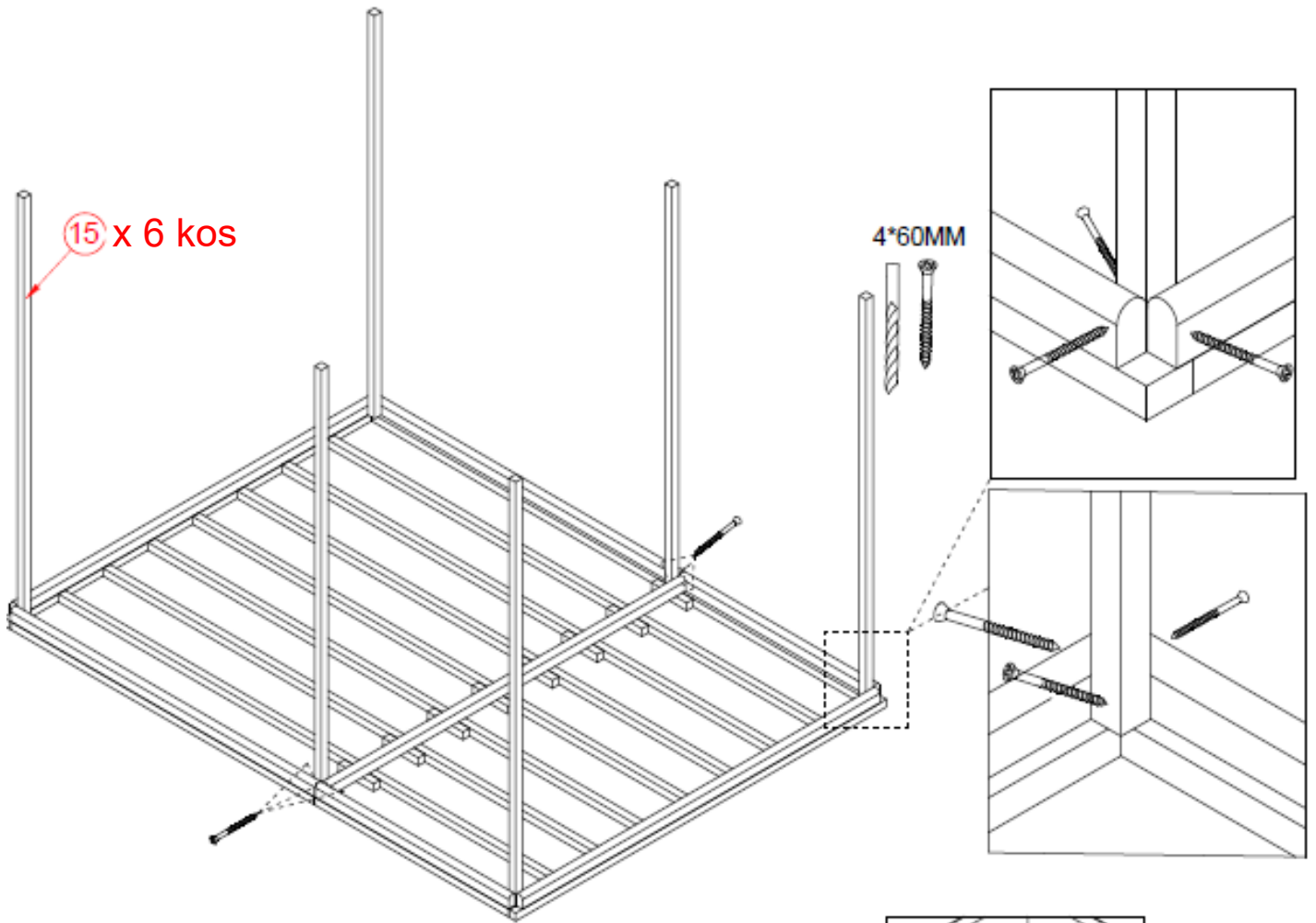

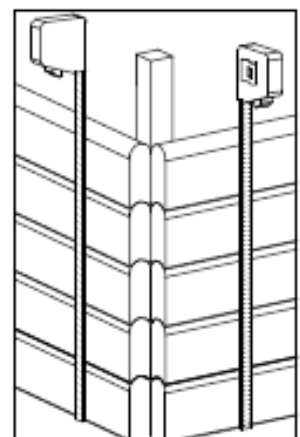
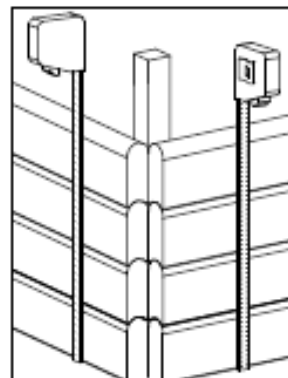
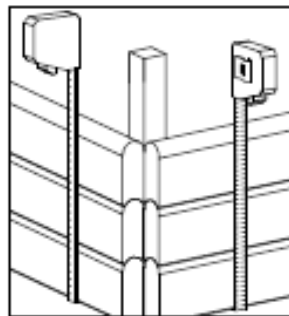
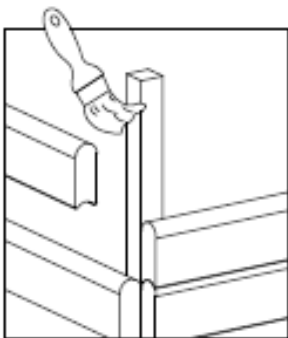
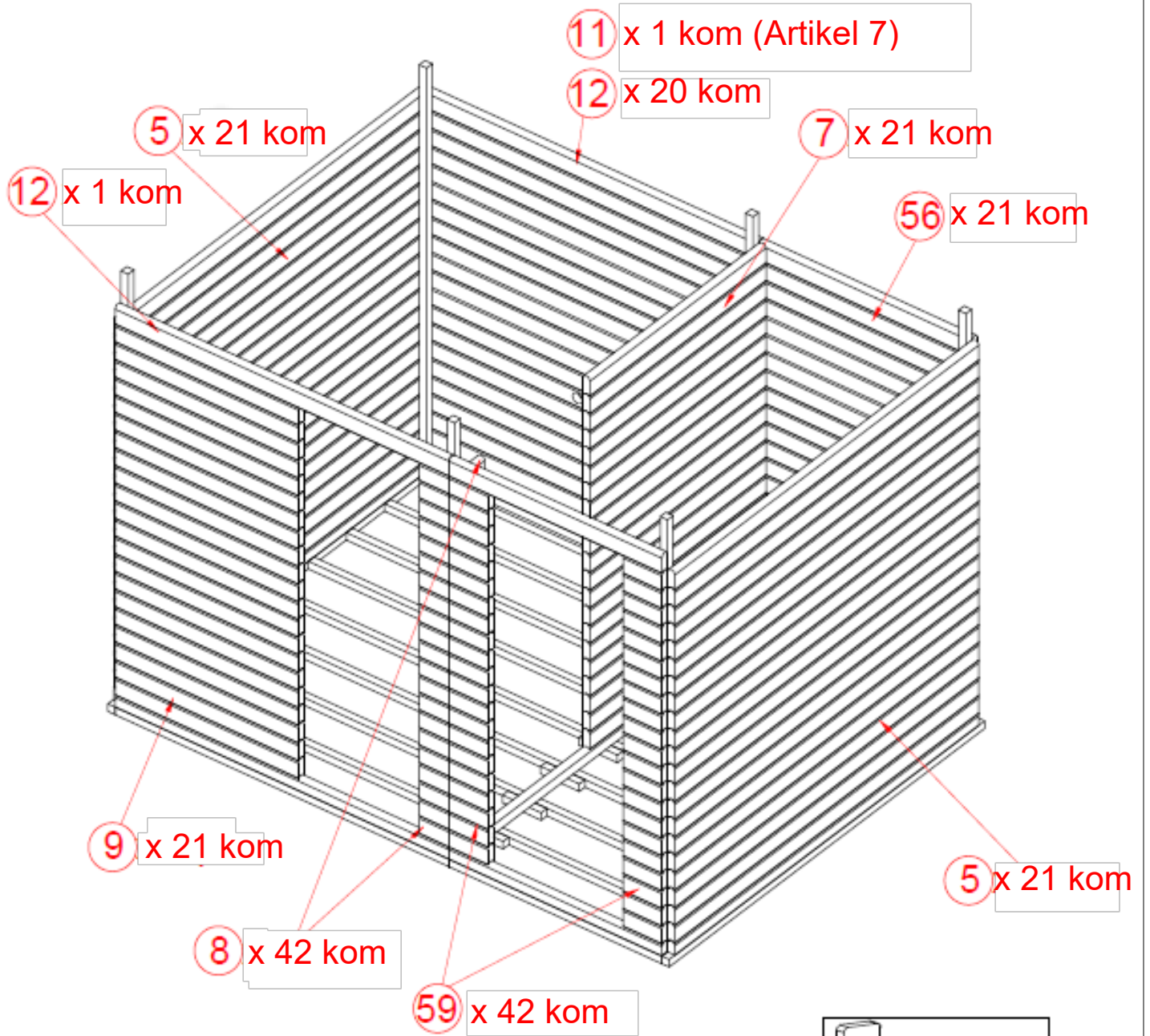

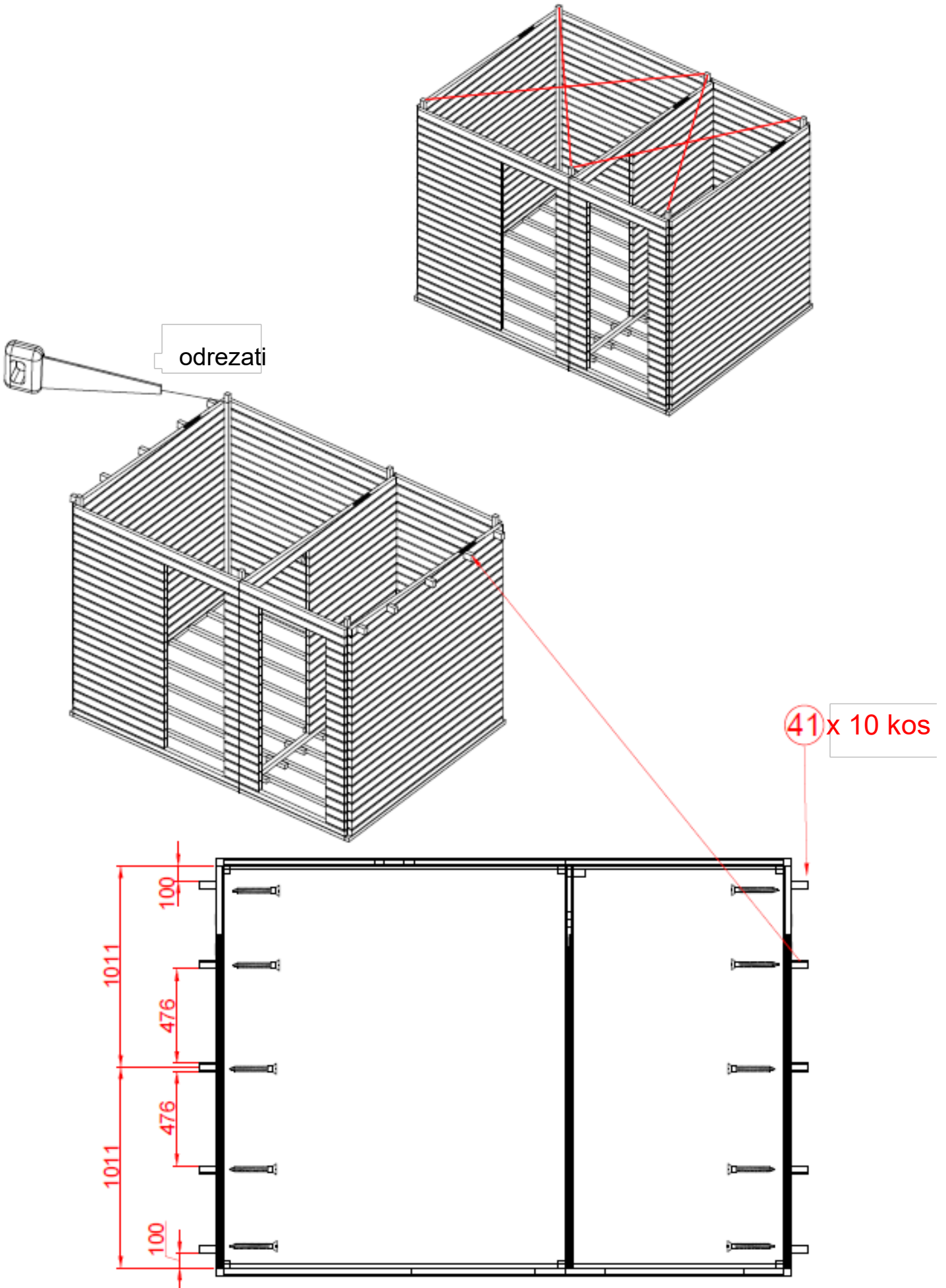

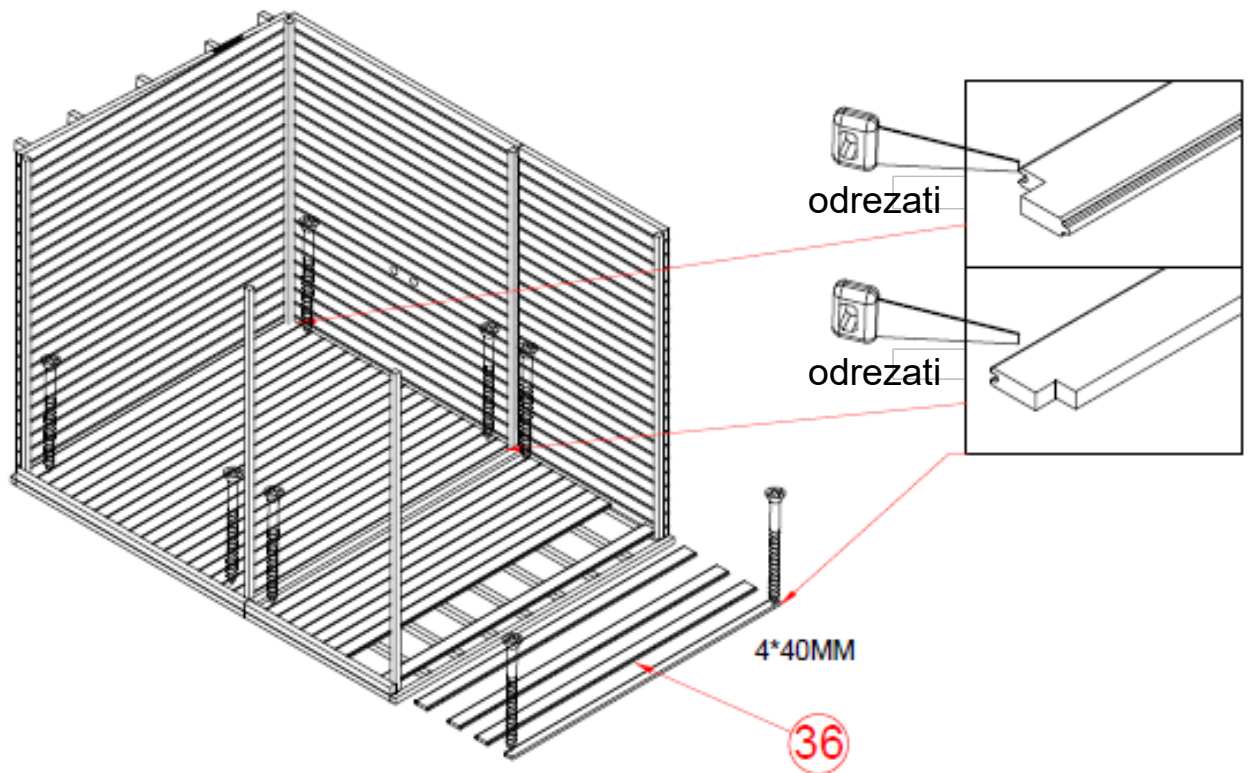
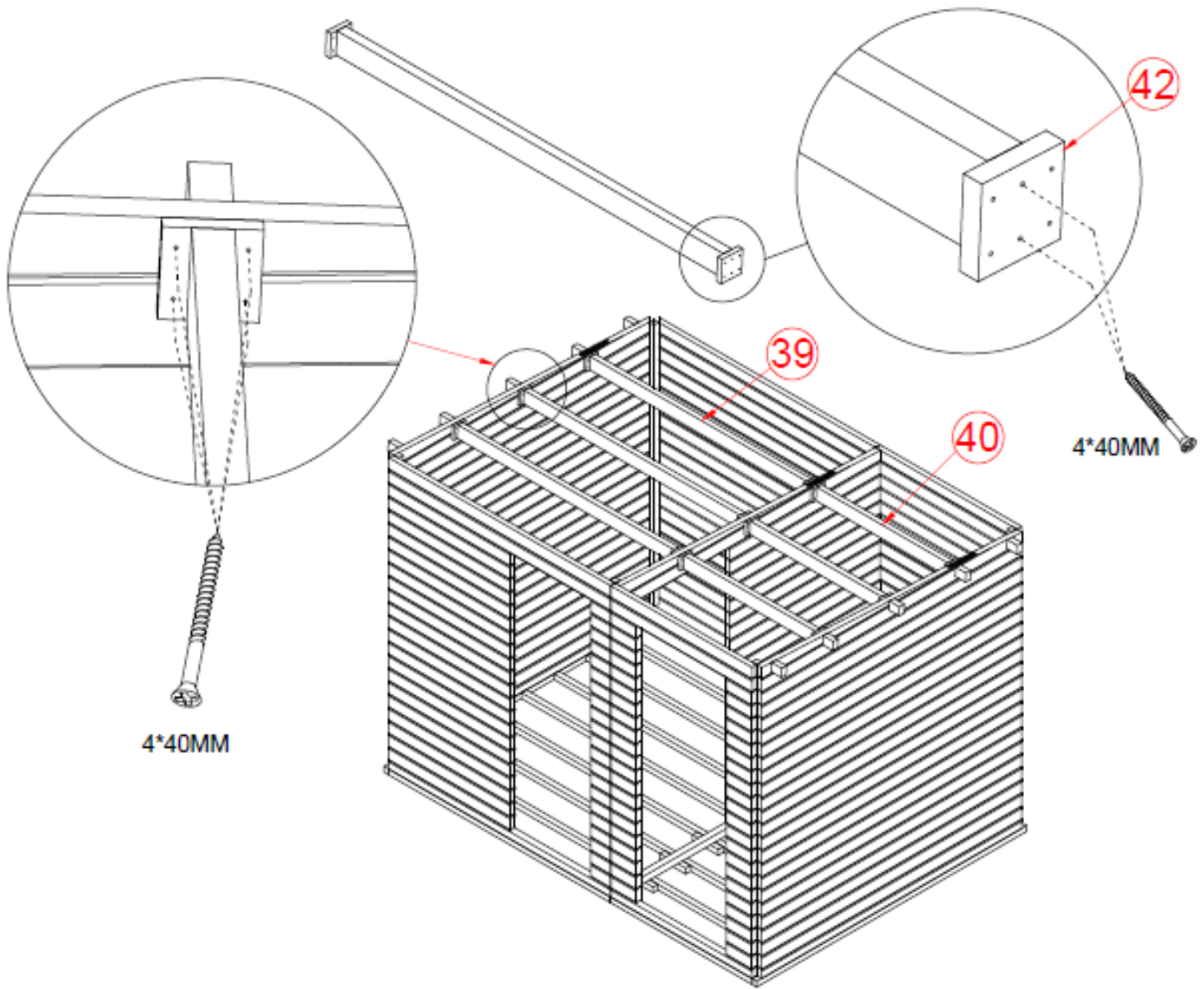

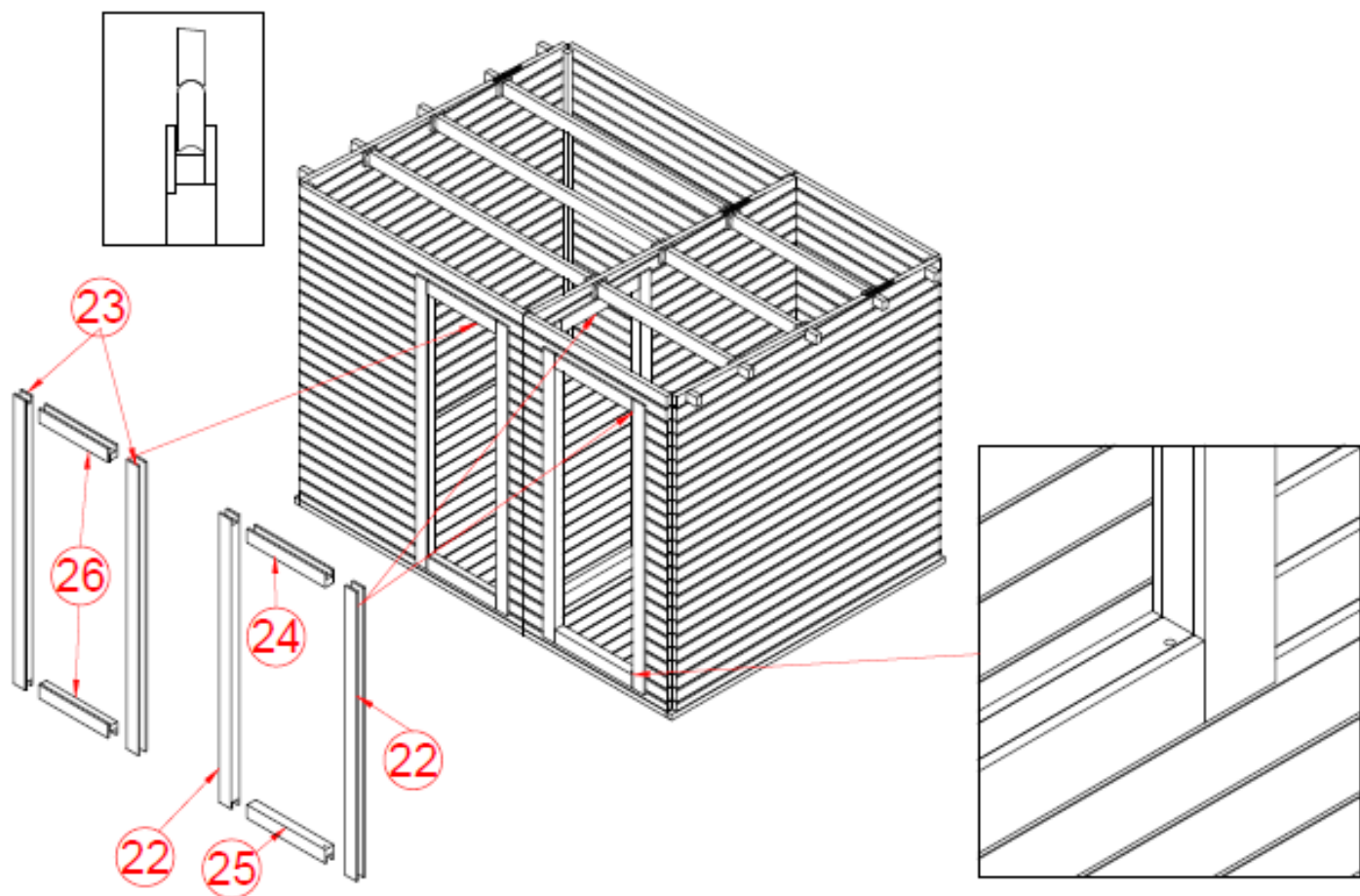
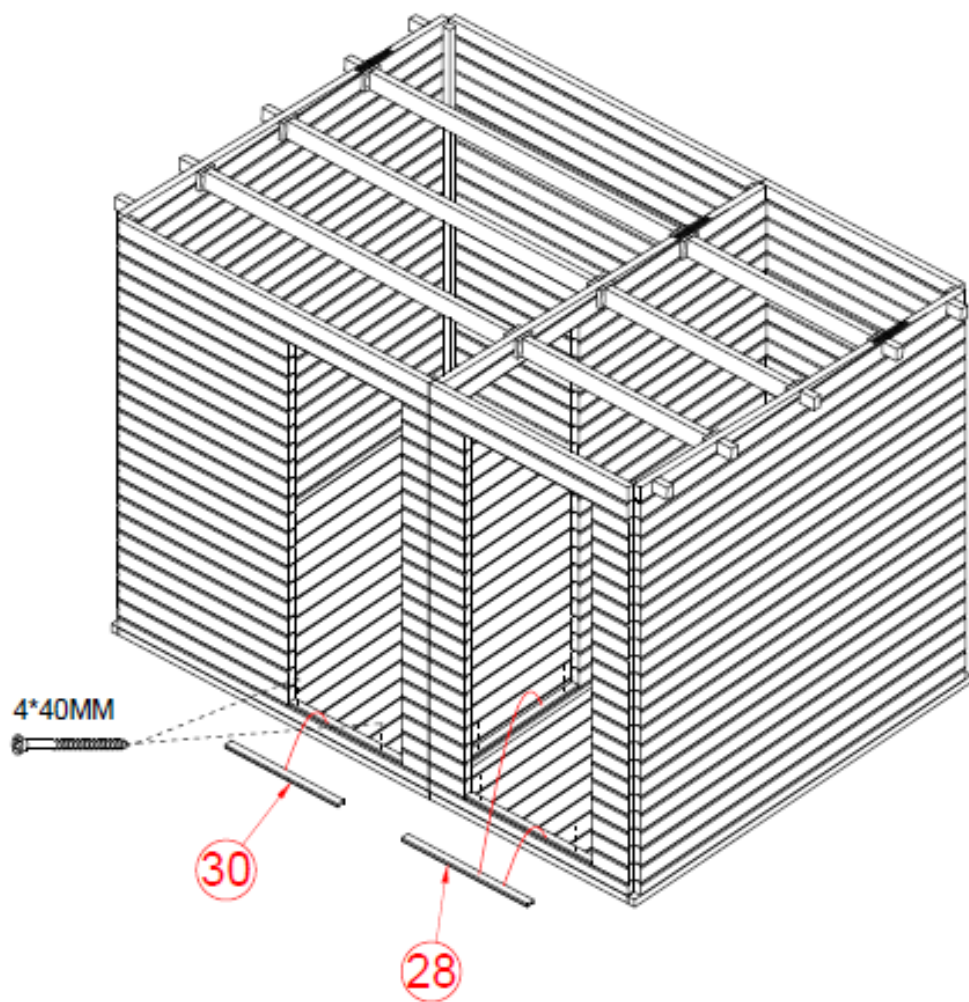

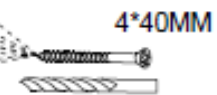
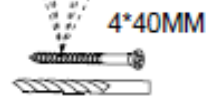
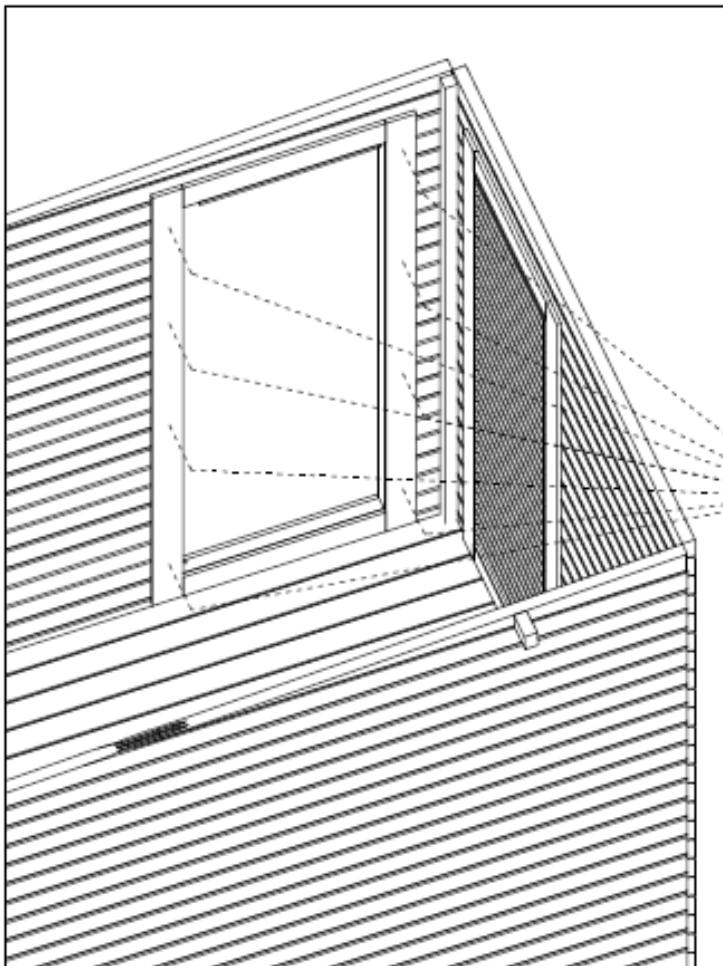
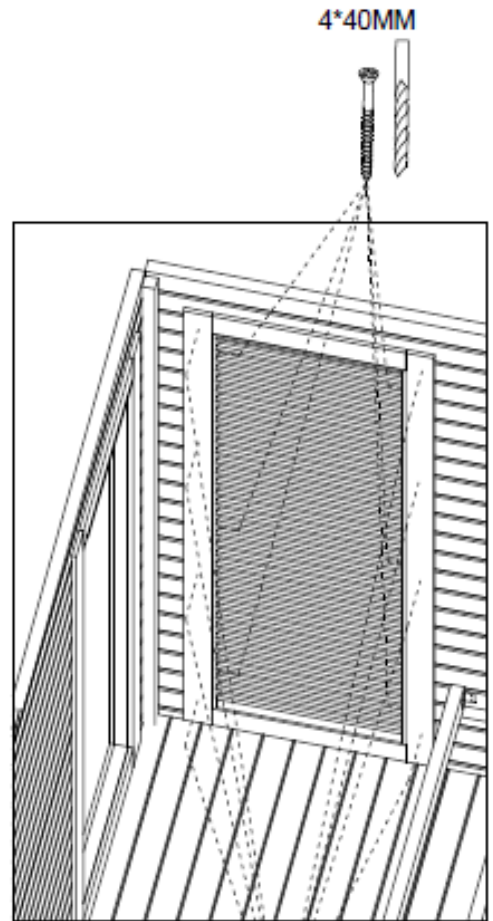
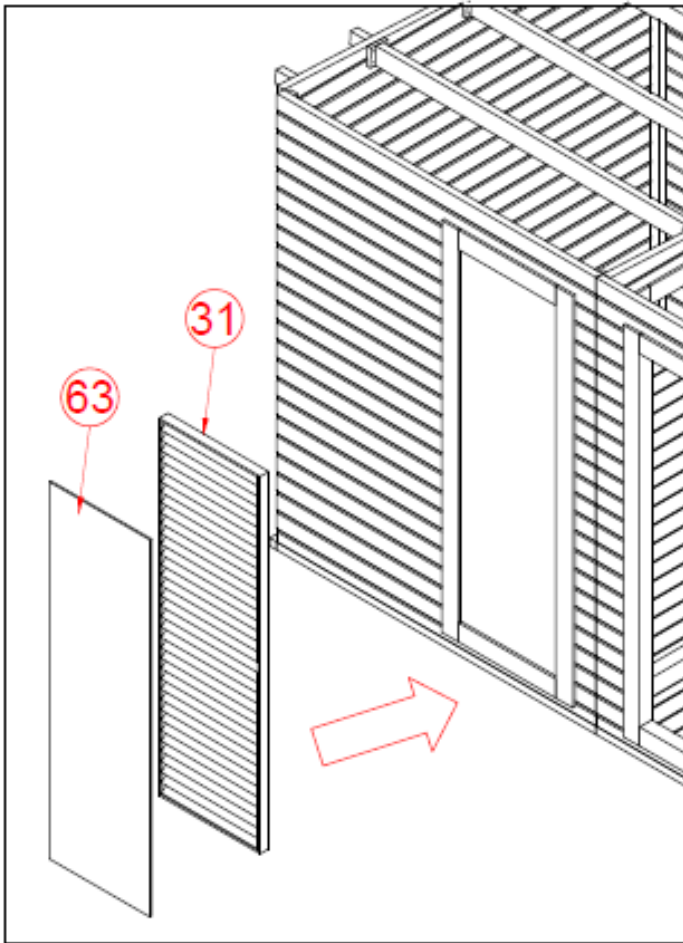

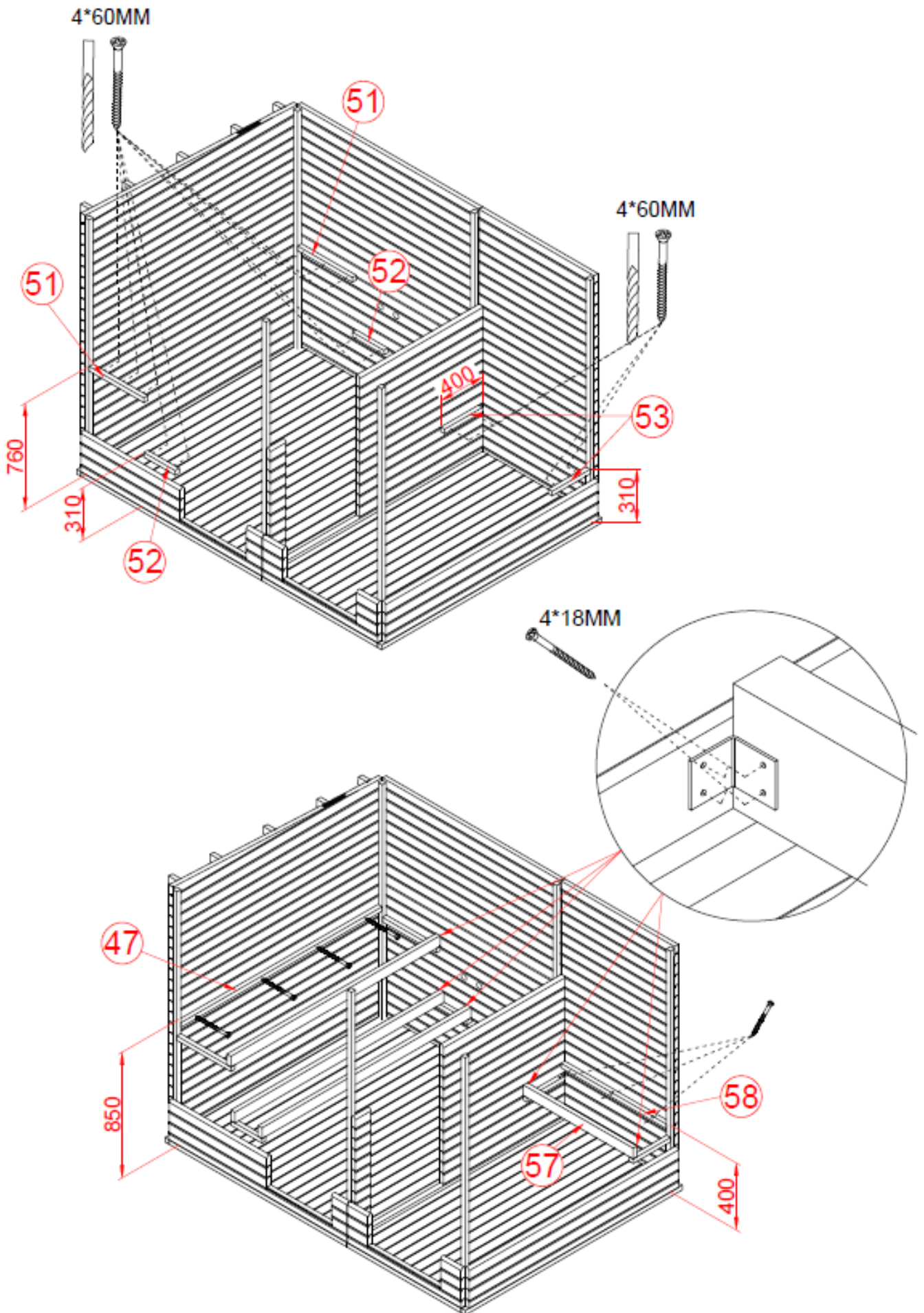

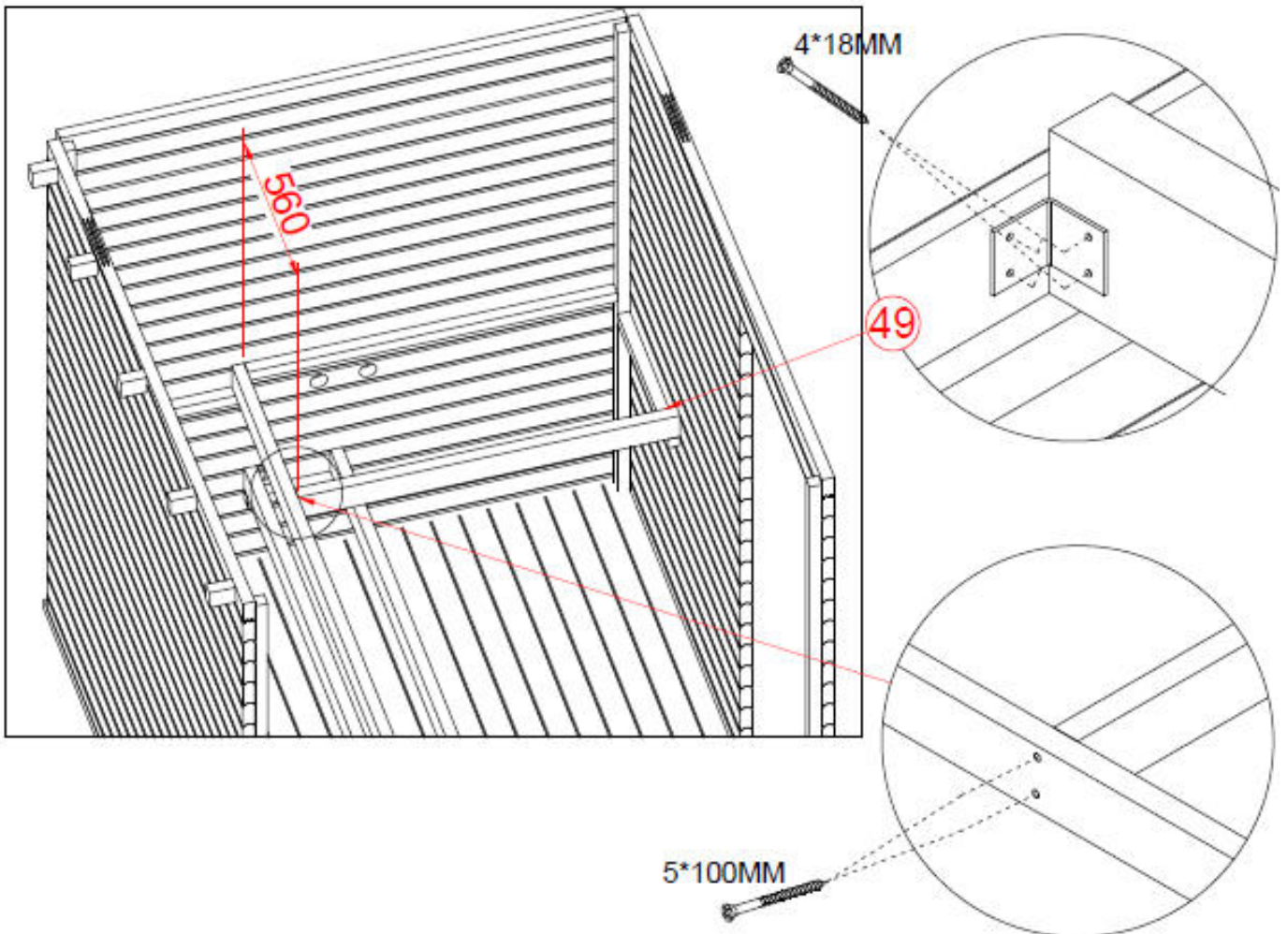
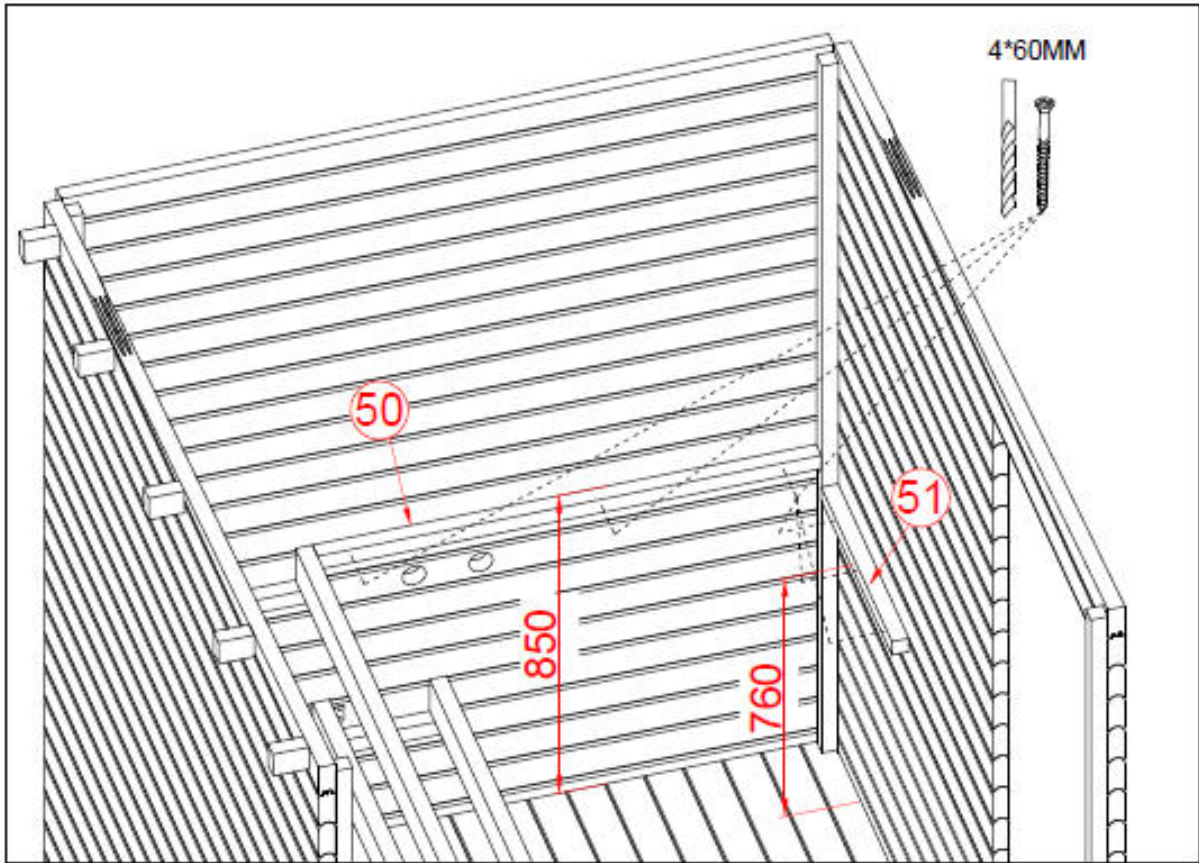

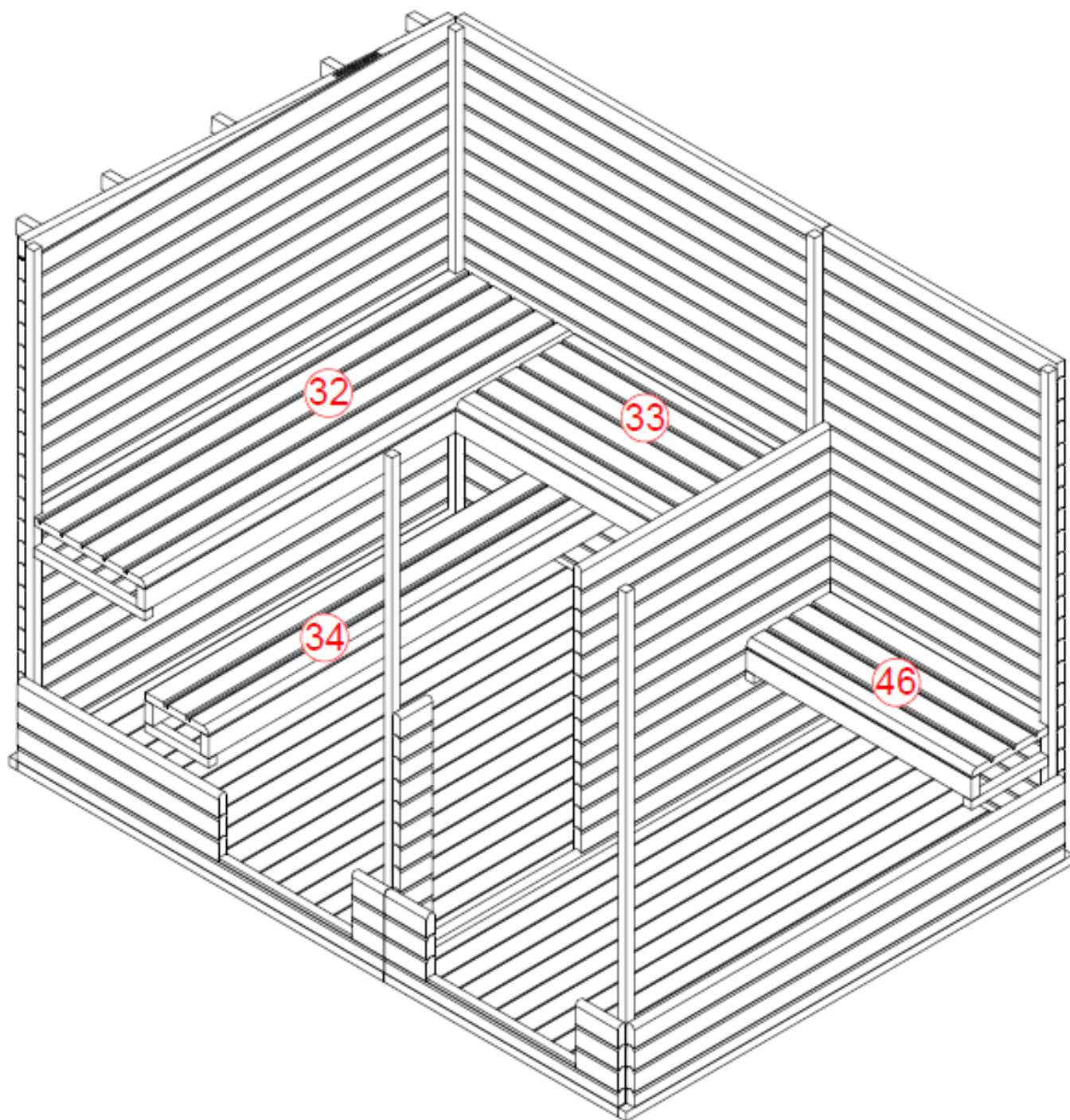

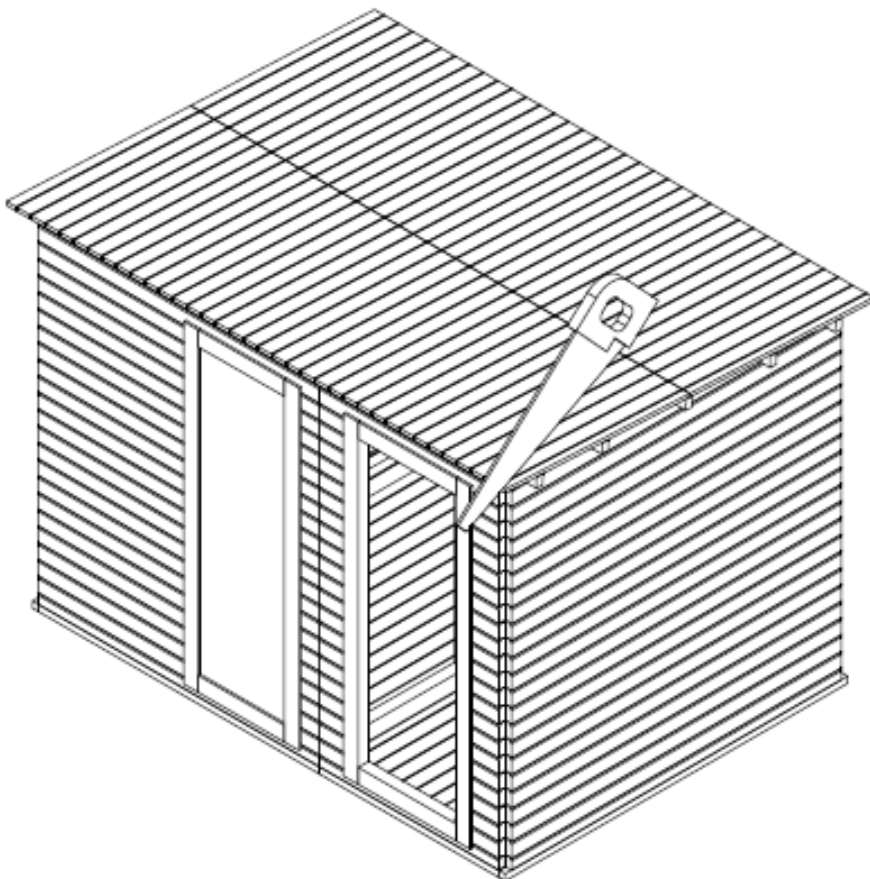
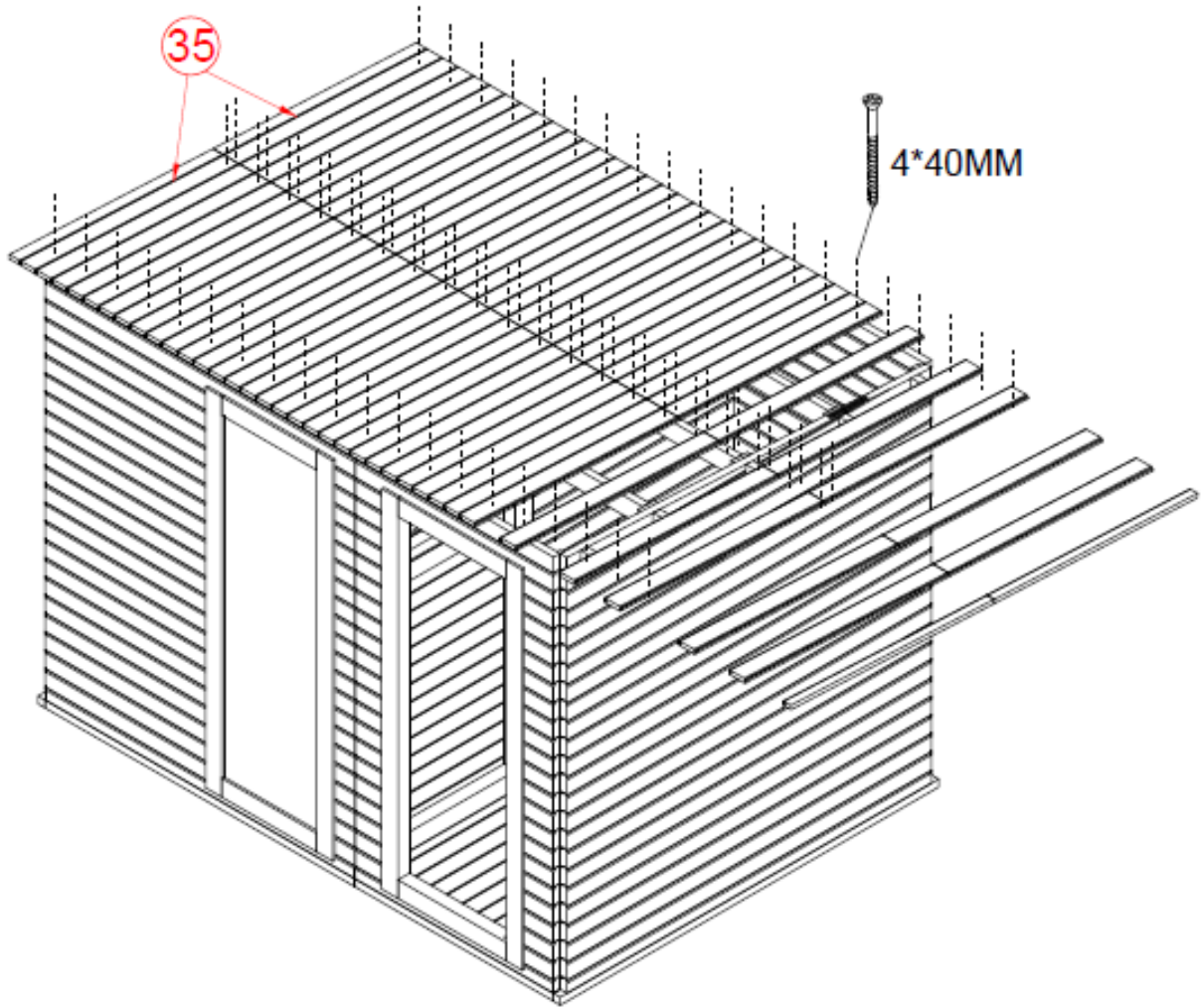

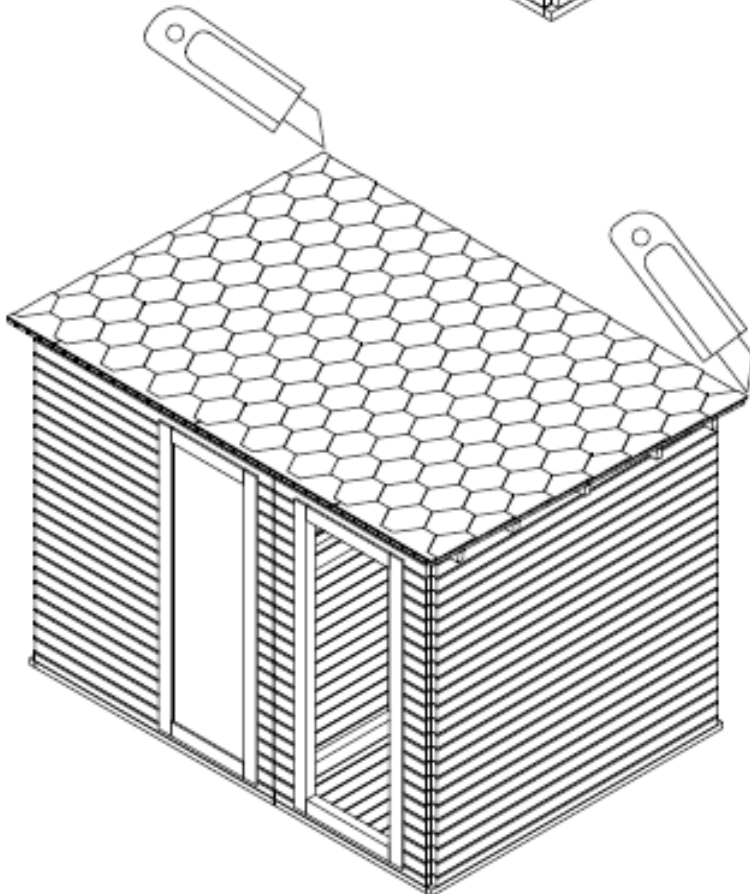
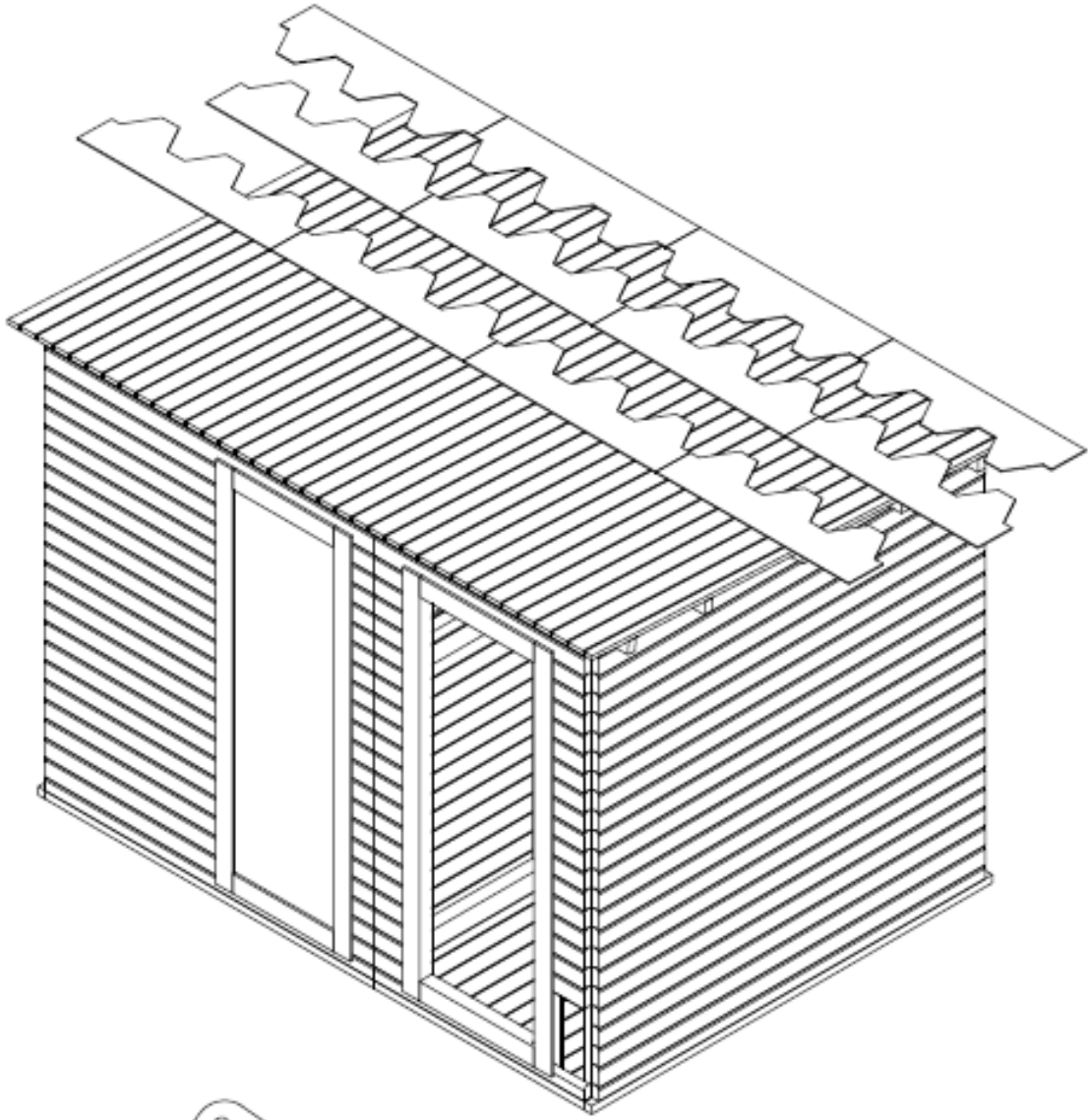

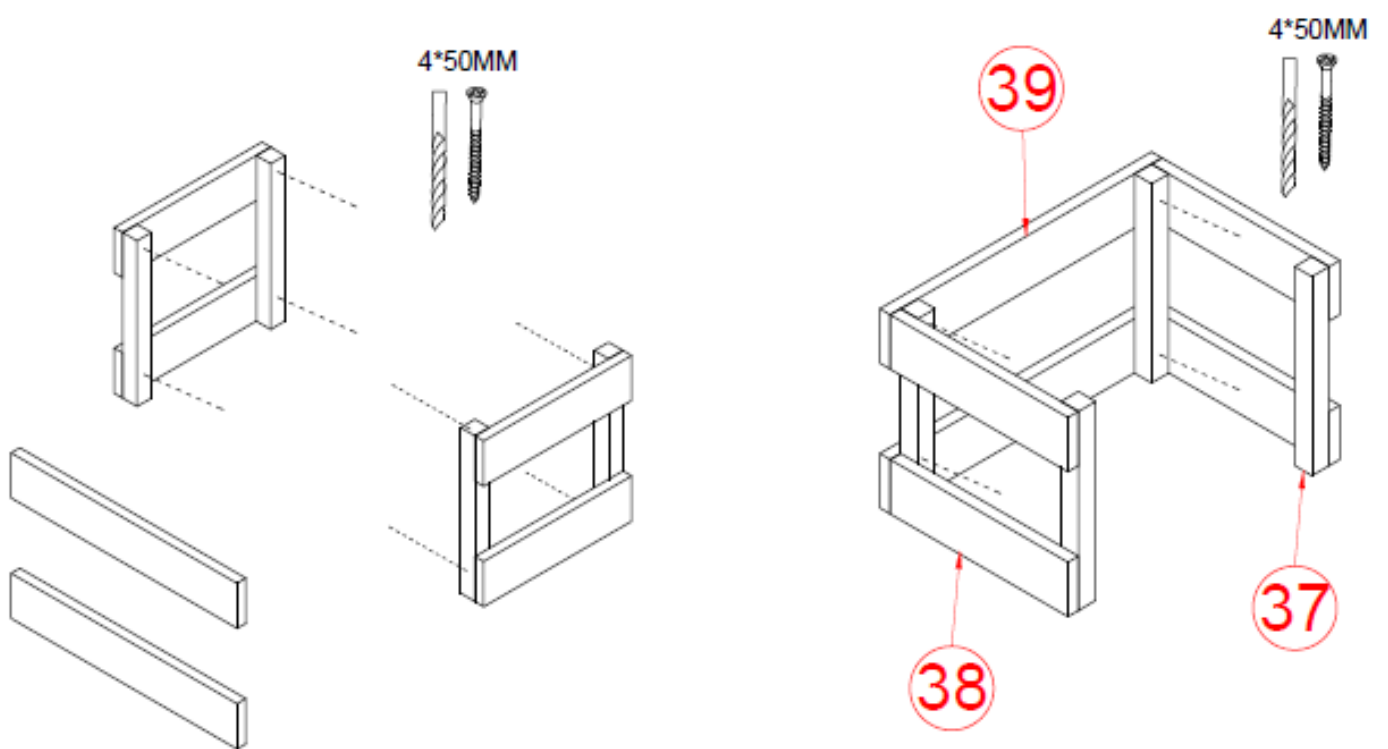
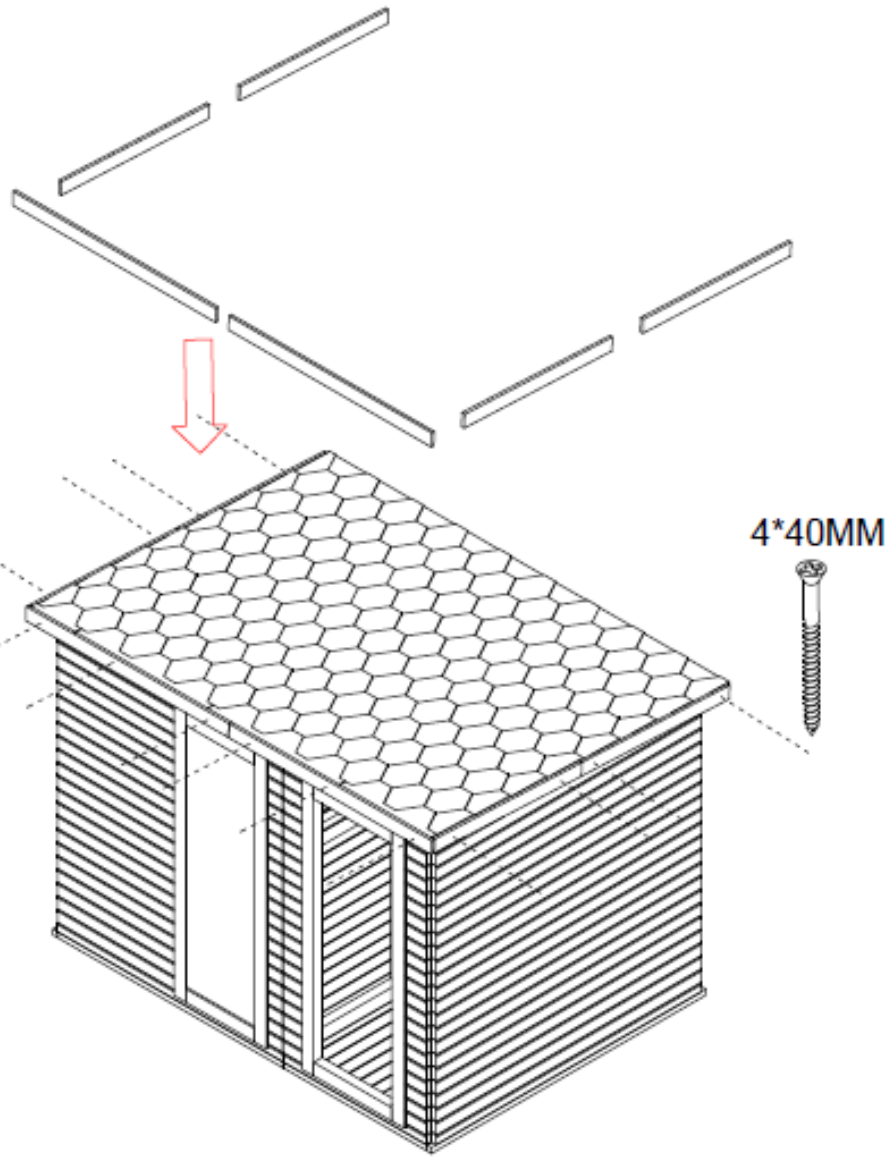

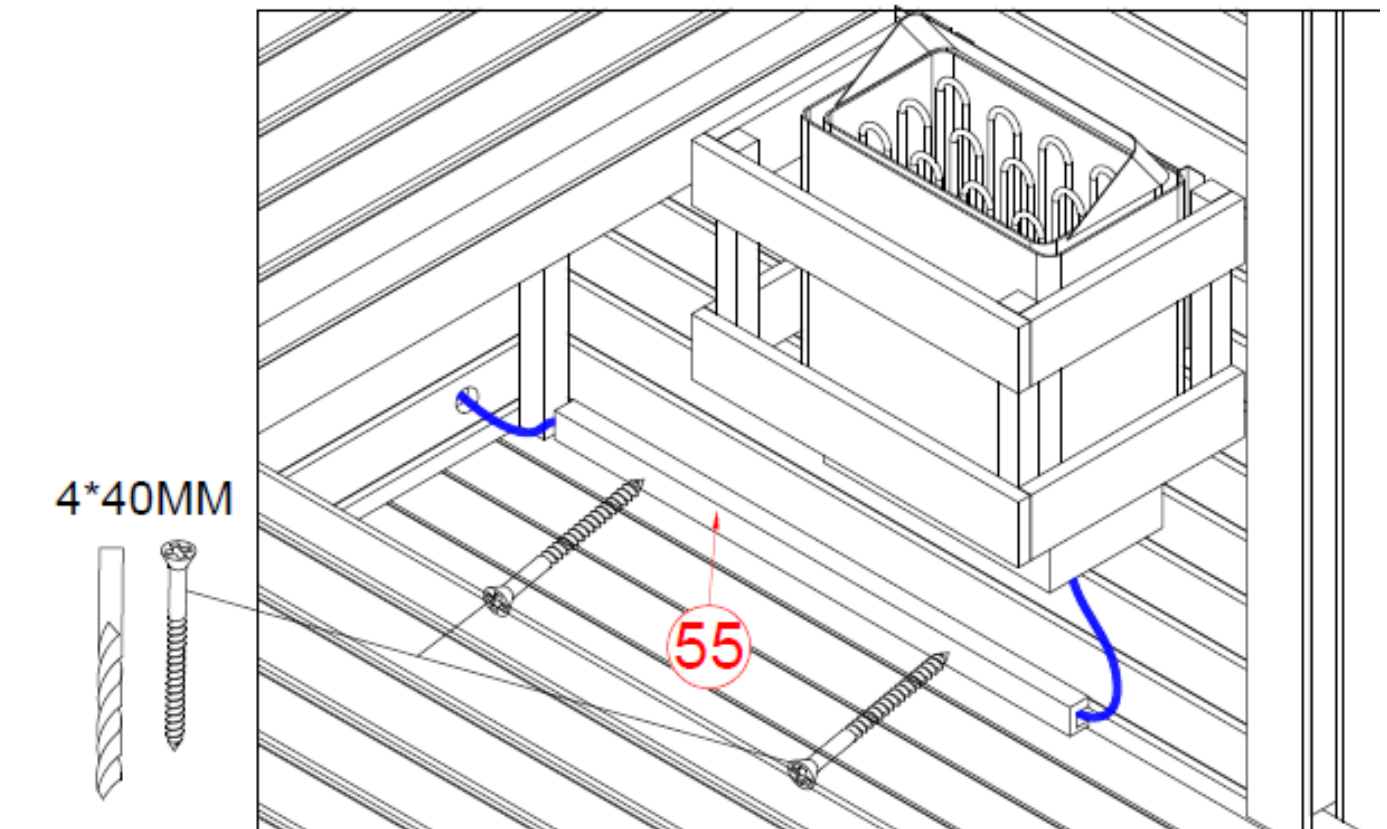
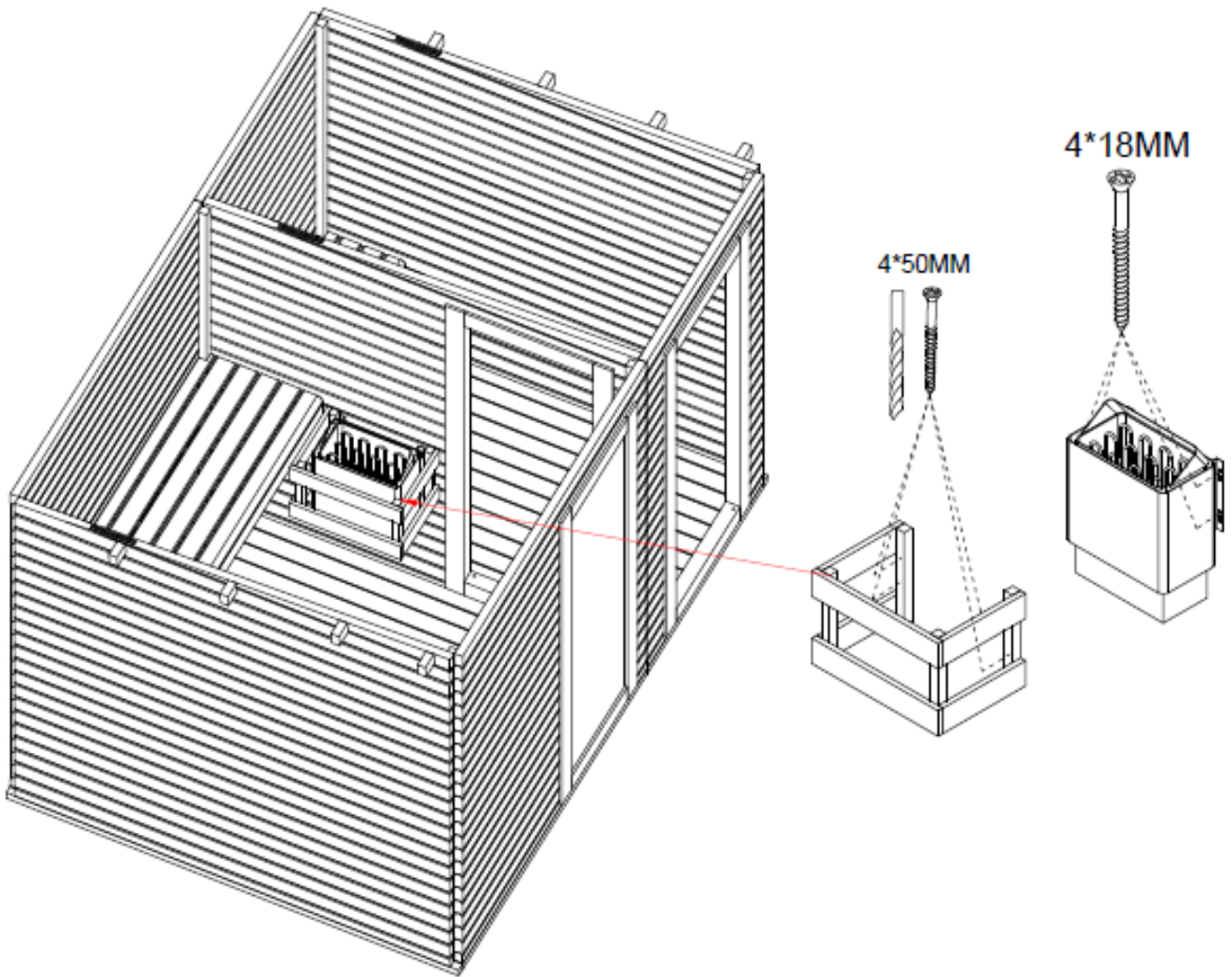

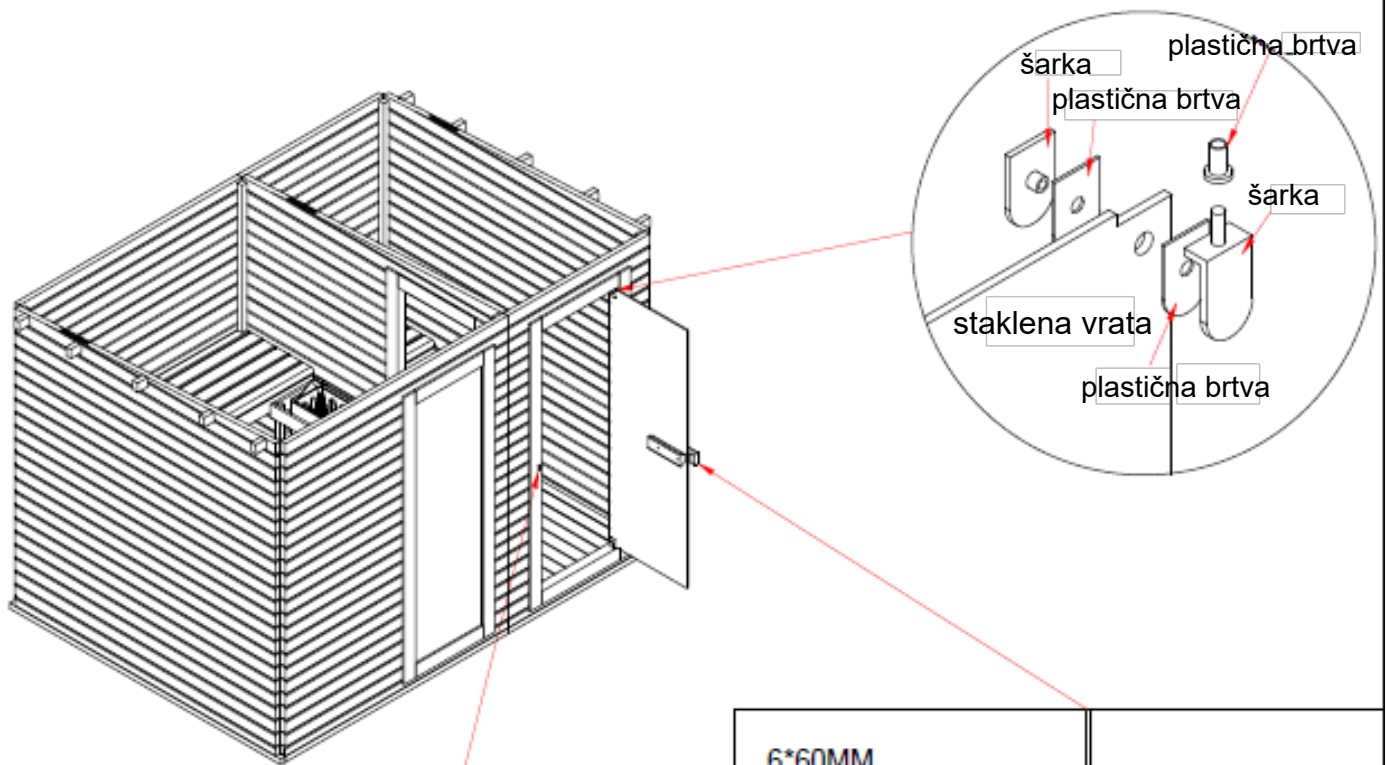
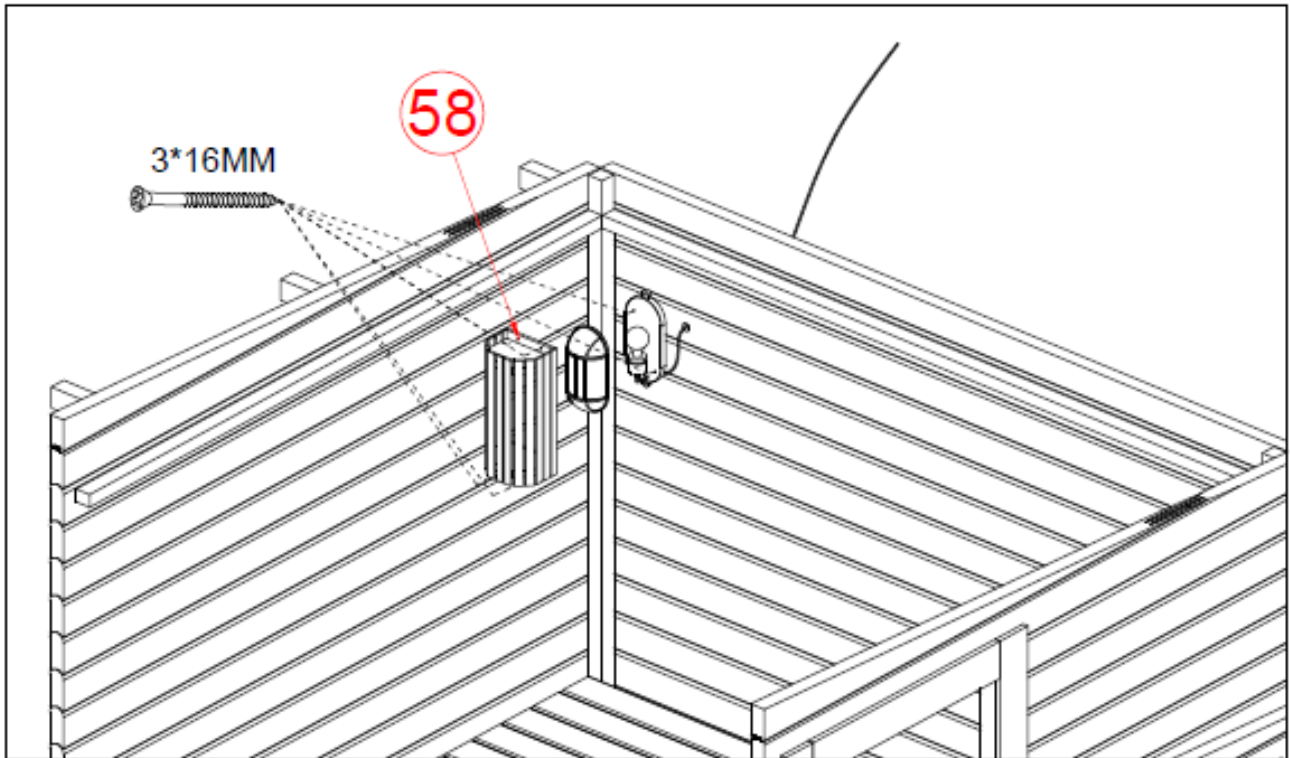

3*16MM

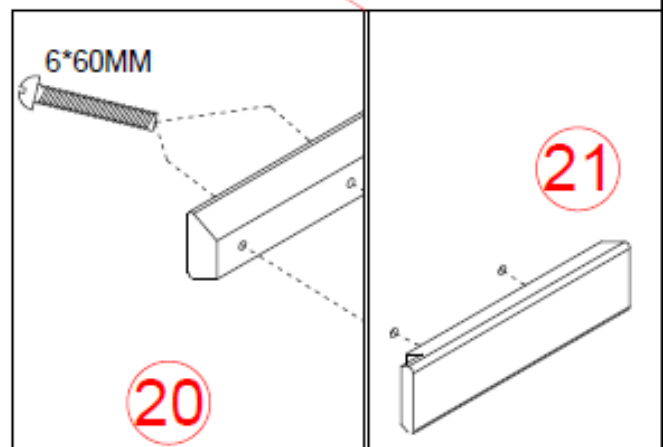

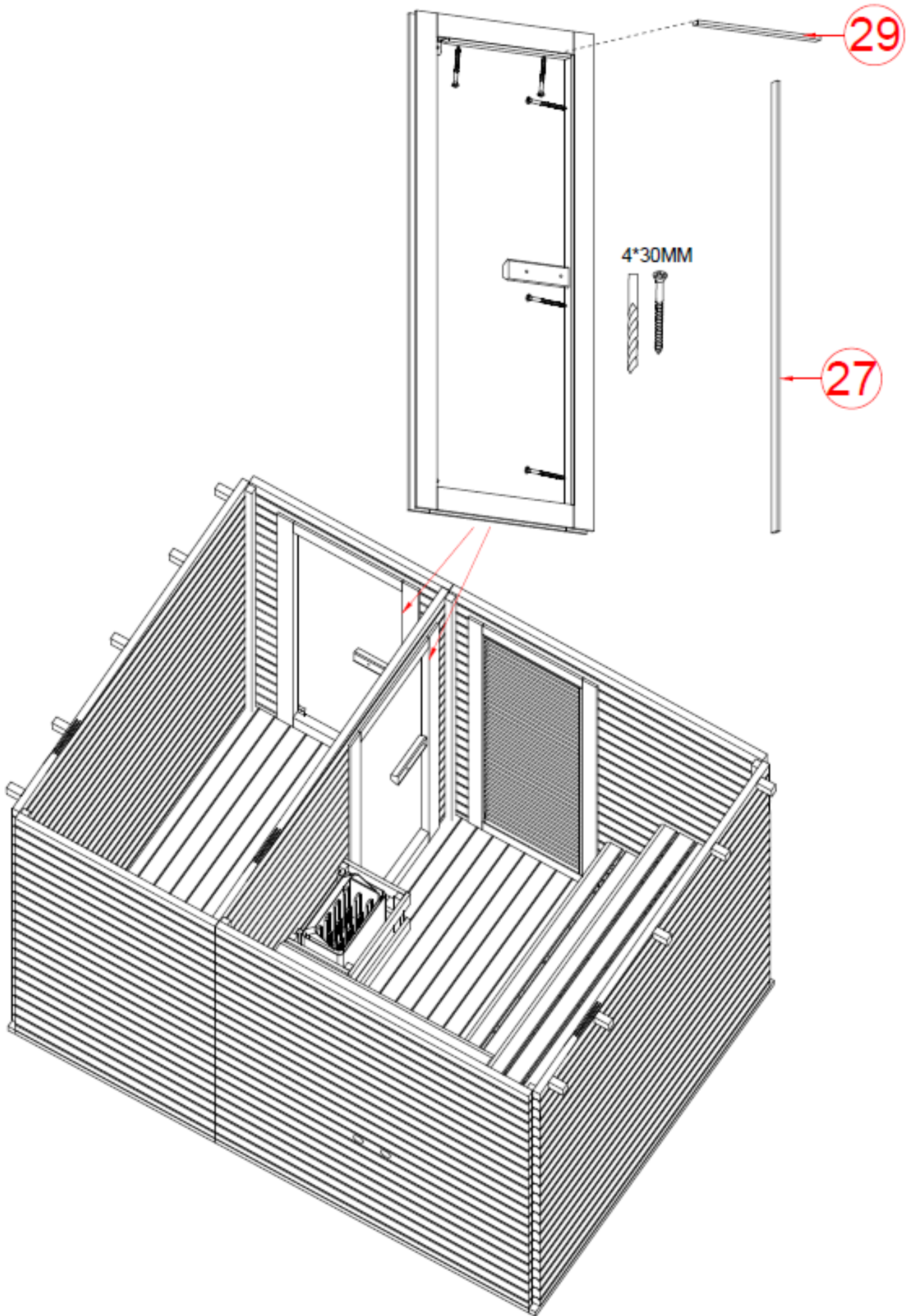

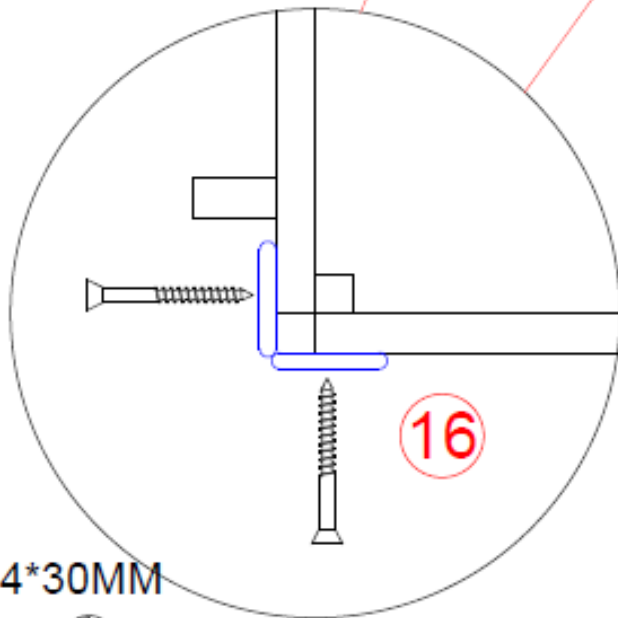
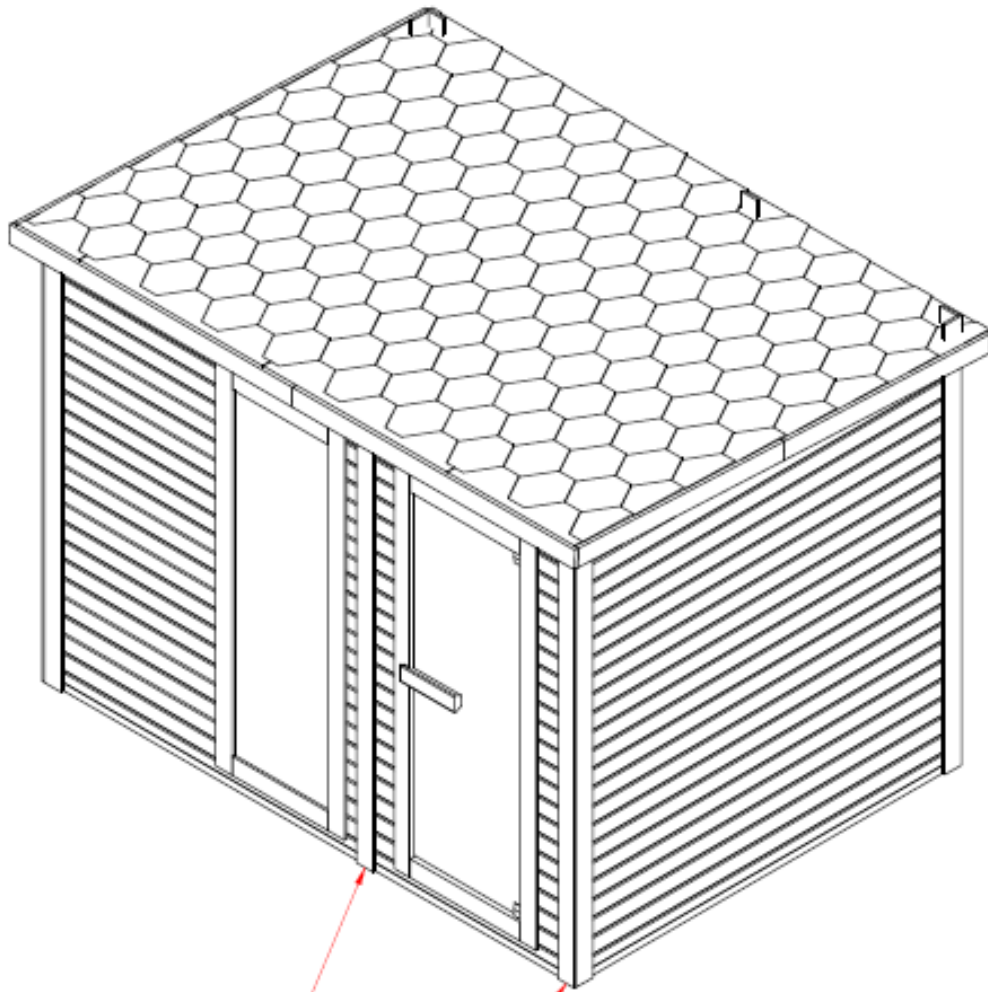

4*30MM

