

# Towel Rail Installation

This product needs to be fitted by a qualified person

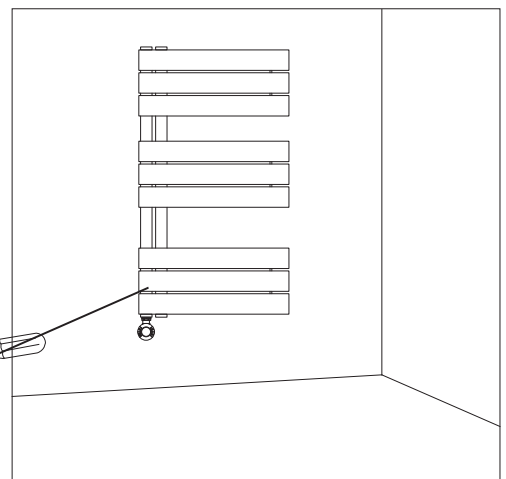

# AFD02-H Instruction

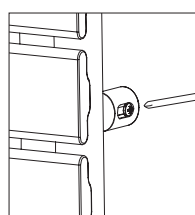
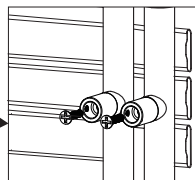
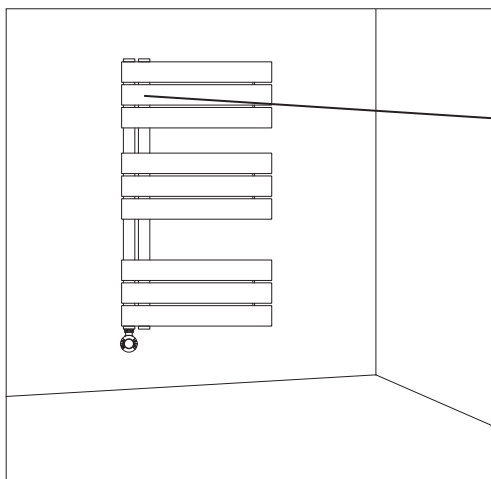
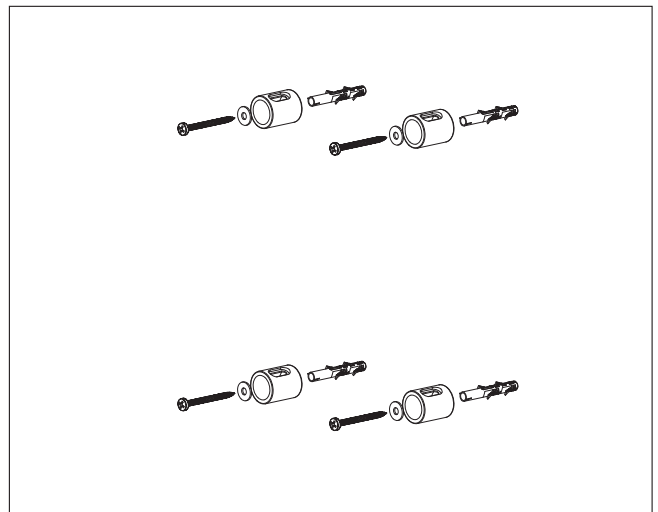
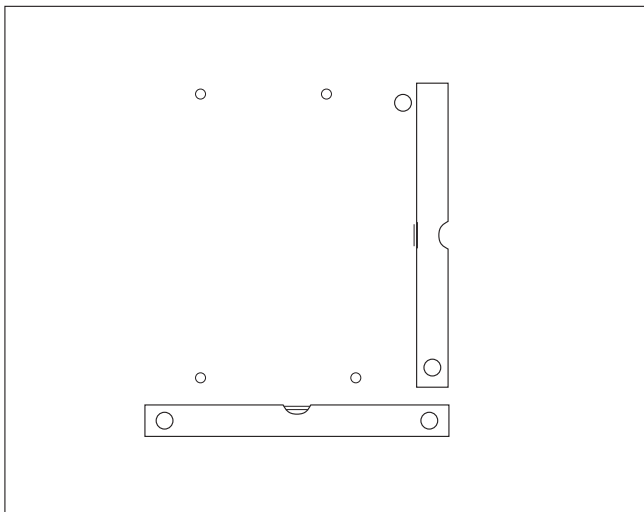
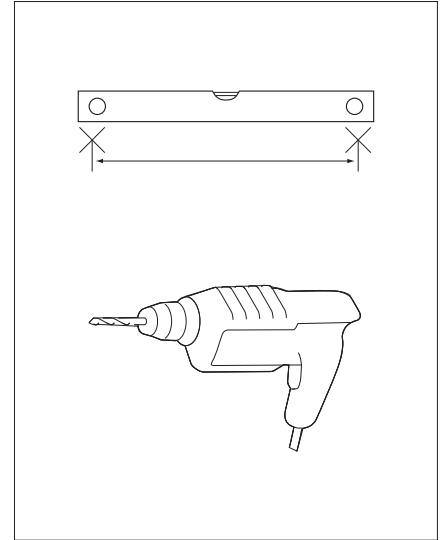
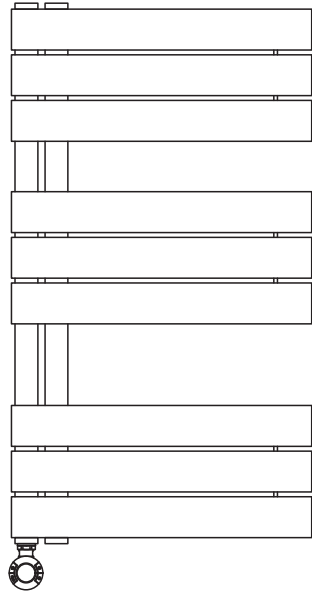





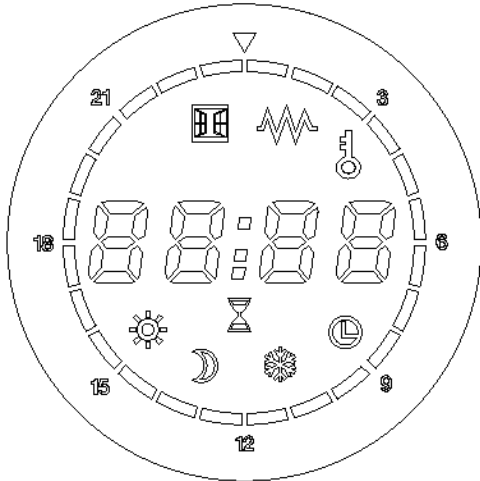



## 1.Basic Information:





- a)**Voltage:** 220-240V~/50-60HZ
- b)**Setting Temperature Range:** 7~30℃
- c)**Operating mode:** Comfort Mode/ECO Mode/ Week Timer Mode, Anti-Freeze Mode, Boost Mode

## 2.Screen display:



## 3.Symbol:

- 3.1 Symbol  **Comfort Mode:** heating temperature can be adjustable, range: 7℃~30℃
- 3.2 Symbol  **ECO Mode:** heating temperature can be adjustable , range: 7℃~30℃, it should be unable to set higher temperature than the one set in Comfort Mode
- 3.3 Symbol  **Anti-Freeze Mode:** heating temperature should be set and fixed at 7℃ by factory
- 3.4 Symbol  **Week Timer Mode:** can set One Day (24 Hours) desired heating time from Monday to Sunday
- 3.5 Symbol  **Boost Mode:** Boost mode with forcing timed heating function, and heating time can be freely adjusted.
- 3.6 Symbol  : display the set temperature or time
- 3.7 Symbol  **Window Open Mode:** Display when window open mode is activated
- 3.8 Symbol  : product in heating status
- 3.9 Symbol  **Key Lock:** unable to operate on any Key (except for On/Stand-By)
- 3.10 Symbol  **Time axis:** adjustable time range: 0~23H

- 3.11 Symbol  ON /Standby  Mode Switch
-  Plus  Minus





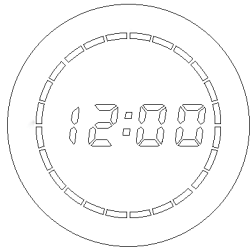

#### 4. Operate instruction

4.1 **Power ON:** After power on, the screen is fully displayed and then enters standby state display, as



shown : (In standby state, short press  the key to enter Operating mode, short press other keys will not respond to the product)

4.2 **Comfort Mode**  : as the image (4.2) the product default heating temperature should be set at 19°C, press

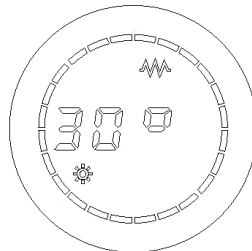

 or  shortly to set heating temperature, press  shortly to increase heating temperature, press  shortly to decrease heating temperature, 1°C per skip. Long press  or  can accelerate skip.



(4.2)

Under Comfort Mode to Press  shortly can switch into ECO Mode.

4.3 **ECO Mode**  : the product default heating temperature should be set at 15°C, press  or  shortly

to set temperature, press  shortly to increase heating temperature, press  shortly to decrease heating temperature, 1°C per skip. It should be unable to set higher heating temperature than the one set in Comfort

Model, as the image (4.3). Long press  or  can accelerate skip.

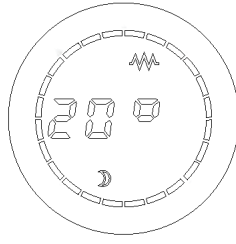

(4.3)

Under ECO Mode, press  shortly can switch into Anti-Freeze Mode.

**4.4 Anti-Freeze Mode**  : temperature should be set and fixed at 7°C by factory, as the image(4.4)

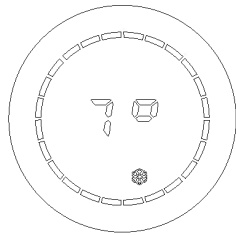

(4.4)

Under Anti-Freeze Mode, press  shortly can switch into Week Timer Mode.

**4.5 Week Timer Mode**  : For setting Time, Day and Week Timer.

Time and Day should be set firstly, when initial use or re start from power supply interruption, shows as the image (4.5).

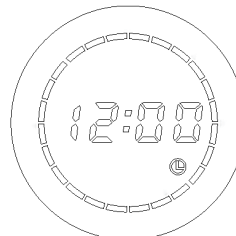



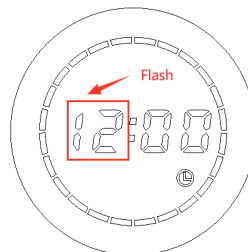

(4.5)

**4.5.1 Timing:** Long press  (3 seconds) to adjust time (4.5.1-1).





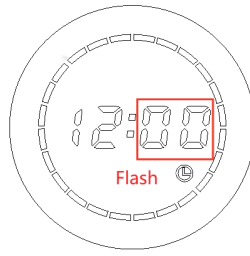

(4.5.1-1)

Press  or  shortly to adjust **Hour**, adjustable range 0~23H, 1H per skip, Long press  or  can accelerate skip. The Product should come into the Minute setting, if no any operation within 30 seconds).

Or, press  shortly after Hour setting, **Minute** "00" should flash (0.5 second per flash), as the image (4.5.1-2)



(4.5.1-2)



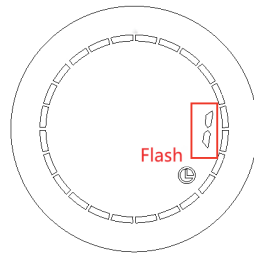

Press  or  shortly to adjust Minute, adjustable range 0~59 Min, 1 Min per skip, Long press  or  (1 second) can speed up skip.

Press  shortly after Minutes setting, product can switch into Day setting (or no any operation within 30 Seconds).

**4.5.2 Day Setting:** The last digital should flash (0.5 second per flash), as the image (4.5.2)



(4.5.2)

Press  or  shortly to set current start using Day, adjustable range 1~7 Day, 1 Day per skip, Long press  or  (1 second) can speed up skip, 1=Monday, 2=Tuesday, 3= Wednesday, 4=Thursday,5=Friday, 6= Saturday, 7=Sunday.

Under Day Comfort Mode to Press  shortly, can switch into One Week setting View. (Or, without any operation within 30 seconds)

**4.5.3 Week Timer View:**

Press  shortly to view Days' setting of one week, as the image (4.5.3-1).

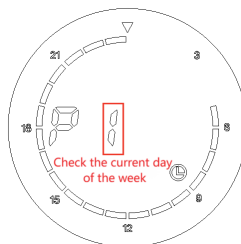

(4.5.3-1)

On the time axis display (■) on behalf of "Comfort Mode" running ,display □ (blank) on behalf of "ECO Mode" running. The product default heating time should be as the image (4.5.3-2), heating time 5:00~ 23:59 under Day Model,24:00~4:59 under ECO Mode, during from Monday to Sunday.

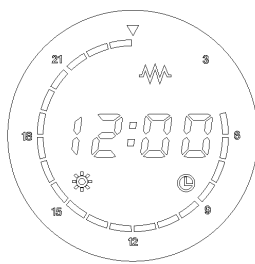



(4.5.3-2)



After Monday's program setting view, press **MENU** shortly to view Tuesday's program..... until to Sunday's.



Then, press **MENU** shortly can switch into Working Status (Or, no any operation within 30 seconds)

Long press **MENU** (3 Seconds) can switch into Weekly setting.



#### 4.5.4 Week Timer Setting:

Press  or  shortly to adjust Week Timer, press  shortly for the purpose of "Comfort Mode"

running,  light on 3 seconds, and then light off 1 second; Press  shortly for "ECO Mode" running, 

light off 3 seconds, and then light on 1 second. Per short press  or  with one hour change, the corresponding time light on, until to 23H, then recycle.

**For example:** to set from 7:00 to 23:59 Monday as Comfort Mode, Long press **MENU** (3 seconds) when "1" show

as Monday program, then press  from 7:00 to 23:00 scale, press  for the other Hours at ECO Mode running as the image (4.5.4).

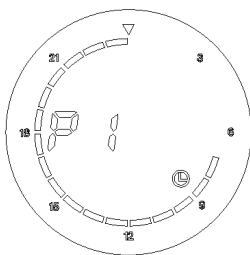

(4.5.4)

Press **MENU** shortly to exit "Current Day" setting, to continue set the other days' program .

Note: product should exit from Week Timer setting, if no any operation within 30 seconds

#### 4.5.5 Working Status: under heating status, display the set working time.

 Light on 3 seconds, Light off 1 second, on behalf of Comfort Mode status.

 Light off 3 seconds, Light on 1 second, on behalf of ECO Mode status.

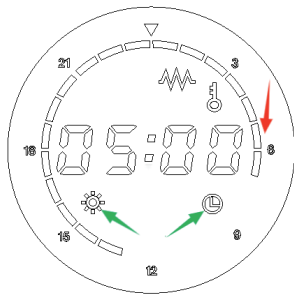

For example, as the image (4.5.5): time is 05:08, Day and Timing Mode light on, time axis  3 Seconds, off 1 second



In the Week Timer, press  shortly can switch into Boost mode.

(4.5.5)

**4.6 Boost Mode:** This mode can provide continuous heating from 1H to 8H (default heating is 2 hours), press

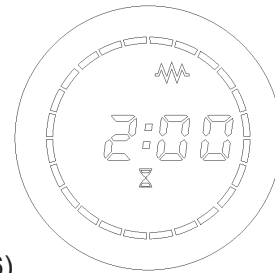

 or  shortly to set heating time. 1H per skip, Long press  or  can accelerate skip, Ten the



device begins a countdown for continuous heating. As the image (4.6)

(4.6). After the

timed heating time is over, the appliance returns to Standby state.

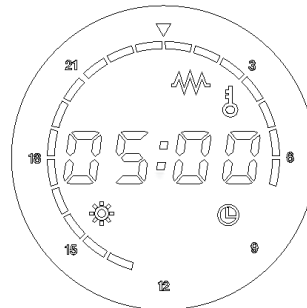

**5.1 Key Lock Mode** : Under Operating mode status, press  and  together (3 Seconds), the screen



should come into Key Lock Mode, as the image (5.1)

(5.1)



User should be unable to operate any key (except for On/Stand-By). The key can be unlocked through pressing

 and  together again (3 seconds).

**5.2 Parameter set:** Under Standby status, press  10 Seconds, to enter into Parameter setting., Then

press  shortly to switch modes. Temperature Tolerance(F0) → Windows Open function (F1).

**5.2.1: Temperature Tolerance Correction (F0):** The default temperature tolerance correction should be -2°C by factory as the image (5.2.1).

**Tolerance Correction:** Through pressing  or  shortly, can set temperature tolerance correction range(+5 /-5°C), 1°C Per Skip.

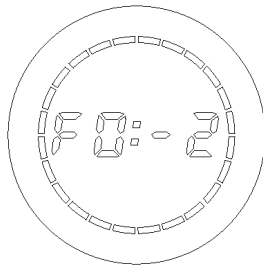

(5.2.1)

**5.2.2: Window Open set (F1)**, to press  or  shortly, can set Window Open Mode's working time, there are three durations for selection "0", "60", "90".

"0" on behalf of "Window Open" Mode OFF

"60" on behalf of "stop working 60 minutes

"90" on behalf of stop working 90 minutes

Provided product was set at 60, should display as the image (5.2.2-1).

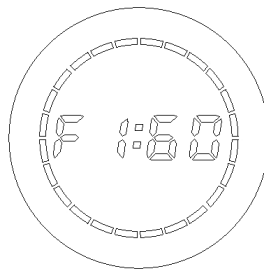

(5.2.2-1)

Under the heating status, when ambient temperature suddenly drop 5°C within five minutes, product can enter into Window Open Mode automatically, display as the image (5.2.2-2), working at fixed temperature 10°C and stop heating 60 minutes, then back to normal set Mode.

Provided the ambient temperature drop 5°C again within five minutes should re-enter into Window Open Mode, working at fixed temperature 10°C and stop heating 60 minutes, then back to normal set Mode, and recycle.

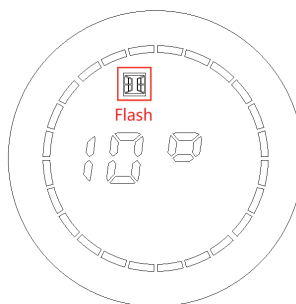

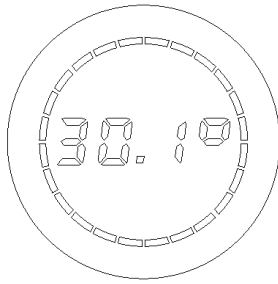

(5.2.2-2)

**5.3 Read the ambient temperature:** Under the Standby status, press  3 seconds to sense and display current ambient temperature on screen, as the image (5.3)



(5.3)

**5.4 Reset** : Under the Power ON condition, Long press  (about 10 seconds), “factory setting” can be recovery, after the whole screen display 3 seconds, can enter into Standby state.

And then press  on , the initial setting data by factory can be displayed on screen as: 19°C(Comfort Mode), 15°C( ECO Mode) 12:00(Time), 1(Monday), -2(temperature tolerance correction),0(Window Open Mode OFF), and the Week Timer back to default data.

#### Explanation of Abnormal Codes:

Phenomenon	Indication
Temperature sensor open circuit	Display Er
Temperature sensor short circuit	Display Er