

(DE) Montageanleitung (FR) Instructions de montage (IT) Istruzioni per il montaggio
 (NL) Montagehandleiding (SE) Monteringsanvisning (CZ) Návod k montáži
 (SK) Návod na montáž (RO) Instrucțiuni de montare

Erato Hybrid

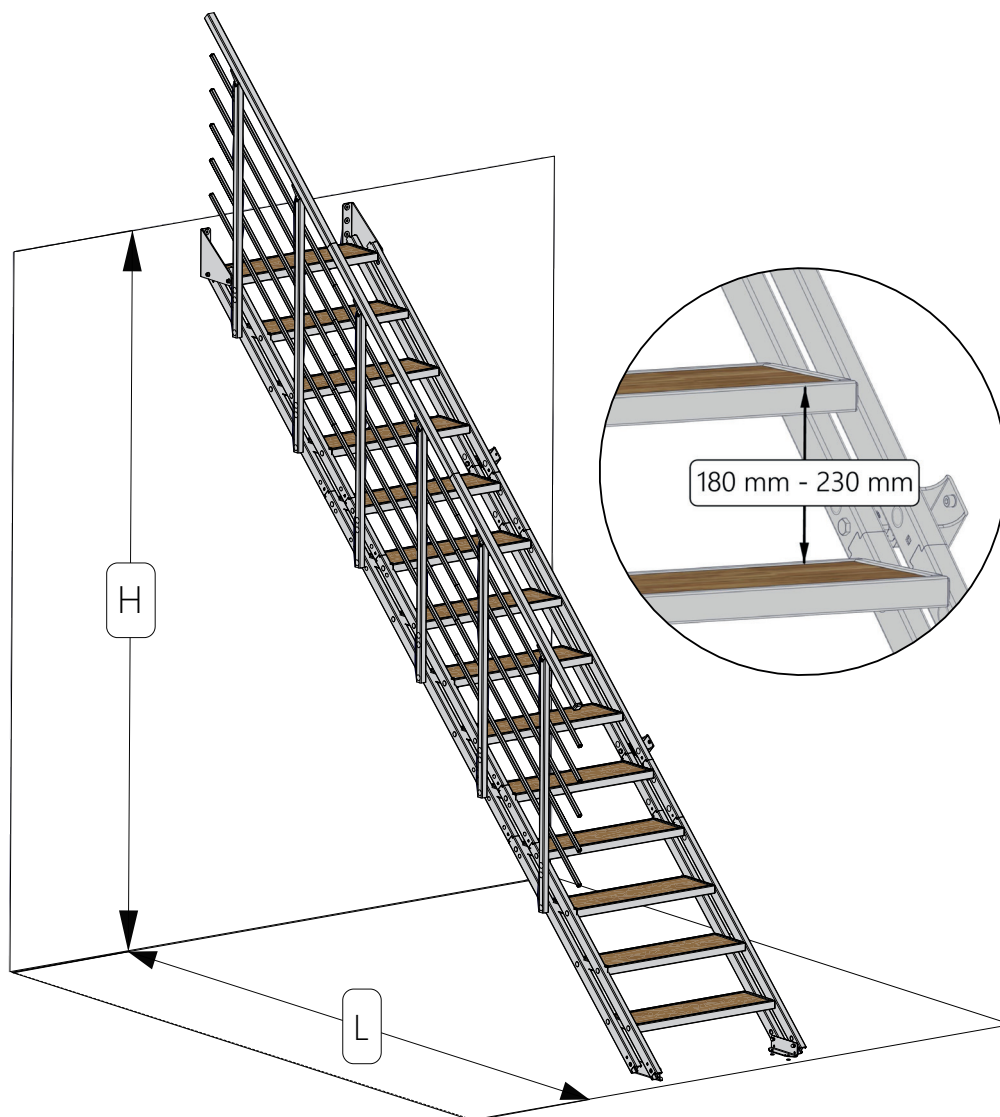

	STEPS	H [mm]	L [mm]	S [mm]
A	4+1	915 – 1150	1090 – 912	180 – 230
	5+1	1095 – 1380	1330 – 1090	180 – 230
	6+1	1275 – 1612	1560 – 1270	180 – 230
B	8+1	1635 – 2072	2020 – 1630	180 – 230
	9+1	1815 – 2302	2250 – 1809	180 – 230
	10+1	1995 – 2532	2477 – 1990	180 – 230
C	12+1	2355 – 2992	2937 – 2350	180 – 230
D	13+1	2532 – 3222	3170 – 2530	180 – 230
	14+1	2715 – 3452	3400 – 2710	180 – 230





DE Sicherheitshinweise

SE Säkerhetsanvisningar

NL Veiligheidsinstructies

RO Instrucțiuni de siguranță

SK Bezpečnostné pokyny

IT Avvertenze di sicurezza

FR Consignes de sécurité

CZ Bezpečnostní pokyny

DE Ein Einbau muss vorab immer von der zuständigen Behörde geklärt werden. Für die Güte unserer Materialien garantieren wir im Rahmen unserer Allgemeinen Geschäftsbedingungen. Die Anwendung unserer Produkte darf nur durch Fachleute und/oder versierte, fachkundige und entsprechend handwerklich begabte Personen erfolgen. Der Anwender kann nicht von einer Rückfrage bei Unklarheiten sowie einer fachmännischen Verarbeitung entbunden werden. Naturgemäß können nicht alle möglichen, gegenwärtigen und zukünftigen Anwendungsfälle und Besonderheiten lückenlos beinhaltet sein. Die geltenden, technischen, nationalen und europäischen Normen, Richtlinien und Merkblätter betreffend Materialien, Untergrund und nachfolgendem Aufbau beachten! Gegebenenfalls Bedenken anmelden. Mit Herausgabe einer neuen Version verliert diese ihre Gültigkeit. Die jeweils neueste Anleitung ist im Internet abrufbar.

Achtung: Vor der Montage der Treppe muss der Untergrund auf das Vorhandensein von Fußbodenheizungen, elektrischen Leitungen oder anderen Installationen überprüft werden. Der Hersteller übernimmt keine Haftung für Schäden, die durch unsachgemäßes Bohren entstehen. Konsultieren Sie im Zweifelsfall einen Fachmann.

IT L'installazione deve sempre essere preliminarmente accertata dalle autorità competenti. Garantiamo la qualità dei nostri materiali nell'ambito delle nostre condizioni contrattuali. L'utilizzo dei nostri prodotti è consentito esclusivamente a personale adeguatamente qualificato, esperto e/o specializzato. L'utilizzatore non può essere dispensato dal reperimento di informazioni in caso di dubbi e dal richiedere l'intervento da parte di personale tecnico. Naturalmente, non possono essere completamente incluse tutte le possibili applicazioni, presenti e future, né le specifiche peculiarità. È necessario osservare le norme tecniche, le direttive e i foglietti illustrativi vigenti sia a livello nazionale che europeo, relativamente ai materiali, alla base di installazione e al successivo montaggio! È necessario segnalare eventuali dubbi o perplessità. La validità della presente versione decade in seguito alla pubblicazione di una nuova versione. Le istruzioni in vigore sono consultabili online.

Attenzione: prima del montaggio della scala è necessario verificare che non siano presenti impianti di riscaldamento a pavimento, cavi elettrici o altre installazioni. Il produttore non si assume alcuna responsabilità per danni causati da una perforazione impropria. In caso di dubbio, consultare un esperto.

FR Un montage doit toujours être préalablement clarifié par les autorités compétentes. Nous garantissons la qualité de nos matériaux selon nos conditions générales de vente. Nos produits doivent être utilisés uniquement par des spécialistes et/ou des personnes expérimentées, compétentes et douées pour le travail artisanal. En cas de question ou d'installation professionnelle, la responsabilité de l'utilisateur ne peut être remise en cause. Naturellement, il est impossible de mentionner sans exception toutes les situations d'utilisation et particularités possibles présentes et futures. Respecter les normes, directives et fiches techniques en vigueur, spécialisées, nationales et européennes concernant les matériaux, les supports et l'installation qui en est faite ! Faire part d'éventuelles inquiétudes si nécessaire. Cette version devient caduque avec la publication d'une nouvelle version. Chaque nouvelle version de la notice est disponible sur Internet.

Attention: avant la pose de l'escalier, vérifier la présence de chauffage par le sol, de câbles électriques ou d'autres installations sur le support. Le fabricant décline toute responsabilité en cas de dommages liés à un perçage incorrect. En cas de doute, consultez un spécialiste.

NL Installatie moet altijd vooraf door de bevoegde autoriteit worden verduidelijkt. Wij garanderen de kwaliteit van onze materialen in het kader van onze algemene voorwaarden. Onze producten mogen alleen gebruikt worden door specialisten en/of ervaren, competente en vakbekwame personen. De gebruiker kan niet ontheven worden van vragen in geval van onduidelijkheden of van professionele verwerking. Uiteraard kunnen niet alle mogelijke, huidige en toekomstige gebruikssituaties en bijzonderheden volledig opgenomen worden. Neem de geldende technische, nationale en Europese normen, richtlijnen en gegevensbladen met betrekking tot materialen, ondergrond en de opbouw in acht! Meld zorgen indien nodig. Wanneer een nieuwe versie wordt uitgegeven, verliest deze versie zijn geldigheid. De meest recente handleiding is beschikbaar op het internet.

Let op: voordat de trap wordt geplaatst, dient de ondergrond gecontroleerd te worden op de aanwezigheid van vloerverwarming, elektrische leidingen of andere installaties. De fabrikant aanvaardt geen aansprakelijkheid voor schade die is ontstaan door ondeskundig boren. Neem in geval van twijfel contact op met een vakman.



DE Sicherheitshinweise

SE Säkerhetsanvisningar

NL Veiligheidsinstructies

RO Instrucțiuni de siguranță

SK Bezpečnostné pokyny

IT Avvertenze di sicurezza

FR Consignes de sécurité

CZ Bezpečnostní pokyny

CZ Montáž musí být vždy předem prodiskutována s příslušným úřadem. Záruka na kvalitu našich materiálů platí v rámci našich Všeobecných obchodních podmínek. Naše produkty smejí používat pouze odborníci a/nebo osoby, které jsou v používání zblhlé, mají pro něj odborné znalosti nebo příslušnou řemeslnou způsobilost. Uživatel se musí v případě nejasností zeptat a využít odborného zpracování. Samozřejmě není možné, aby byly beze zbytku obsaženy všechny možné, současné a budoucí případy použití a zvláštnosti. Dodržujte platné technické, tuzemské a evropské normy, směrnice a datové listy v ohledu na materiály, podklad a následnou montáž! V případě pochybností nás kontaktujte. Při uveřejnění nové verze pozbývá platnosti předchozí verze. Nejnovější návod je k dispozici na Internetu.

Pozor: před montáží schodů musí být zkontrolován podklad na přítomnost podlahového vytápění, elektrických rozvodů či dalších instalačních rozvodů. Výrobce nepřebírá ručení za škody, které vzniknou v důsledku neodborně provedeného vrtání. V případě pochybností se poradte s odborníkem.

SK Montáž musí byť vždy vopred prediskutovaná s príslušným úradom. Za kvalitu našich materiálov ručíme v rámci našich všeobecných obchodných podmienok. Montáž našich produktov môžu vykonávať iba odborníci a/alebo skúsené a náležite kvalifikované osoby s odbornými znalosťami. Používateľ nemôže byť zbavený povinnosti konzultácie v prípade nejasností, ako aj odborného spracovania. Prírodnene, nie je možné zahrnúť úplne všetky mysliteľné, súčasné a budúce možnosti použitia, ako aj osobitosti produktu. Je potrebné dodržiavať platné technické, národné a európske normy, smernice a technické listy týkajúce sa materiálov, podkladu a následnej konštrukcie! V prípade potreby vyjadrite svoje pochybnosti. Vydaním novej verzie stráca táto verzia platnosť. Najnovšia verzia návodu je k dispozícii na internete.

Pozor: Pred montážou schodov je potrebné skontrolovať podklad, či sa v ňom nenachádza podlahové kúrenie, elektrické vedenie alebo iné inštalácie. Výrobca nezodpovedá za škody, ktoré vzniknú v dôsledku nesprávneho vrtania. V prípade pochybností sa poradte s odborníkom.

SE Kontakta alltid behörig myndighet innan installation. Vi garanterar kvaliteten på det använda materialet inom ramen för våra Allmänna affärsvillkor. Våra produkter får endast användas av behöriga eller motsvarande hantverkskunniga personer. Användaren kan inte befrias från ytterligare frågor vid oklarheter eller från fackmannamässig hantering. Av naturliga skäl kan inte samtliga möjliga, samtida och framtida tillämpningar och specialfall täckas. Gällande tekniska, nationella och europeiska normer, riktlinjer och referensdokument vad gäller material, underlag och efterföljande montering ska iakttagas! Anmäl eventuella betänkligheter. När en ny version publiceras upphör denna version att gälla. De senaste anvisningarna finns att hämta på internet.

Obs! Innan trappan monteras ska underlaget kontrolleras med avseende på eventuell golvvärme, elektriska ledningar och andra installationer. Tillverkaren tar inget ansvar för skador som uppstår på grund av felaktigt utfört borrhande. Vid tveksamhet, rådfråga en fackman.

RO Montajul trebuie clarificat întotdeauna în prealabil de către autoritatea responsabilă. În cadrul condițiilor generale de vânzare garantăm pentru calitatea materialelor noastre. Utilizarea produselor noastre poate fi realizată doar de specialiști și/sau persoane cu experiență, cunoștințe și calificare corespunzătoare. Utilizatorul nu poate fi exonerat de responsabilitate în caz de neclarități, precum și de prelucrarea profesională. În mod firesc, nu pot fi prevăzute absolut toate cazurile de utilizare și particularitățile posibile, actuale și viitoare. Trebuie respectate normele tehnice, naționale și europene în vigoare și fișele tehnice cu privire la materiale, suprafețe și montaj! În caz de neclarități, acestea trebuie comunicate. Prin publicarea unei versiuni noi, prezenta versiune își pierde valabilitatea. Cea mai nouă versiune a instrucțiunii poate fi accesată în InfoNet.

Atenție: Înainte de montarea scării, trebuie verificat dacă sub pardoseală există încălzire prin pardoseală, cabluri electrice sau alte instalații. Producătorul nu își asumă nicio răspundere pentru daunele cauzate de găurirea necorespunzătoare. În cazul în care aveți îndoieli, consultați un specialist.



Ⓓ Konfigurationen

Ⓐ Configurazioni

Ⓚ Konfigurationer

Ⓕ Konfigurácie

Ⓔ Configurations

Ⓡ Configuraties

Ⓜ Konfigurace

Ⓒ Configurații

A

4+1 STEPS

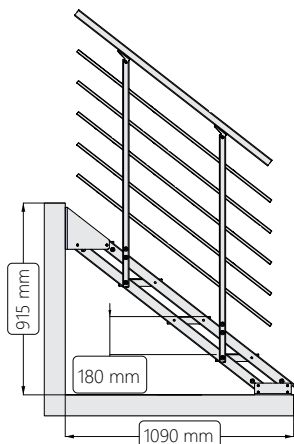
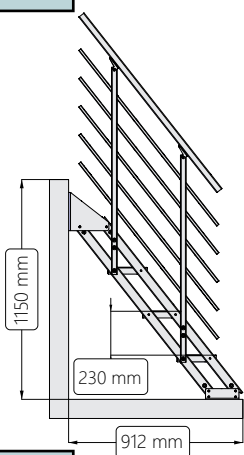

A

5+1 STEPS

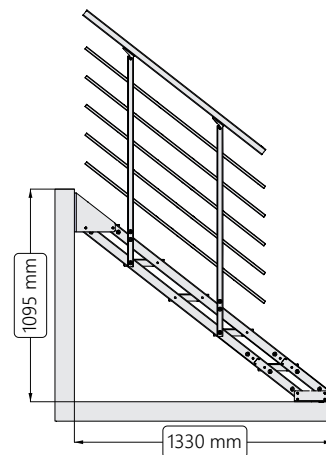
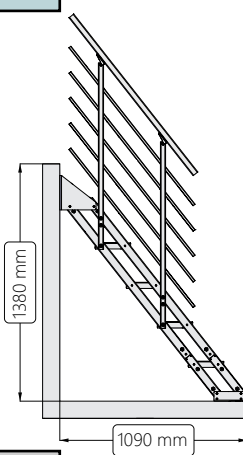

A

6+1 STEPS

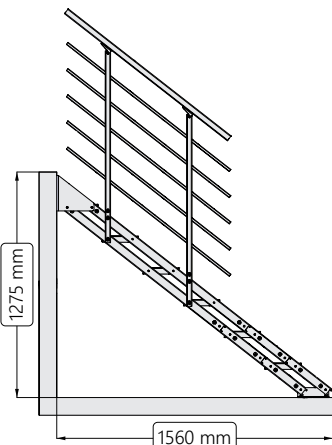
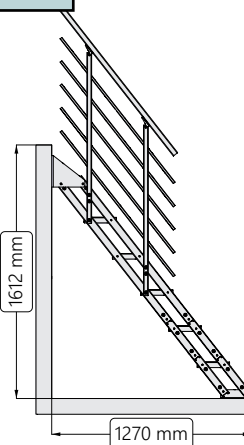

B

8+1 STEPS

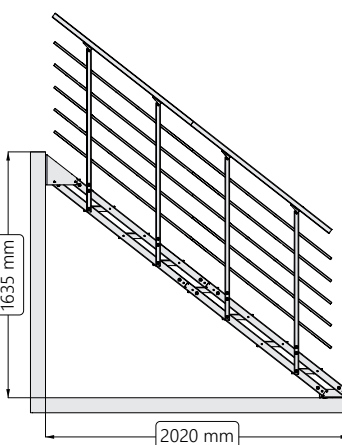
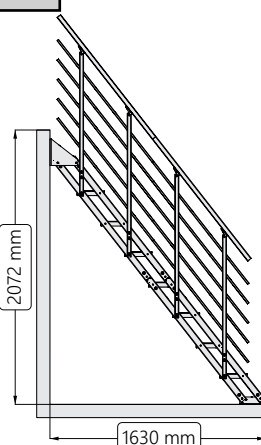

B

9+1 STEPS

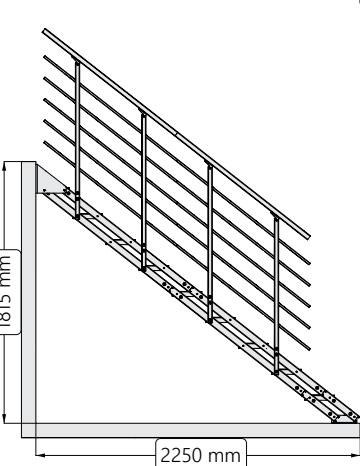
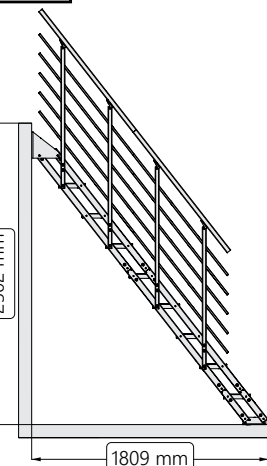

B

10+1 STEPS

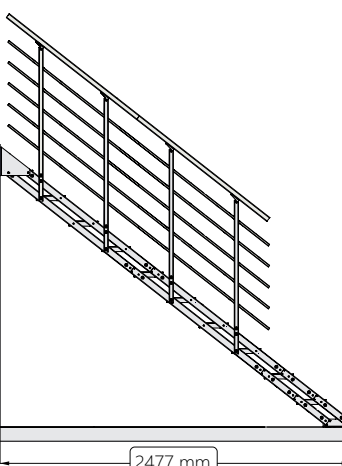
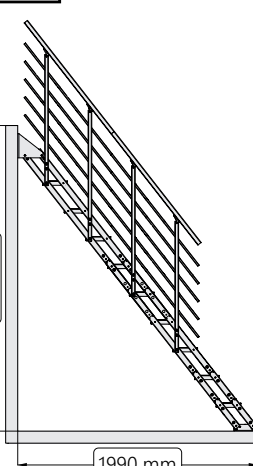



Ⓓ Konfigurationen

Ⓓ Configurazioni

Ⓓ Konfigurationer

Ⓓ Konfigurácie

Ⓓ Configurations

Ⓓ Configuraties

Ⓓ Konfigurace

Ⓓ Configurații

C

12+1 STEPS

D

13+1 STEPS

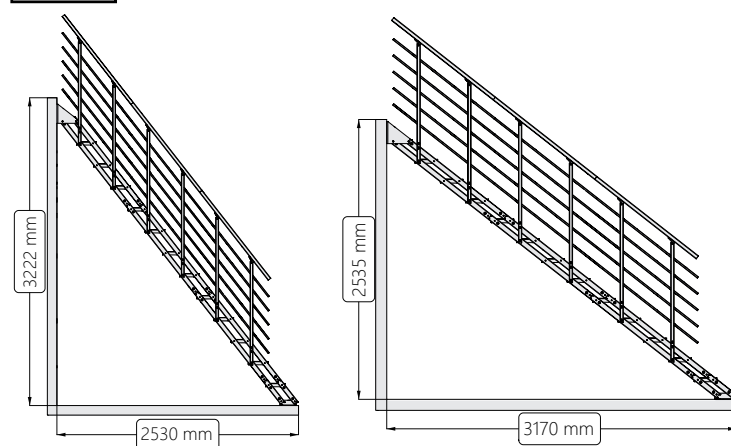
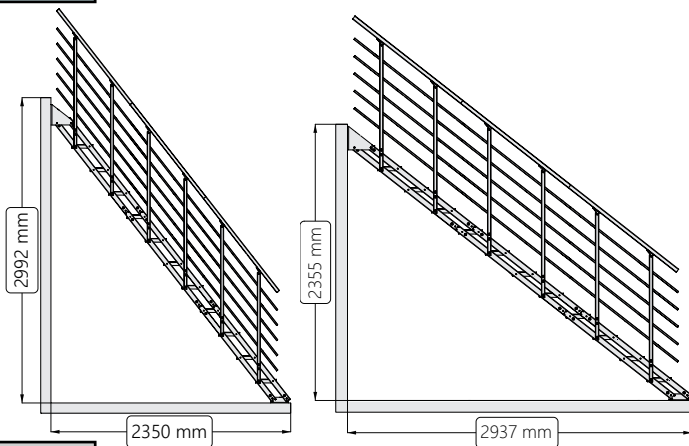

D

14+1 STEPS

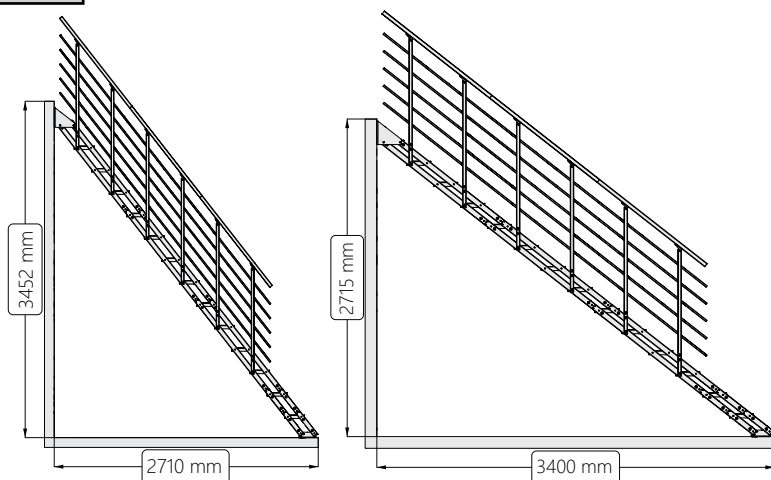



DE Lieferumfang

SE Contenu de la livraison

NL Fornitura

RO Leveringsomvang

SK Leveransinnehåll

IT Obsah dodávky

FR Obsah balenia

CZ Volumul de livrare

A=14x
B=14x
C=14x
D=14x

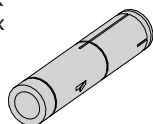

D01

Ø12mm

A=10x
B=10x
C=10x
D=10x

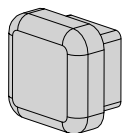

KS08

15x15mm

A=10x
B=10x
C=30x
D=30x

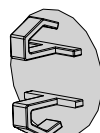

KS09

Ø13mm

A=30x
B=44x
C=42x
D=58x

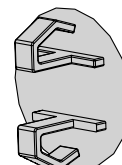

KS10

Ø20mm

A=2x
B=2x
C=2x
D=2x

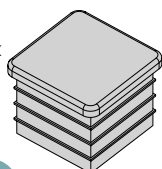

KS14

34x34mm

A=2x
B=4x
C=6x
D=6x

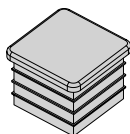

KS16

30x30mm

A=4x
B=4x
C=4x
D=4x

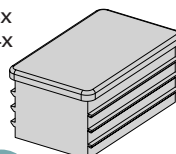

KS17

50x30mm

A=0x
B=5x
C=10x
D=10x

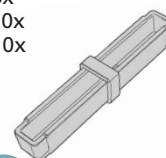

KS24

12x12x80mm

A=12x
B=20x
C=24x
D=28x

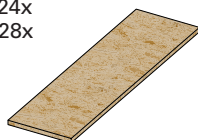

HS22

A=6x
B=10x
C=12x
D=14x



HS23

A=12x
B=34x
C=48x
D=48x

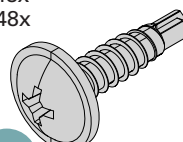

NT07

Ø4.2x19mm

A=26x
B=34x
C=26x
D=42x

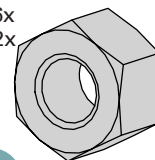

NT24

M8

A=74x
B=104x
C=110x
D=134x

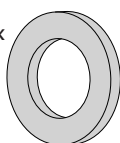

NT26

M8 DIN125A

A=6x
B=6x
C=6x
D=6x

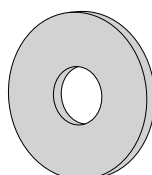

NT37

M8 DIN9021

A=16x
B=24x
C=16x
D=32x

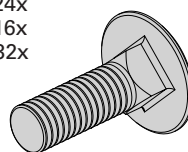

NT41

M8x25mm

A=12x
B=12x
C=12x
D=12x

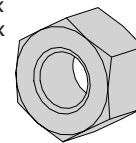

NT45

M6

A=12x
B=12x
C=12x
D=12x

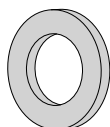

NT50

M6 DIN125A

A=30x
B=38x
C=24x
D=46x

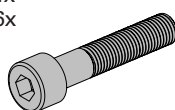

NT54

M8x55mm

A=12x
B=12x
C=12x
D=12x

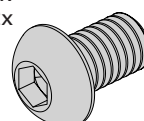

NT68

M6x10mm

A=22x
B=36x
C=42x
D=50x

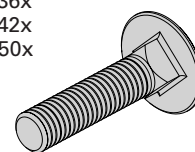

NT72

M8x40mm



DE Lieferumfang

NL Fornitura

SK Leveransinnehåll

FR Obsah balenia

SE Contenu de la livraison

RO Leveringsomvang

IT Obsah dodávky

CZ Volumes de livrare

A=0x
B=1x
C=2x
D=2x

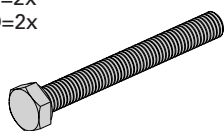

NT73 M8x90mm

A=32x
B=48x
C=52x
D=64x

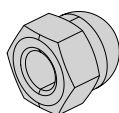

NT74 M8

A=6x
B=8x
C=10x
D=10x

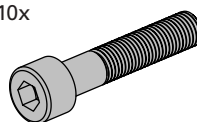

NT75 M8x40mm

A=4x
B=8x
C=12x
D=12x

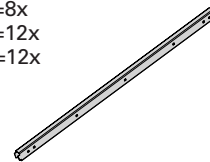

ST57

A=8x
B=8x
C=0x
D=8x

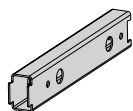

ST58

A=1x
B=1x
C=1x
D=1x

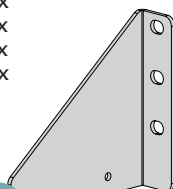

ST59

A=1x
B=1x
C=1x
D=1x

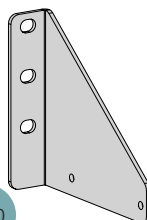

ST60

A=2x
B=2x
C=2x
D=2x

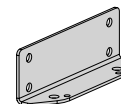

ST61

A=8x
B=12x
C=8x
D=16x

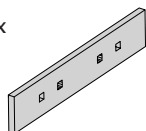

ST62

A=8x
B=12x
C=8x
D=16x

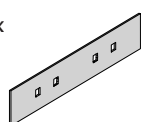

ST63

A=2x
B=4x
C=6x
D=6x

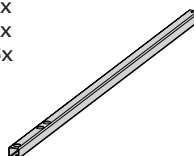

ST64 30x30x1085mm

A=1x
B=2x
C=3x
D=3x

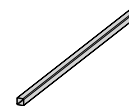

ST65 35x35x1168mm

A=5x
B=10x
C=15x
D=15x



ST66 15x15x1168mm

A=0x
B=1x
C=2x
D=2x

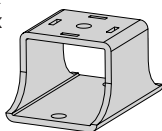

ST70

A=0x
B=1x
C=2x
D=2x

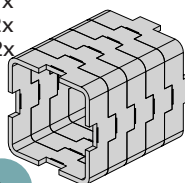

ST71

A=2x
B=4x
C=6x
D=6x

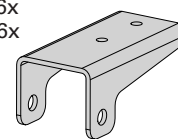

ST125

A=0x
B=1x
C=2x
D=2x

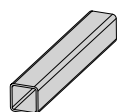

ST129 30x30x200mm

A=6x
B=10x
C=12x
D=14x

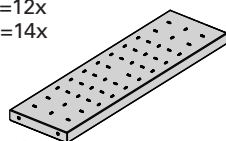

ST163



(DE) Benötigtes Werkzeug

(NL) Utensili necessari

(SK) Nödvändiga verktyg

(FR) Potrebne náradie

(SE) Outils nécessaires

(RO) Benodigd gereedschap

(IT) Potrebne náradí

(CZ) Unealtă necesară

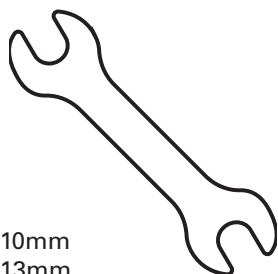

10mm
13mm

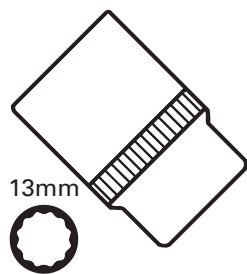

13mm

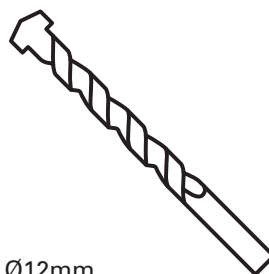

Ø12mm

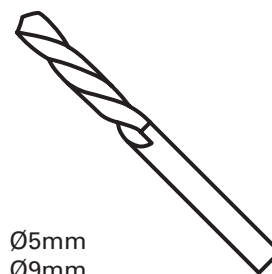

Ø5mm
Ø9mm

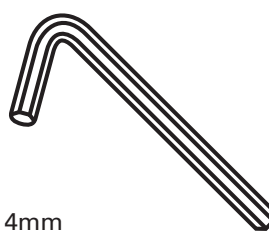
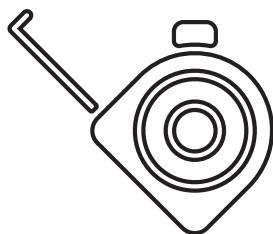
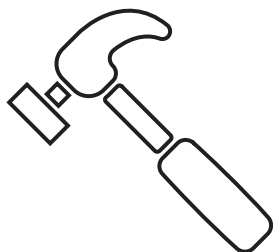

4mm
5mm

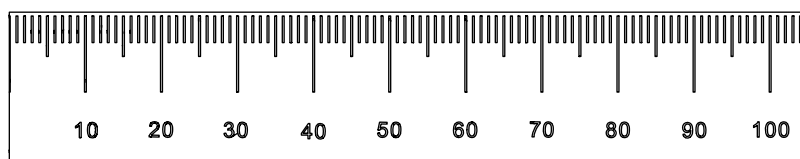
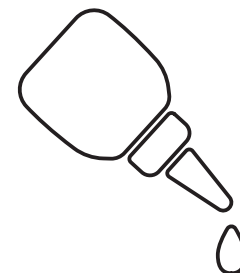
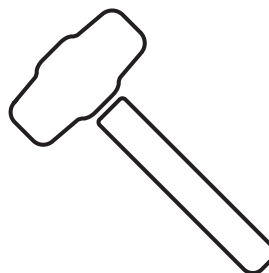
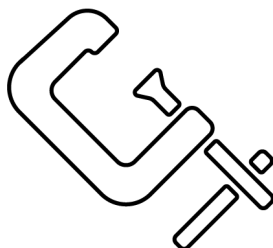
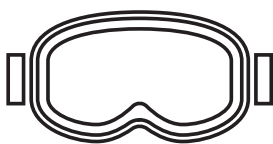
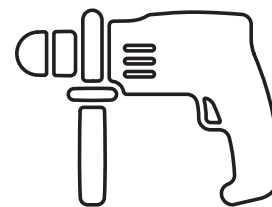
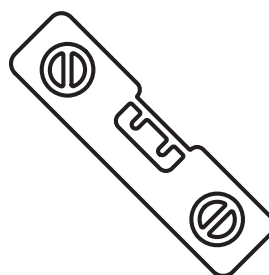
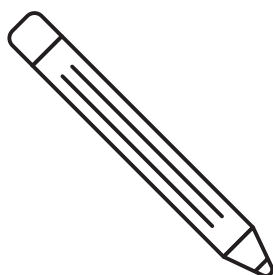
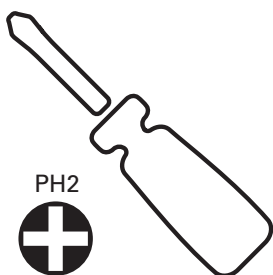
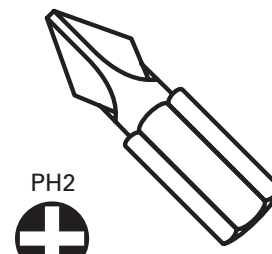



Ⓛ DE Vorbereitung

Ⓛ NL Preparazione

Ⓛ SK Förberedelser

Ⓛ FR Příprava

Ⓛ SE Préparation

Ⓛ RO Voorbereiding

Ⓛ IT Příprava

Ⓛ CZ Pregătirea

A

4+1 STEPS

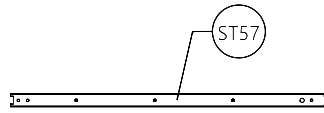

5+1 STEPS

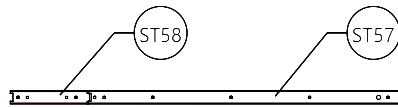

6+1 STEPS

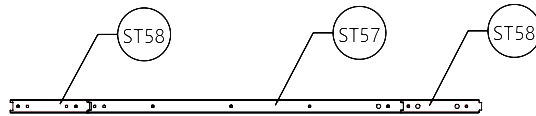

B

8+1 STEPS

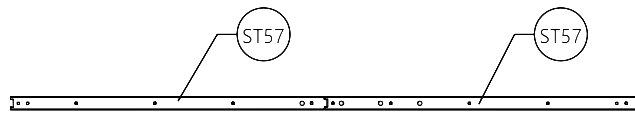

9+1 STEPS

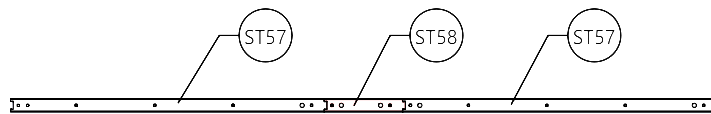

10+1 STEPS

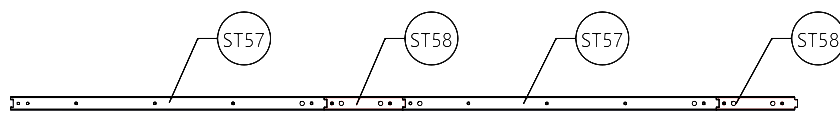

C

12+1 STEPS

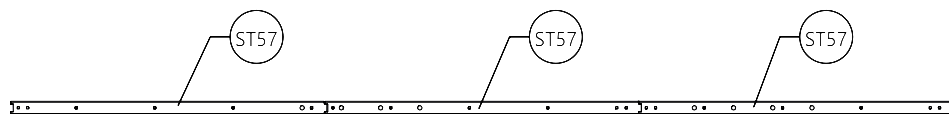

D

13+1 STEPS

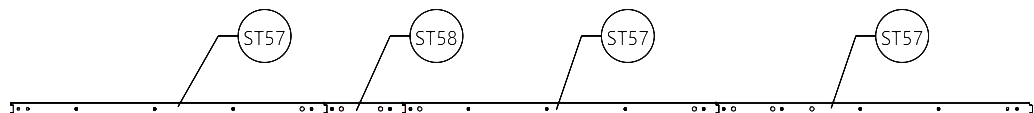

14+1 STEPS

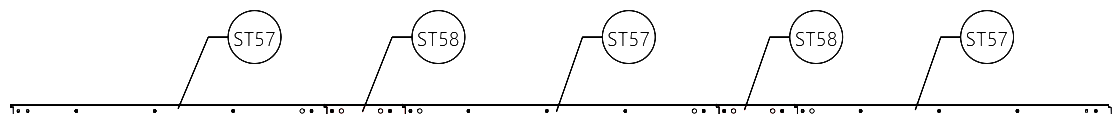



DE Beispiel

NL Voorbeeld

SK Příklad

FR Exemple

SE Exempel

RO Exemplu

IT Esempio

CZ Příklad

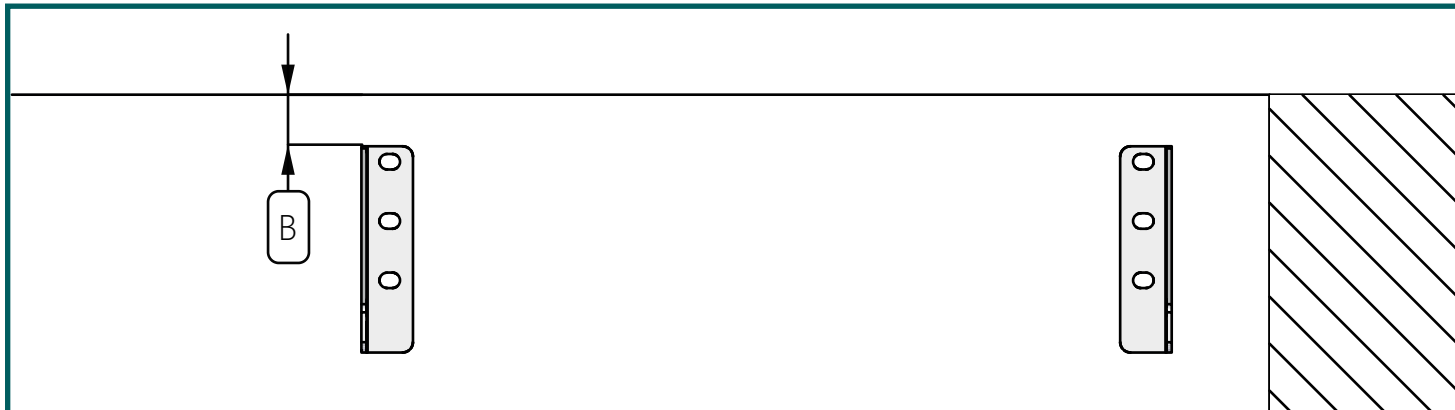

$$S(\text{mm}) = \frac{H}{n + 1}$$

$$B(\text{mm}) = \frac{H - S}{n} - 162.5$$

Steps = n = 1...14

$$H = 3000 \text{ mm} \quad n = 14$$

$$S(\text{mm}) = \frac{(H = 3000 \text{ mm})}{(n = 14) + 1} = 200 \text{ mm}$$

$$B(\text{mm}) = \frac{(H = 3000 \text{ mm}) - (S = 200 \text{ mm})}{(n = 14)} - 162.5 = 37.5 \text{ mm}$$

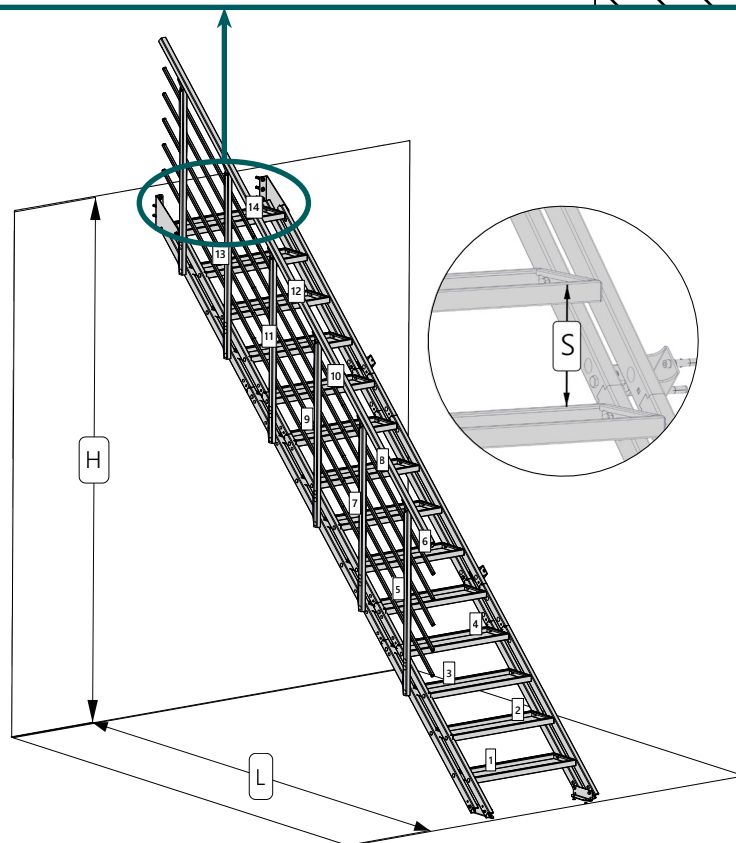

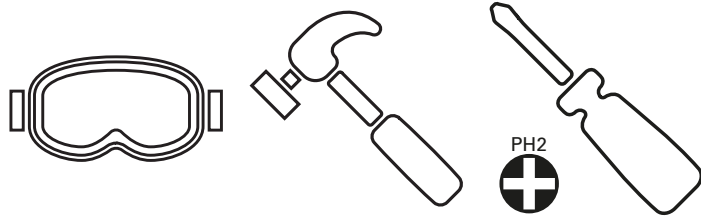

1

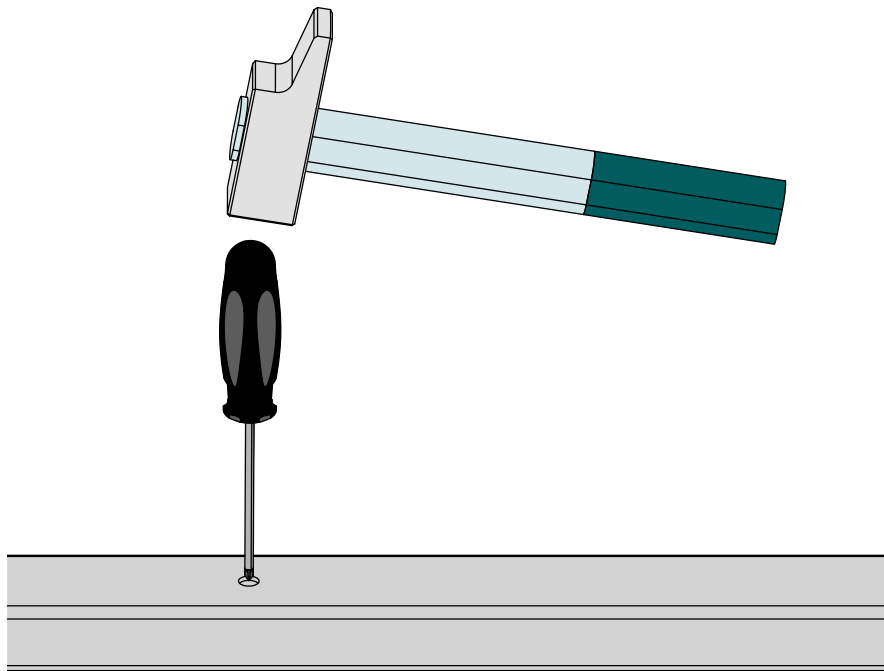
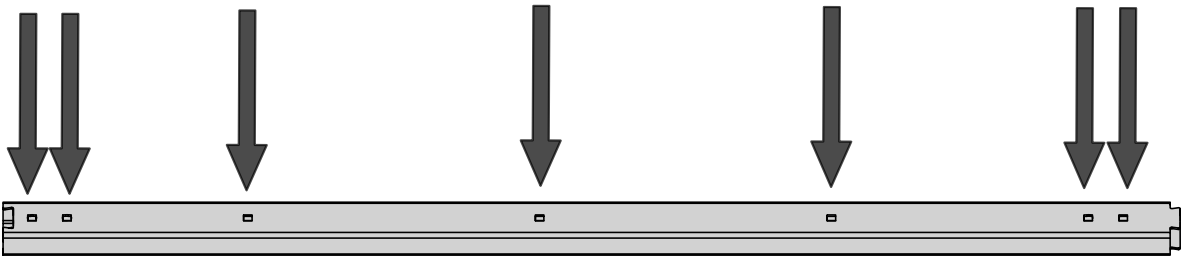
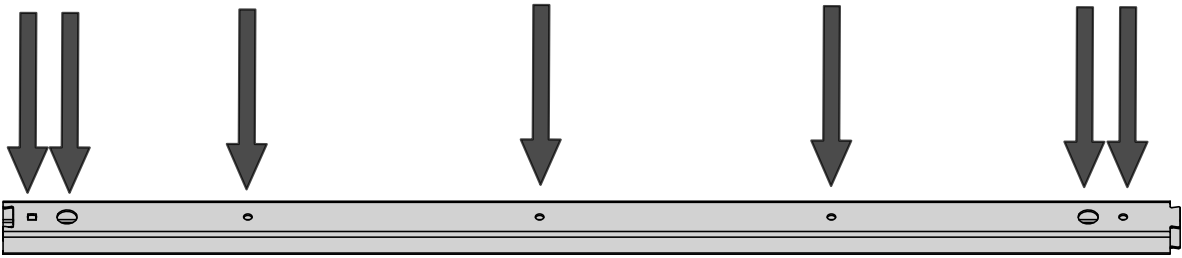

2

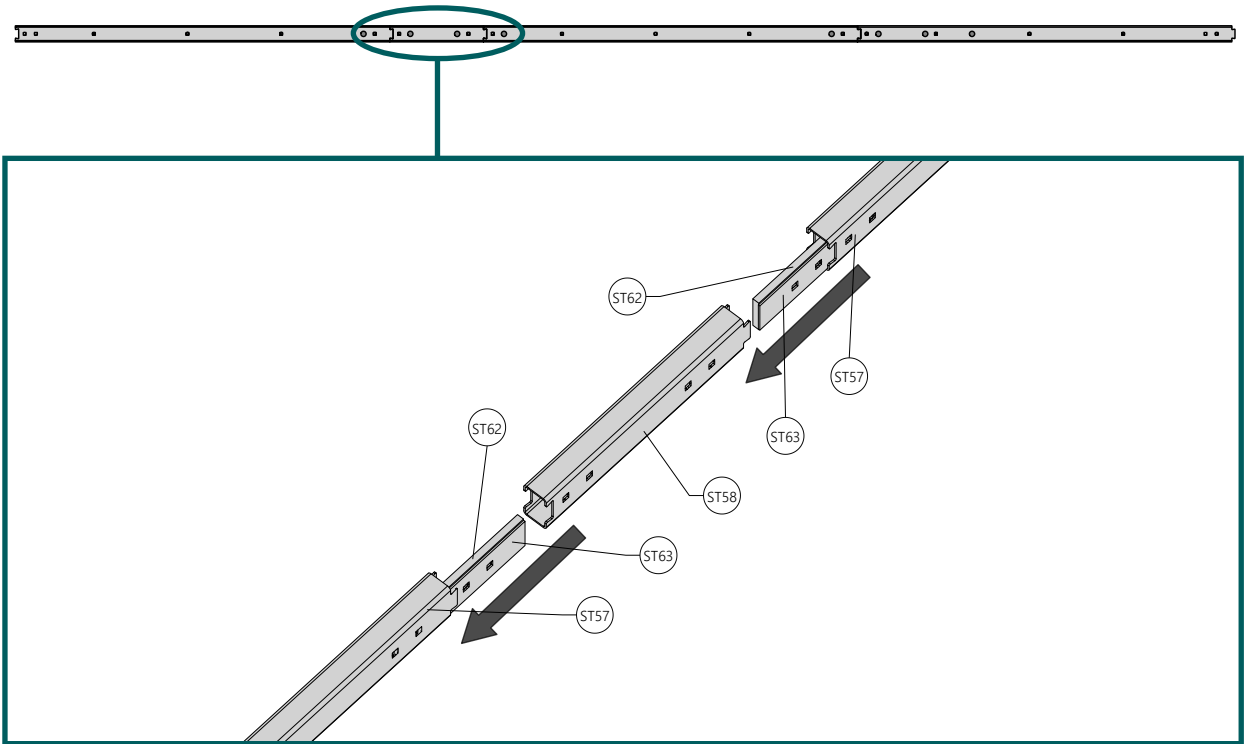

3

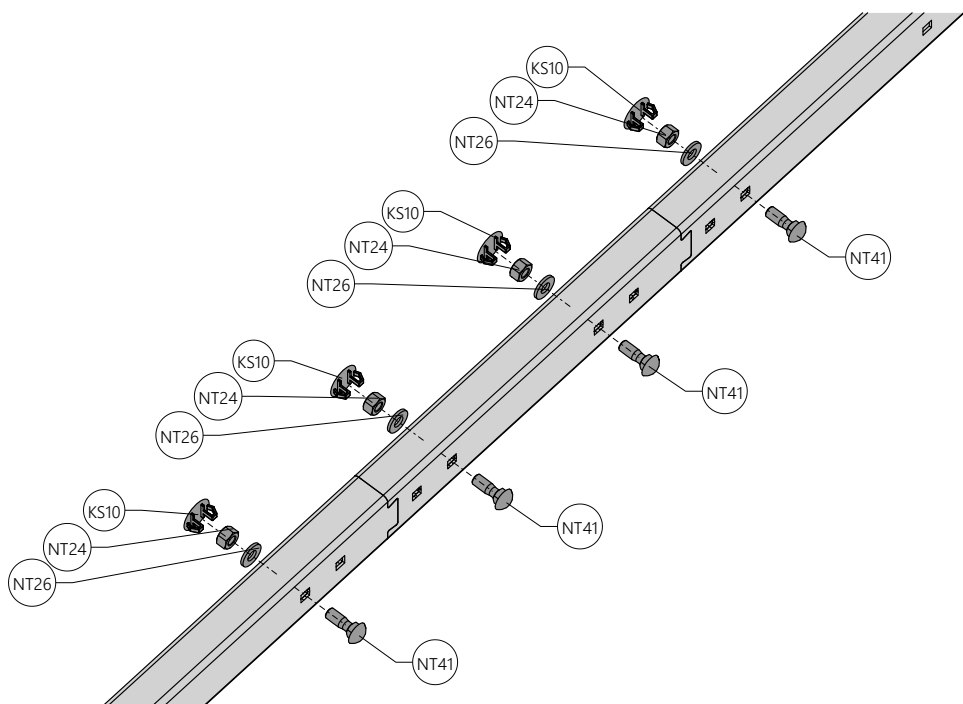
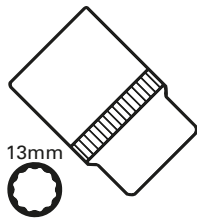

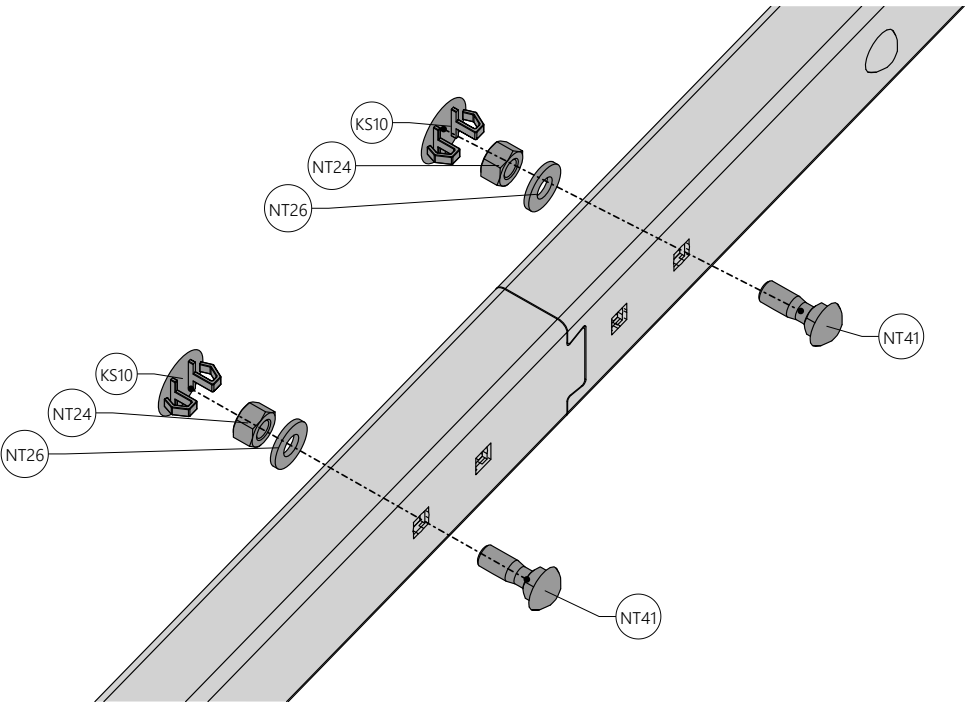
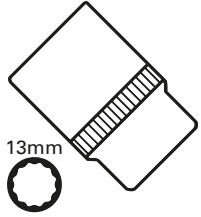
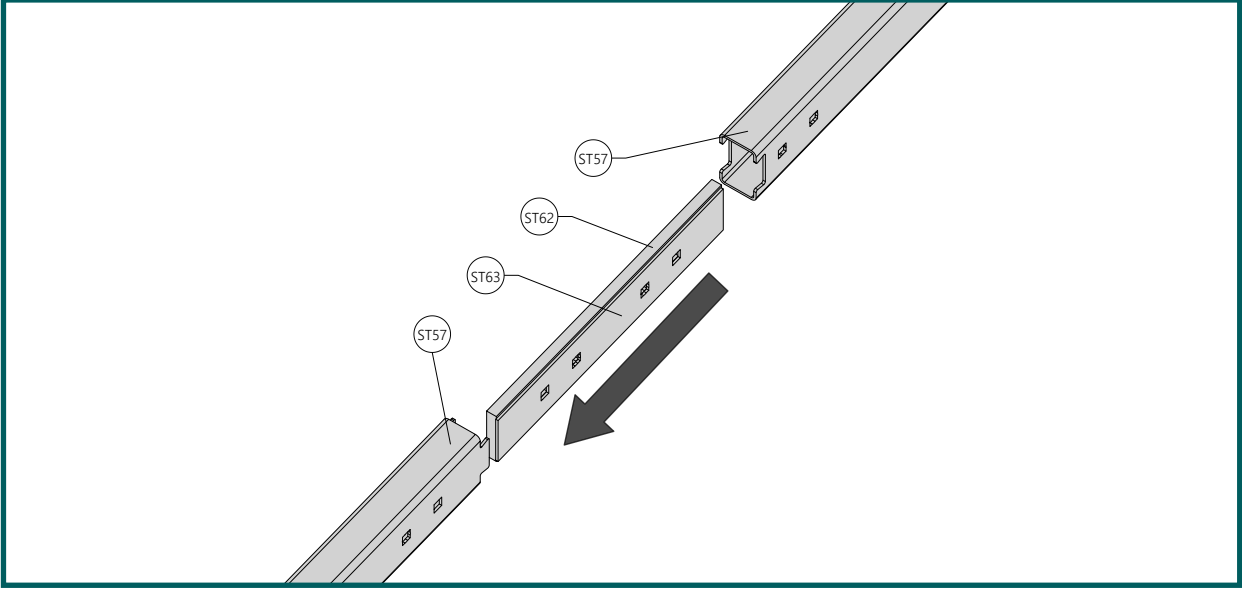
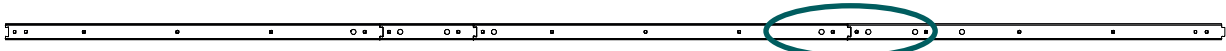

6

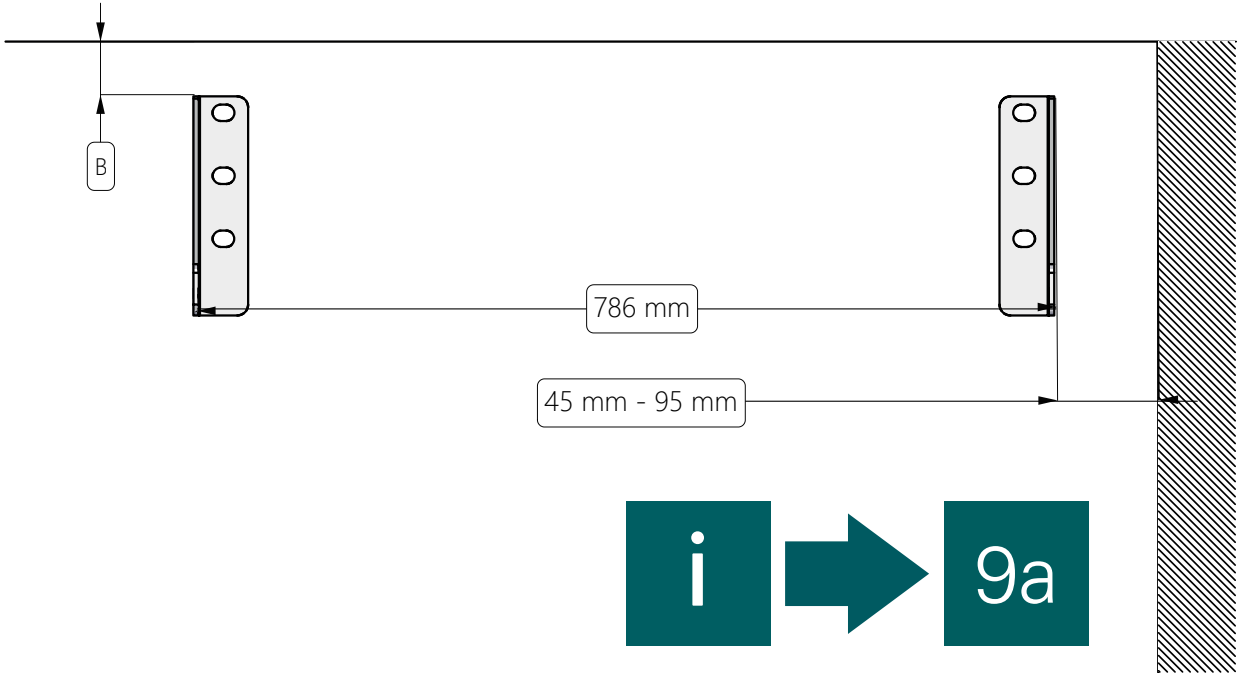
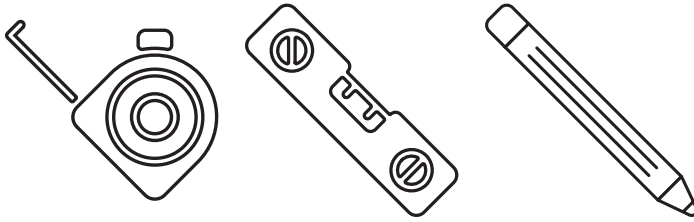

7

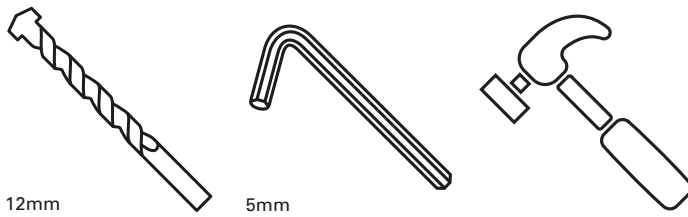

12mm

5mm

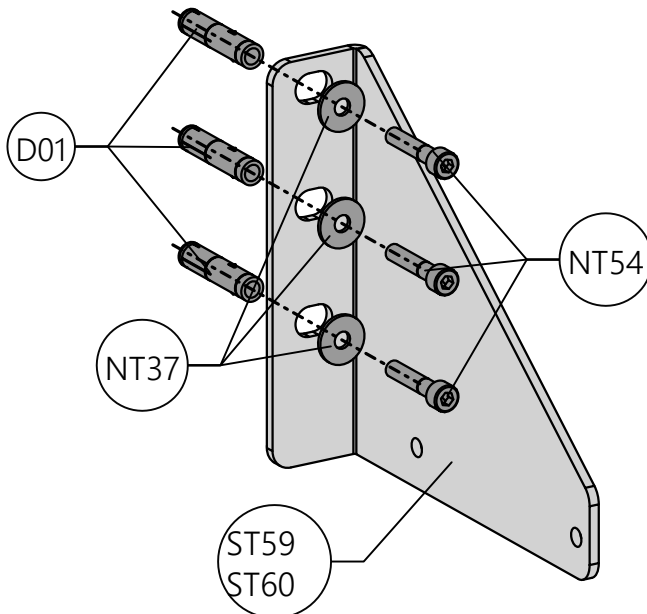
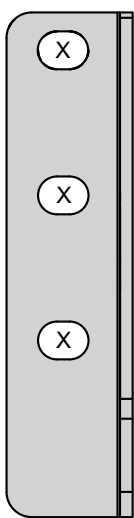

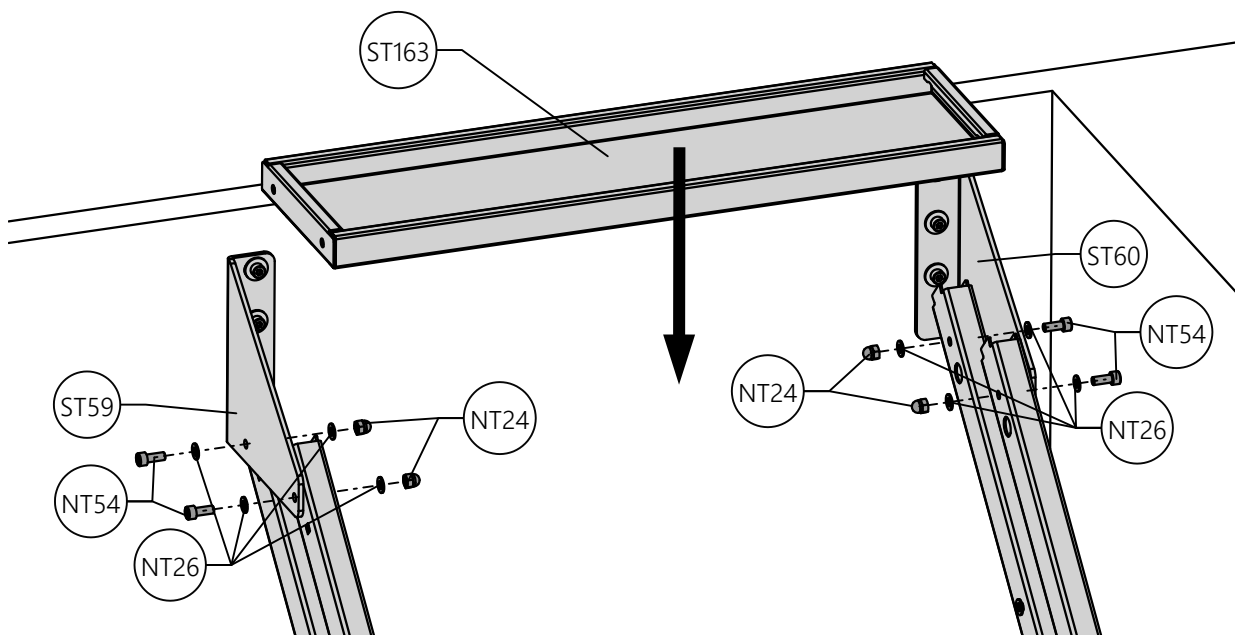
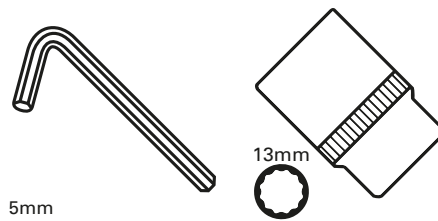
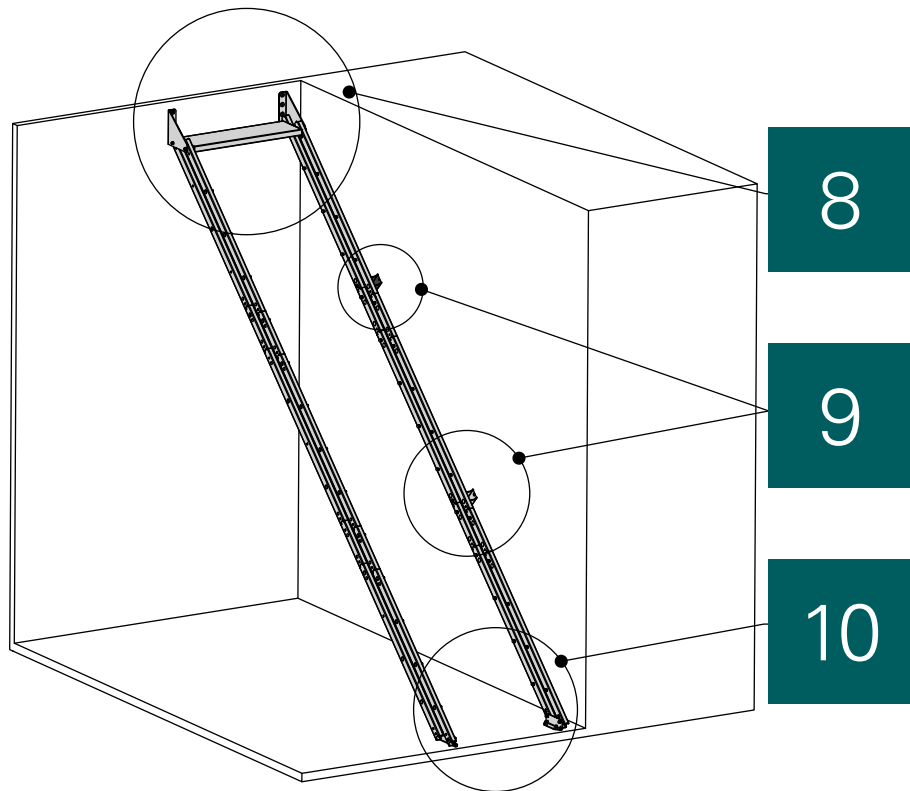

9a

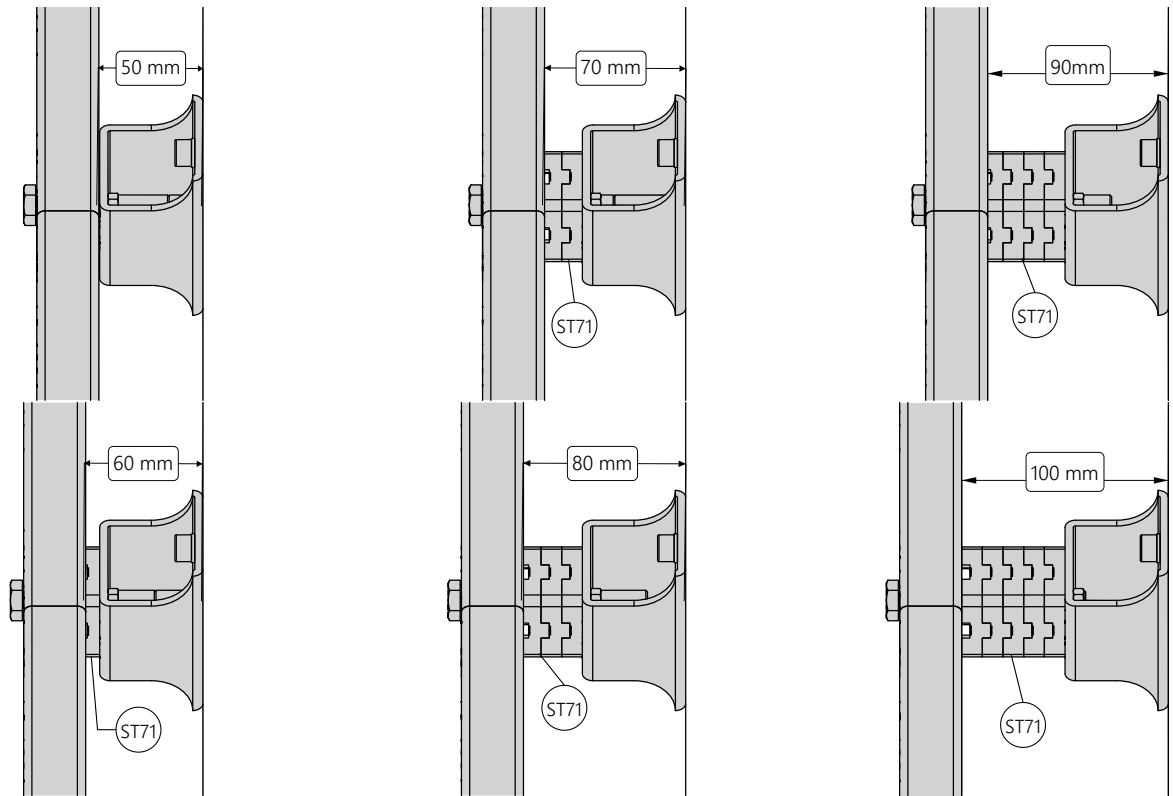

9b

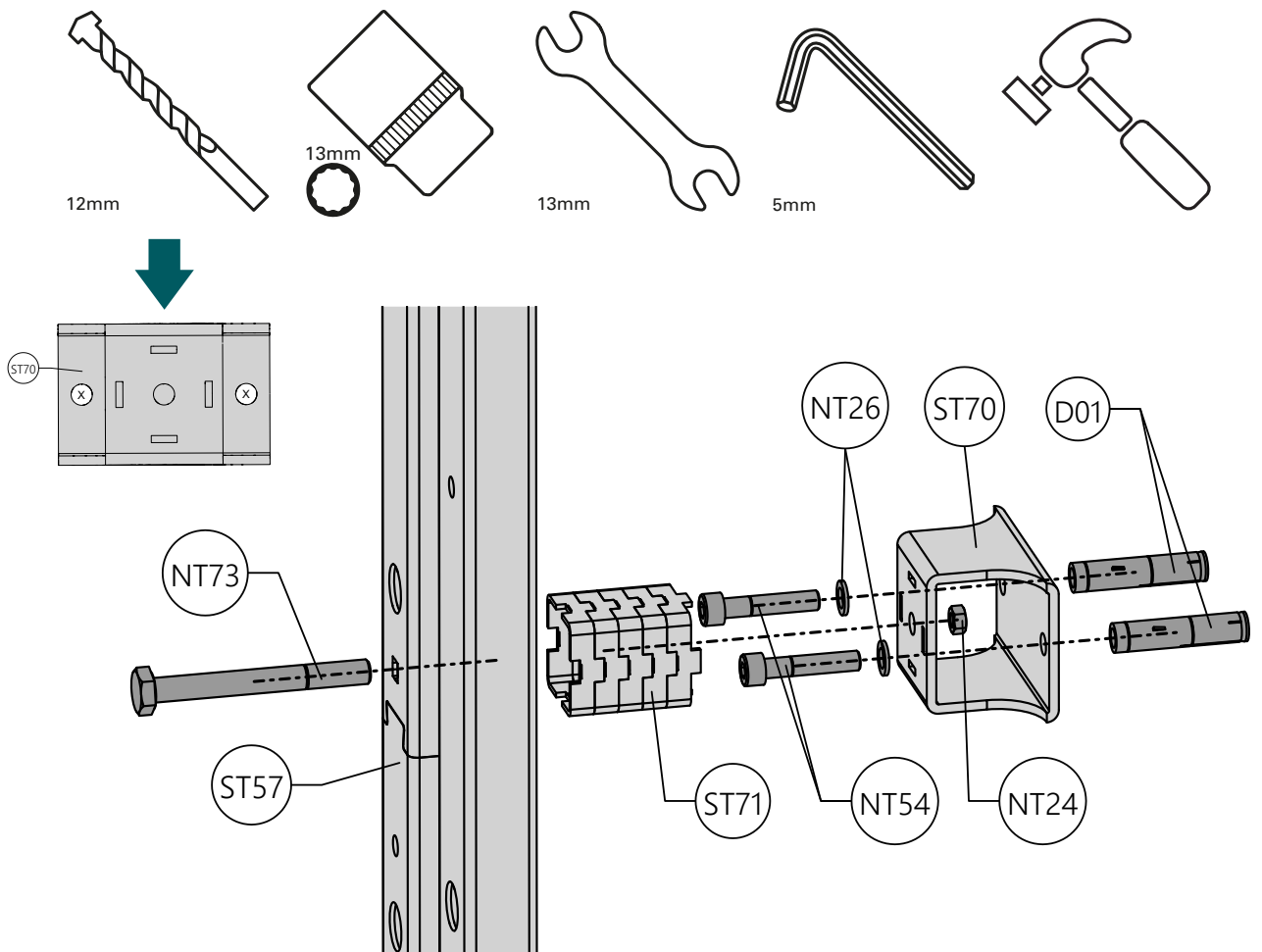

10

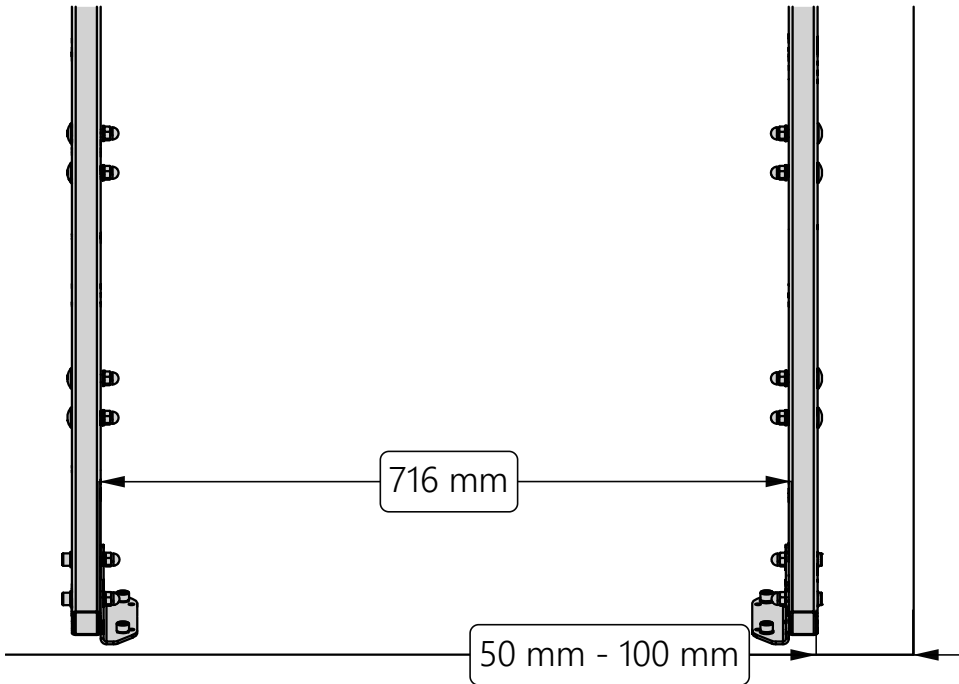
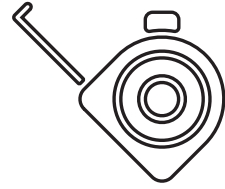
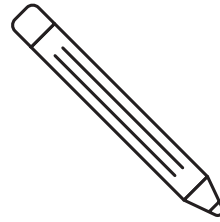

10b

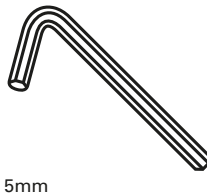

5mm

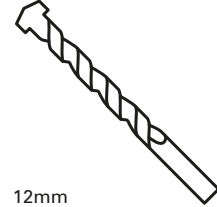
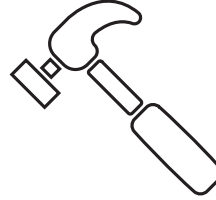

12mm

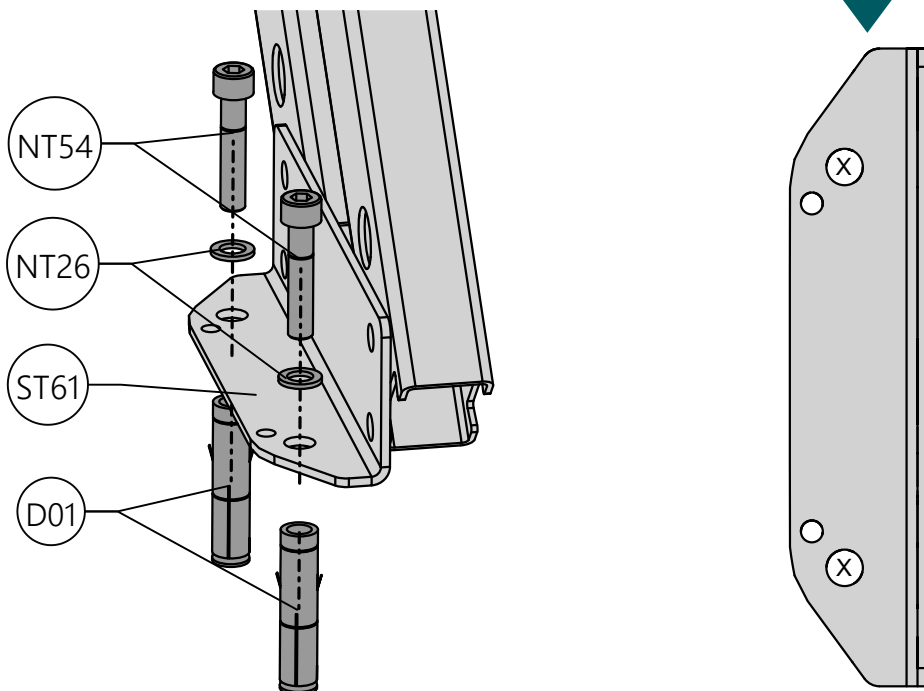

10c

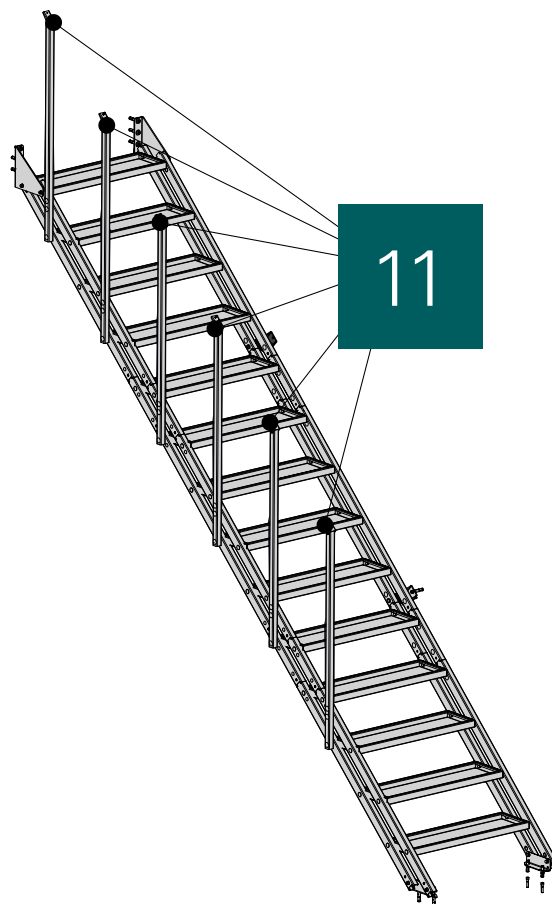
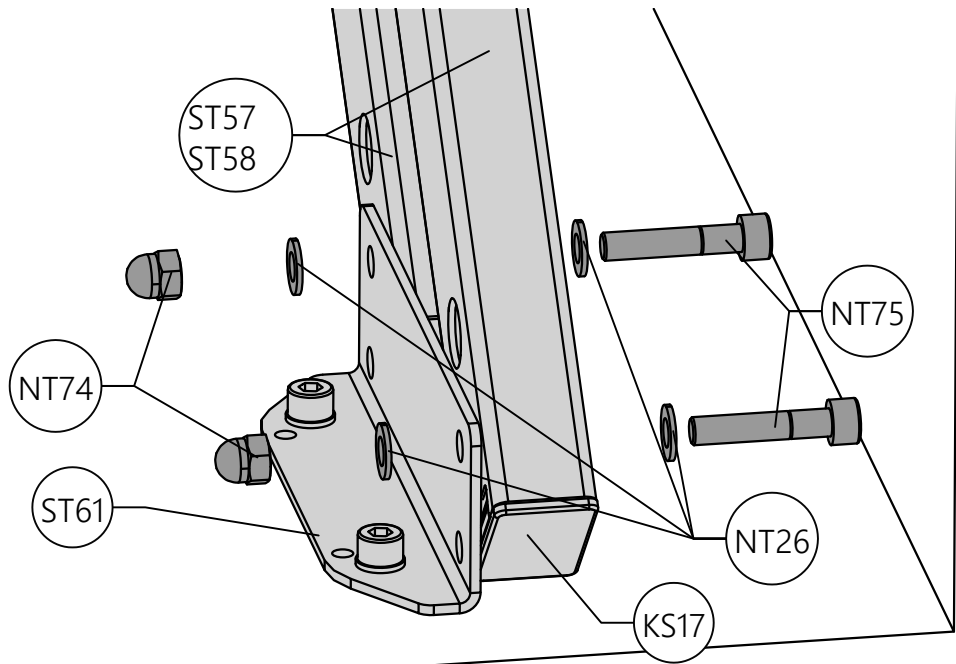
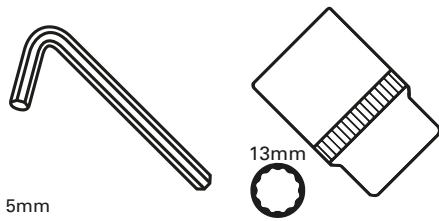

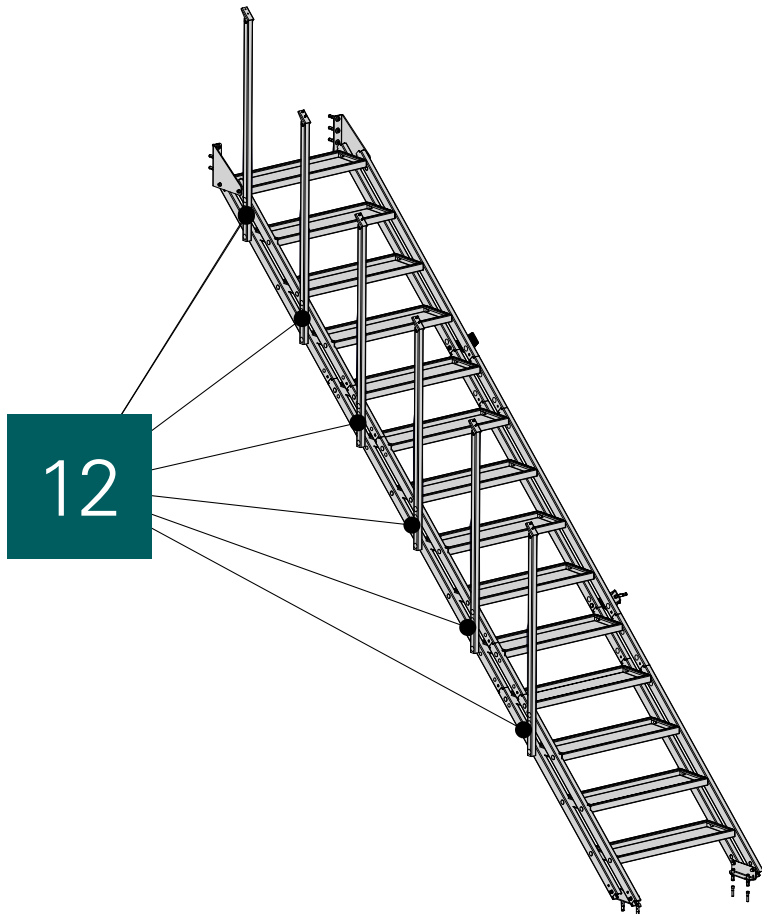
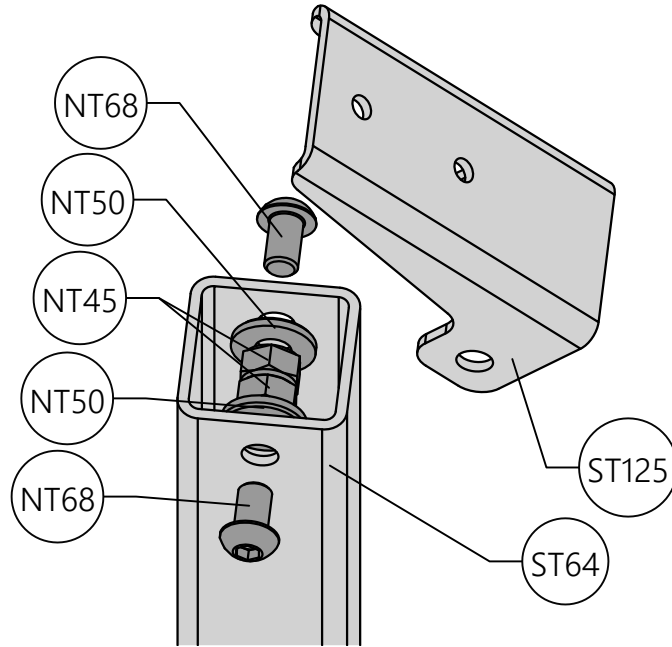
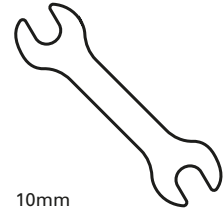
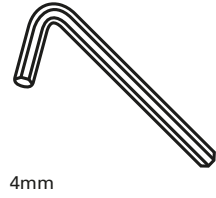

12

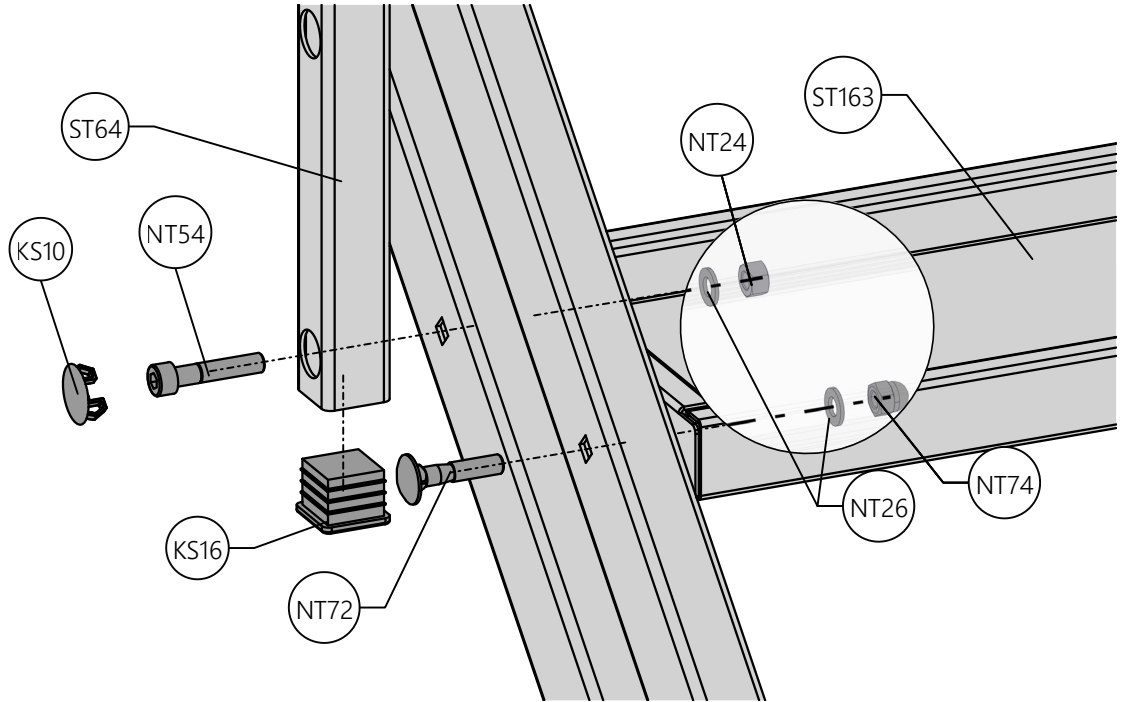
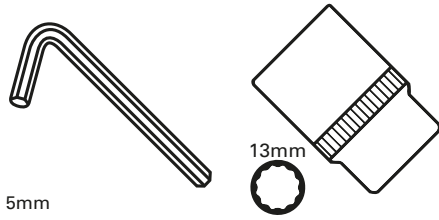

12b

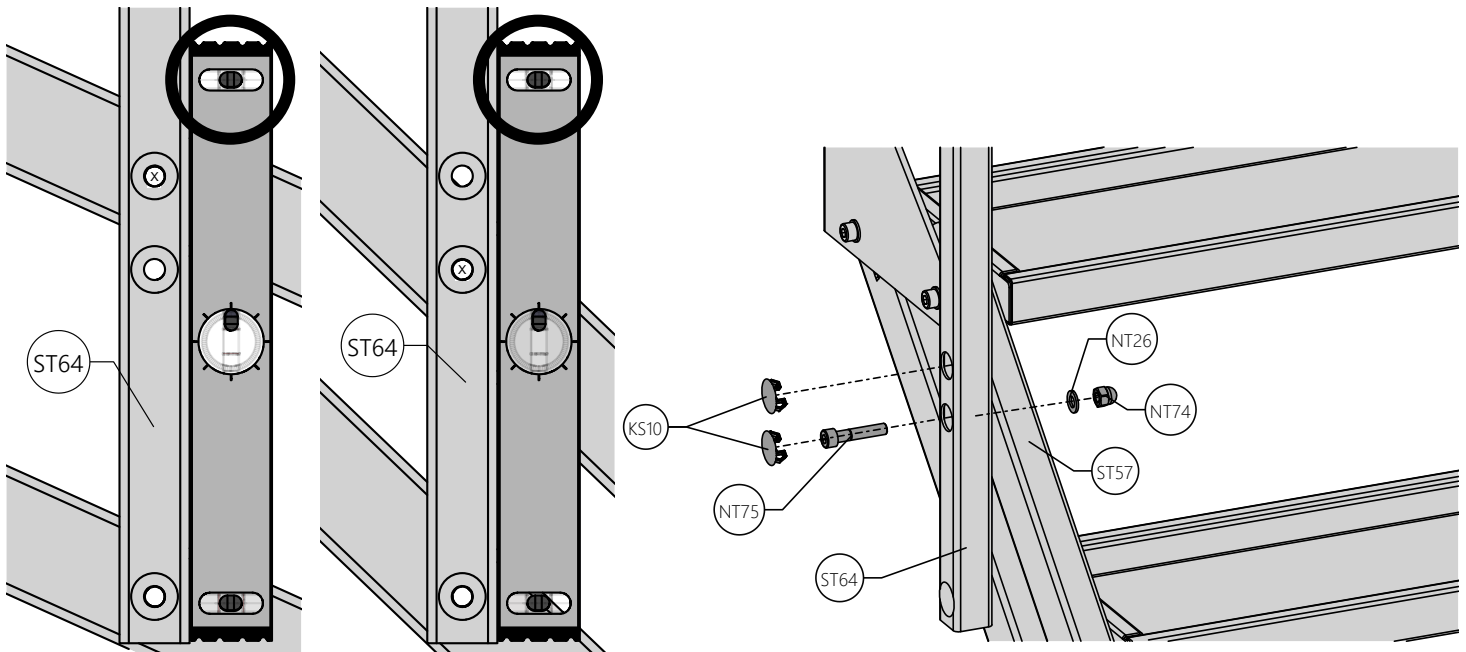
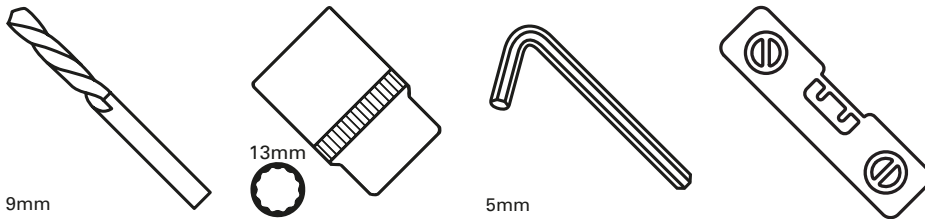

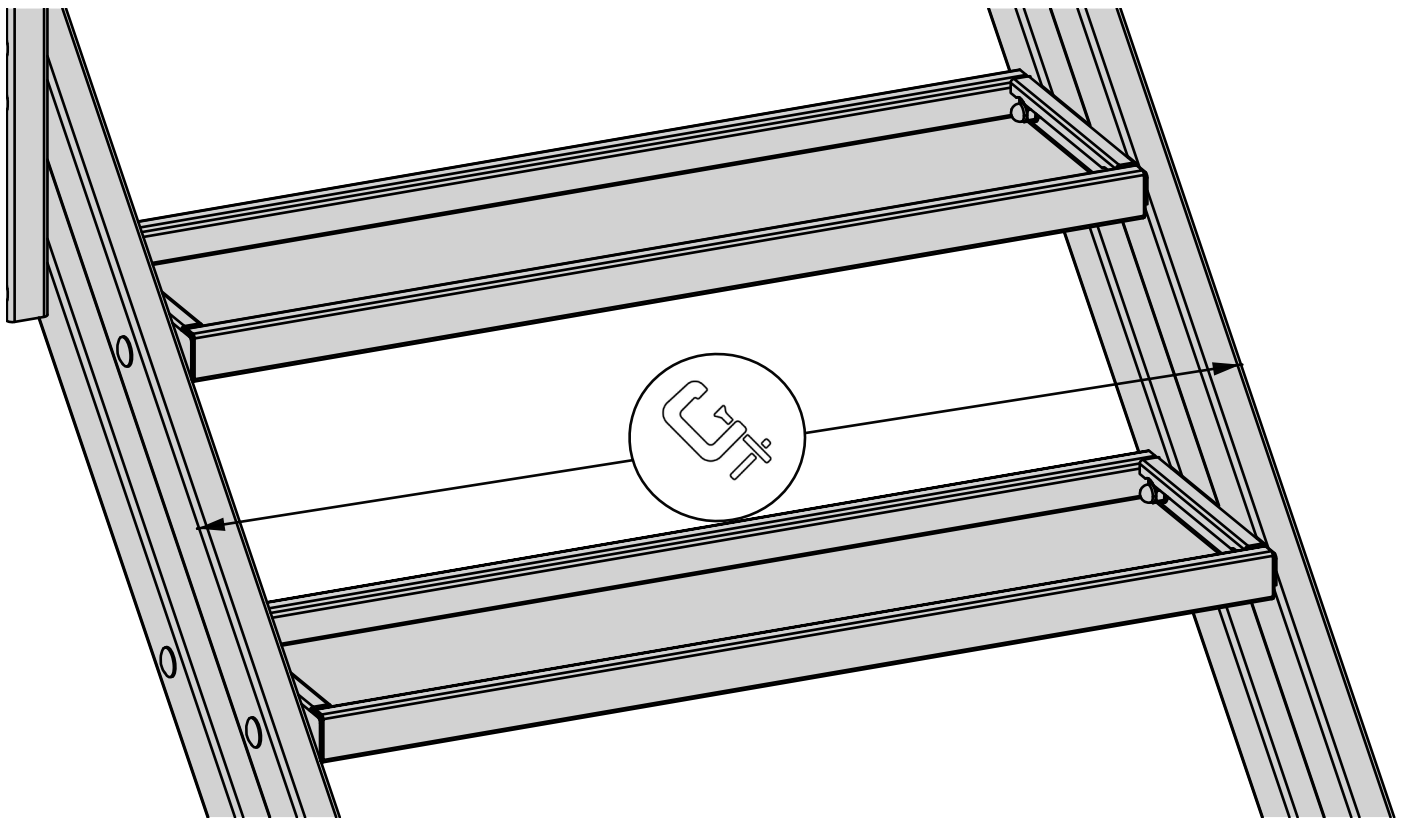

13

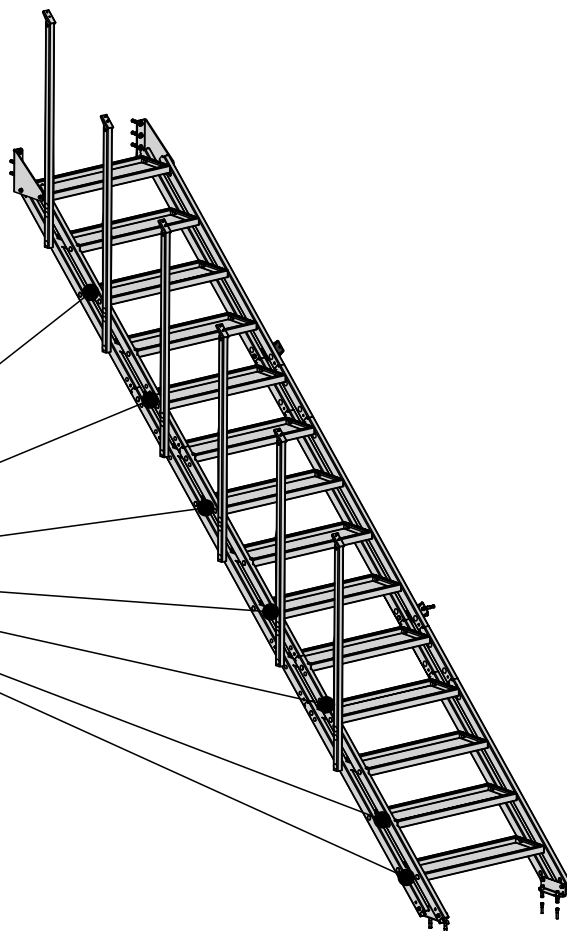

13

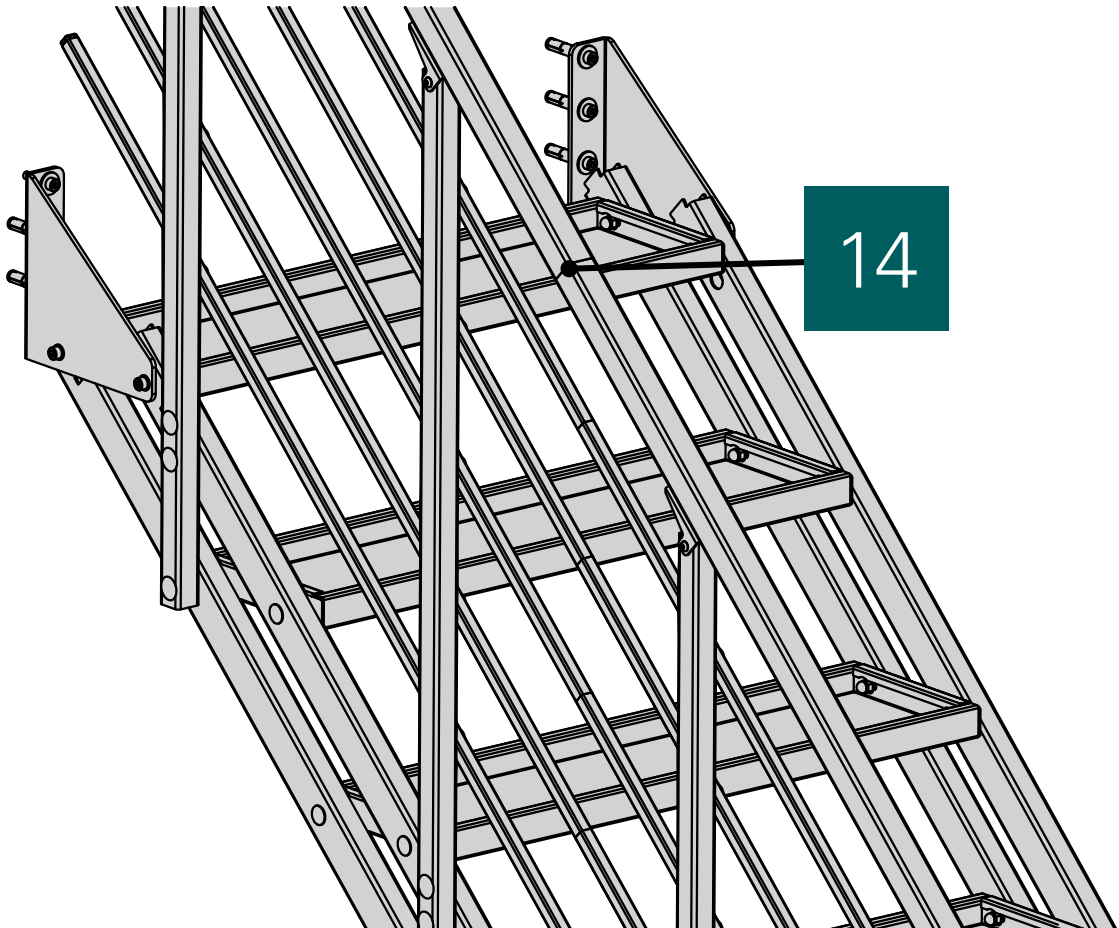
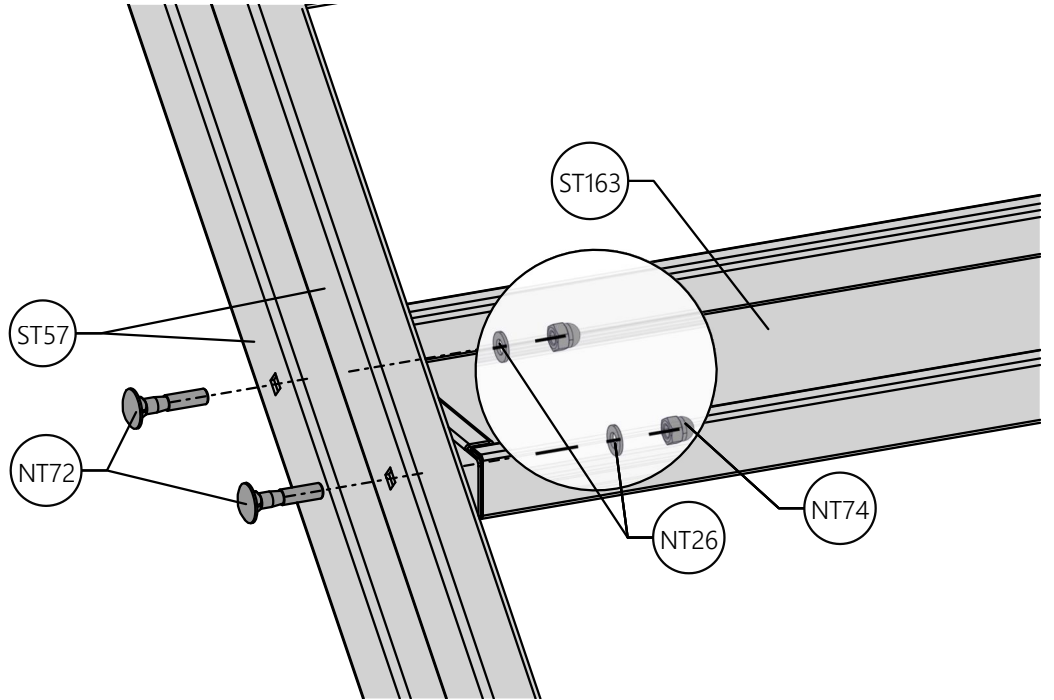
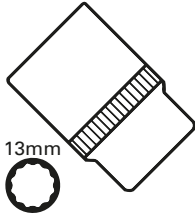

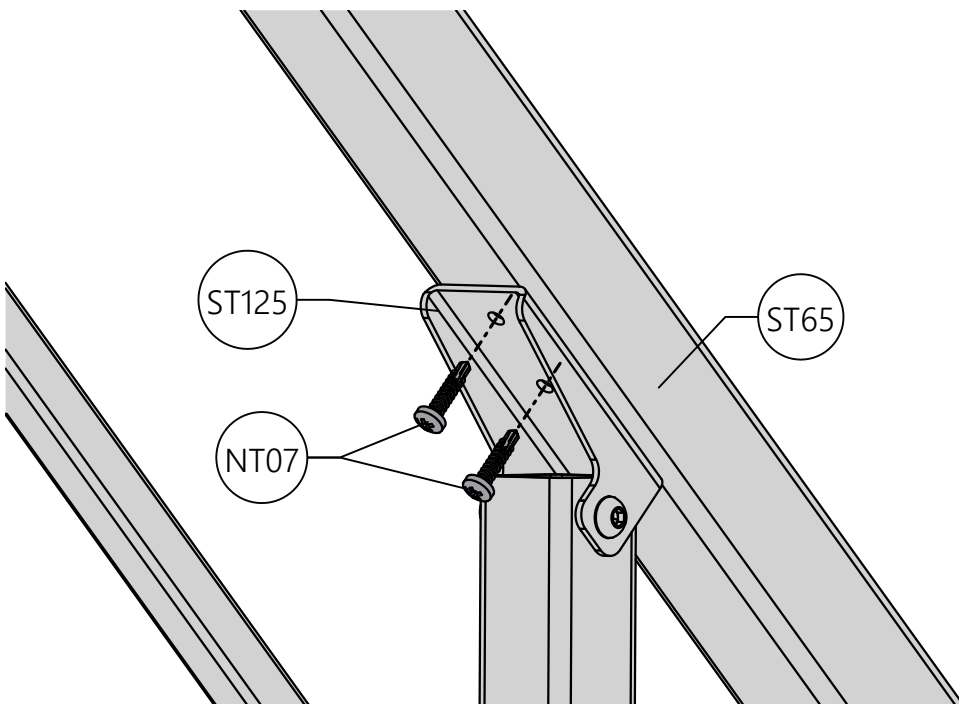
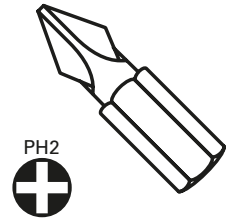
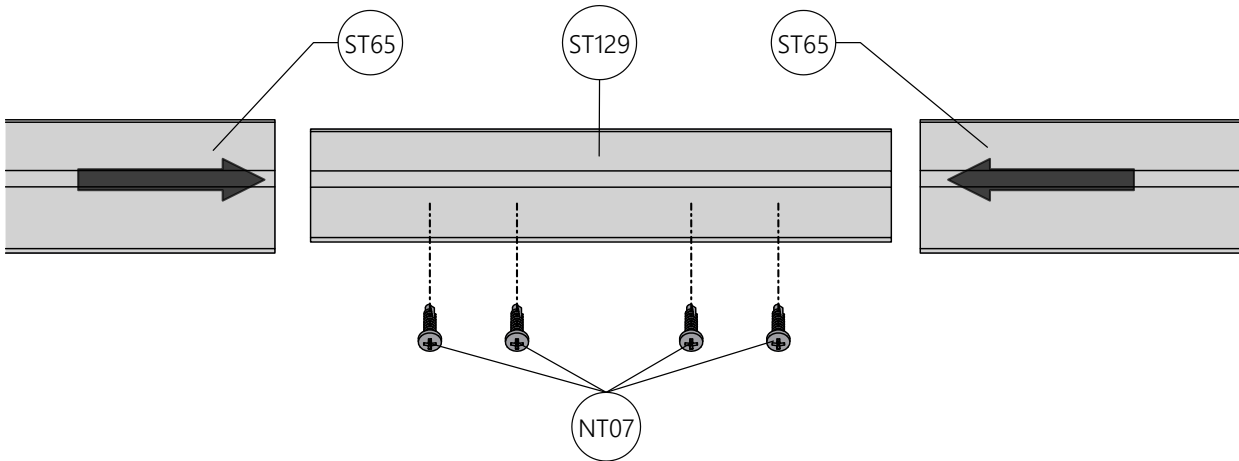
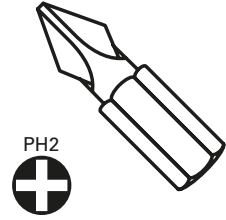

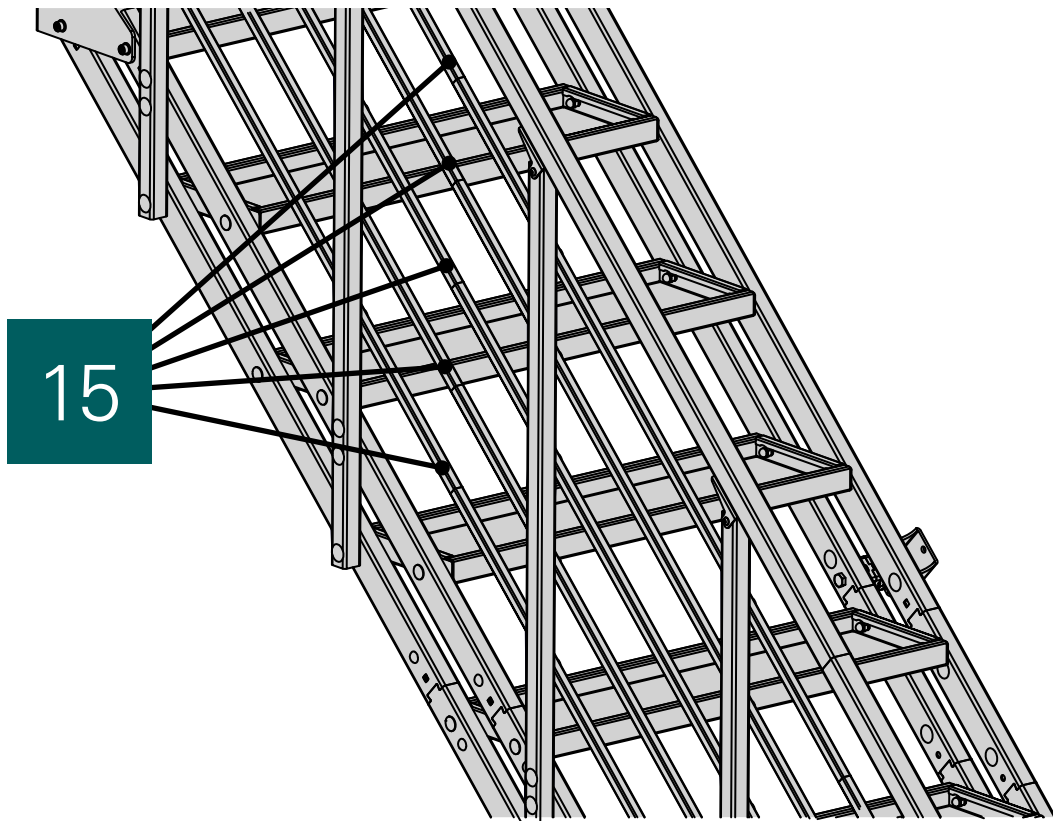

15

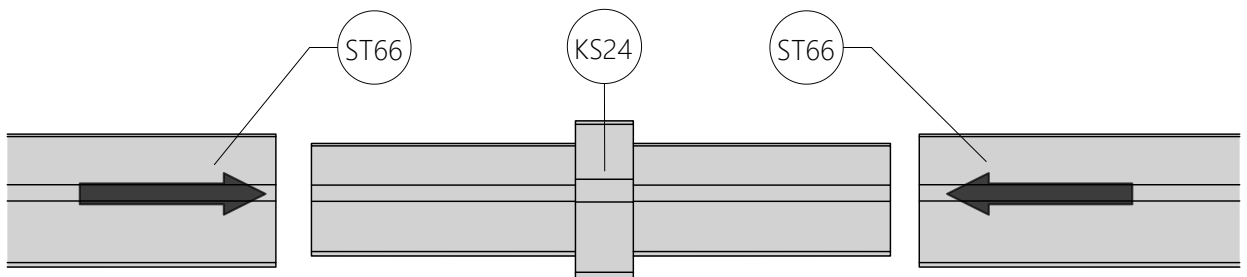
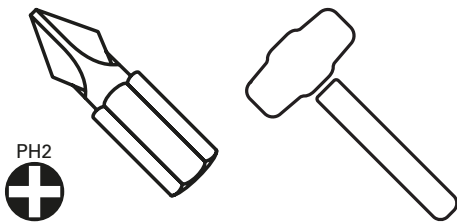

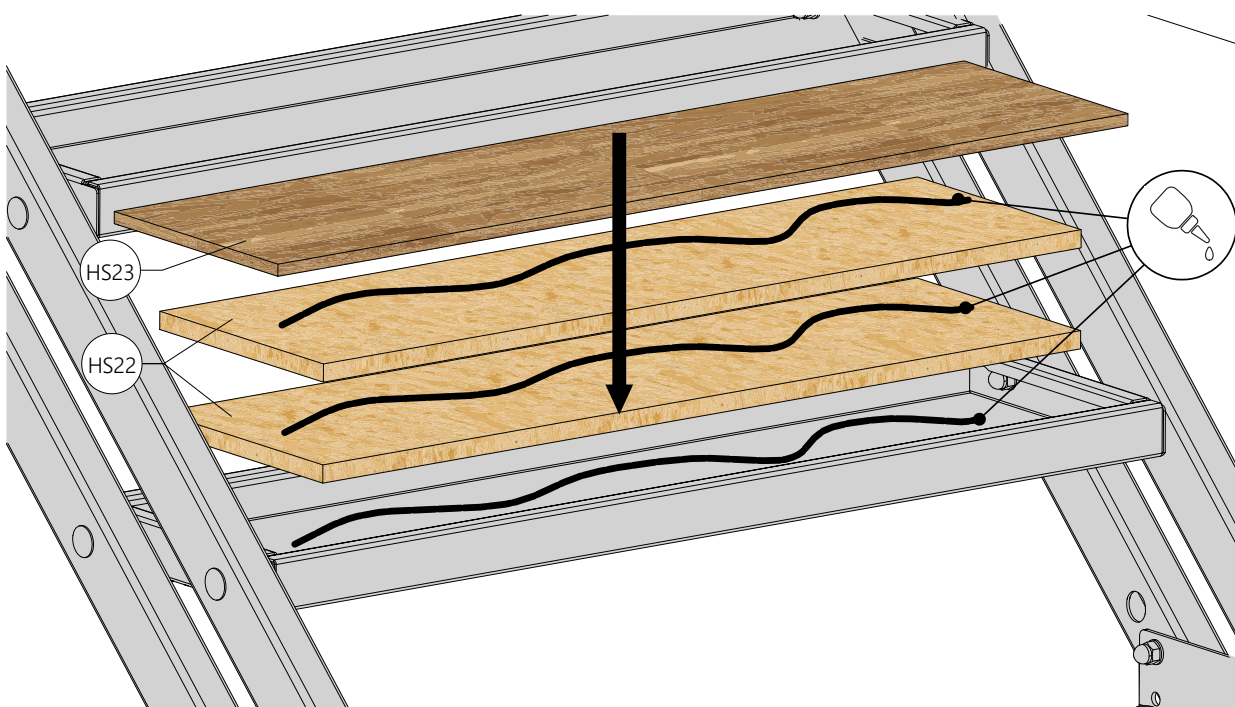
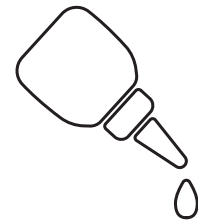
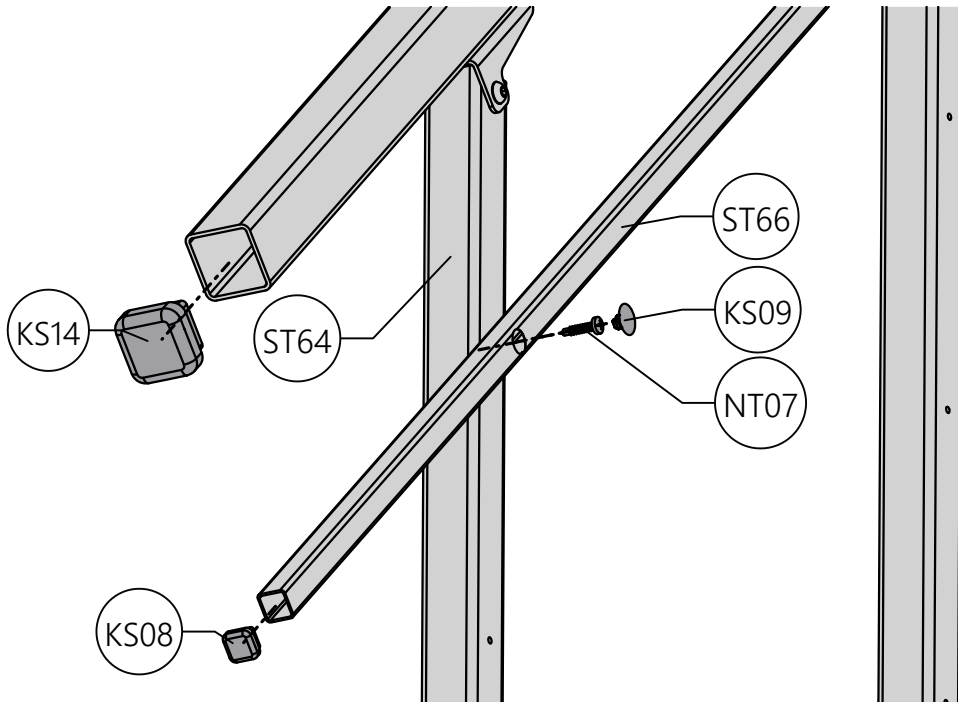
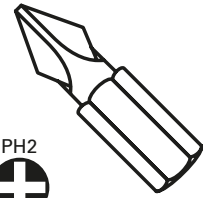



DE Sicherheitshinweise

SE Säkerhetsanvisningar

NL Veiligheidsinstructies

RO Instrucțiuni de siguranță

SK Bezpečnostné pokyny

IT Avvertenze di sicurezza

FR Consignes de sécurité

CZ Bezpečnostní pokyny

DE Beachten Sie bitte, dass die lokalen und konkreten Bestimmungen zu Treppen und Geländern in den Verwaltungsvorschriften, Durchführungsverordnungen oder auch Arbeitsblättern von Landesstellen enthalten sind. Umfassende Information zu den einzuhaltenden bautechnischen Anforderungen können nur seitens der für den Einbauort zuständigen Behörden erfolgen. Diese sind vorab bauseits einzuholen.

IT Tenere presente che le disposizioni locali e le specifiche relative a scale e ringhiere sono contenute nelle norme amministrative, nei regolamenti di esecuzione o anche nelle schede di lavoro degli enti regionali. Solo le autorità competenti del luogo di installazione possono fornire le informazioni complete sui requisiti tecnici, che devono essere richieste anticipatamente dal cliente.

FR Veuillez noter que les dispositions locales et concrètes concernant les escaliers sont contenues dans les dispositions administratives, les décrets d'application ou même les fiches de travail des organismes nationaux. Des informations complètes concernant les exigences structurelles à respecter ne peuvent être fournies que par les autorités compétentes pour l'emplacement de montage. Celles-ci doivent être obtenues au préalable par le client.

NL Houd er rekening mee dat de lokale en specifieke voorschriften met betrekking tot trappen en leuningen zijn opgenomen in de administratieve voorschriften, uitvoeringsvoorschriften of in werkbladen van overheidsinstanties. Uitgebreide informatie over de in acht te nemen bouwtechnische eisen kan alleen gegeven worden door de autoriteiten die verantwoordelijk zijn voor de bouwlocatie. Deze dient vooraf ter plekke ingewonnen te worden.

CZ Mějte prosím na paměti, že v administrativních a prováděcích předpisech nebo pracovních datových listech místních úředních orgánů jsou uvedena místní a konkrétní ustanovení o schodištích a zábradlích. Komplexní informace o stavebně technických požadavcích, které musí být splněny, mohou poskytnout pouze úřady, které mají místo vestavby ve své kompetenci. Ty musejí být zjištěny nejprve na stavbě.

SK Upozorňujeme, že miestne a konkrétne ustanovenia týkajúce sa schodov a zábradlí sú uvedené v správnych predpisoch, vykonávacích nariadeniach alebo aj v pracovných listoch krajských úradov. Komplexné informácie o stavebných požiadavkách, ktoré je potrebné dodržať, môžu poskytnúť iba orgány príslušné pre miesto montáže. Tieto informácie je potrebné získať pred montážou vo vlastnej réžii.

SE Observera att lokala och specifika bestämmelser om trappor och räcken finns i bestämmelser, genomförandeförordningar och även arbetsblad från lokala myndigheter. Omfattande information om de byggnadstekniska krav som ska följas kan endast lämnas av de behöriga myndigheterna på installationsorten. Den ska inhämtas i förväg på byggplatsen.

RO Rețineți că dispozițiile locale și concrete privind scările și balustradele sunt incluse în normele administrative, în normele de aplicare sau în fișele de lucru ale autorităților responsabile la nivel de land. Informații detaliate privind normele tehnice de construcție care trebuie respectate pot fi furnizate numai de către autoritățile competente de la locul de montare. Acestea trebuie obținute în prealabil de către client.

Manufactured for:
HORNBACH Baumarkt AG
Hornbachstraße 11
76879 Bornheim / Germany
product@hornbach.com
www.hornbach.com

Technische Information, Stand 06/2026
Information technique, version 06/2026
Informazioni tecniche, versione 06/2026
Technische informatie, stand 06/2026
Teknisk information, senast uppdaterad 06/2026
Technické informácie, aktualizované 06/2026
Informații tehnice, versiunea 06/2026