









Art.-Nr.: 45.301.50

I.-Nr.: 21014

	XT 60
Nennleistung / Nominal Power (P)	40W*
Leerlaufspannung / Open circuit voltage (Uoc/Voc)	24.5V*
Kurzschlussstrom / Short circuit current (Isc)	2.07A*
Nennleistungsspannung / Voltage at nominal power (Ump/Vmp)	20.5V*
Nennleistungsstrom / Current at nominal power (Imp)	1.95A*
Zell-Umwandlungseffizienz / Cell conversion efficiency	≥ 23%*
* bei folgenden Testbedingungen / at following test conditions (STC)	Bestrahlungsstärke / Irradiance: 1000 W/m ² Zelltemperatur / Cell temperature (TC): 25 °C Luftmasse / Air mass (AM): 1.5

	USB-C PD 3.0	USB-A QC 3.0
Ausgang (Leistung / Spannung / Stromstärke) Output (Power / Voltage / Current)	30 W max.	18 W max.
	5V  3A	5V  3A
	9V  3A	9V  2A
	12V  2A	12V  1.5A
	15V  2A	
	20V  1.5A	

Rote LED / Red LED	
LED leuchtet / LED lights up	USB-A / USB-C Normales Arbeiten / Normal work
LED blinkt / LED flashes	USB-A / USB-C Solar Energie nicht stark genug / Solar energy not strong enough
LED aus / LED off:	USB-A / USB-C Kein Ausgang / No output

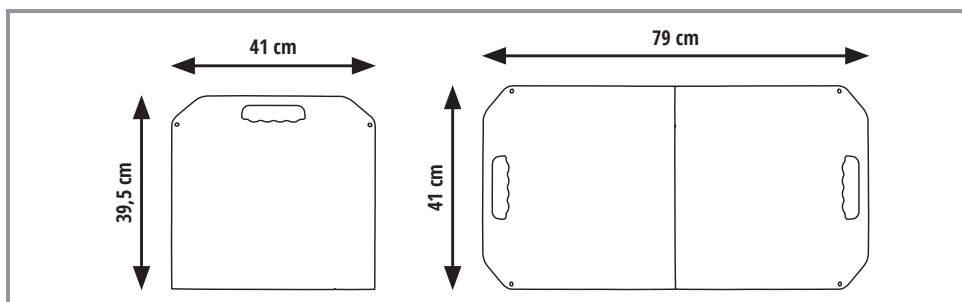

EH 03/2025 (01)