

home protect

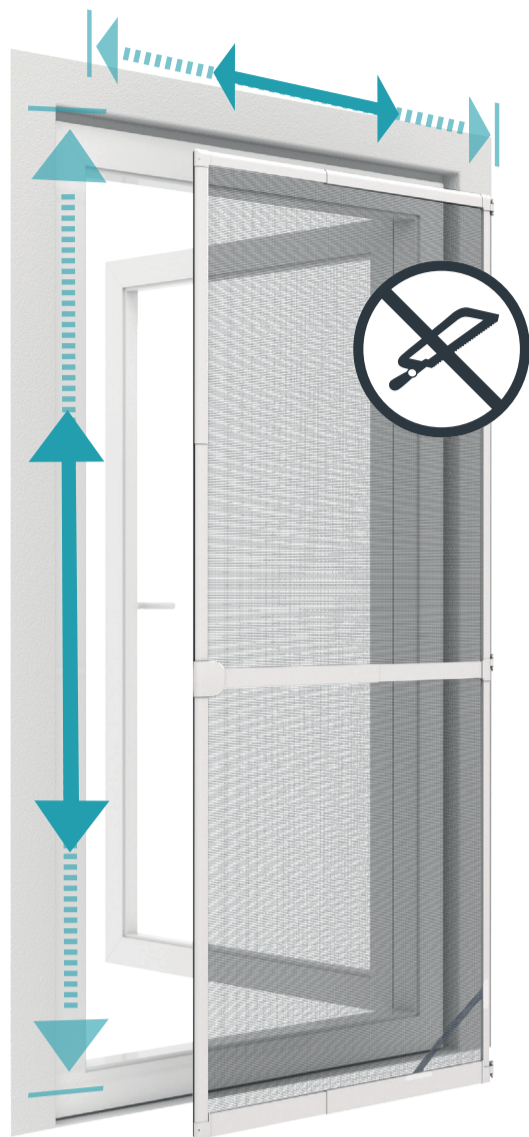

max. 100 x 215 cm
min. 65 x 169 cm

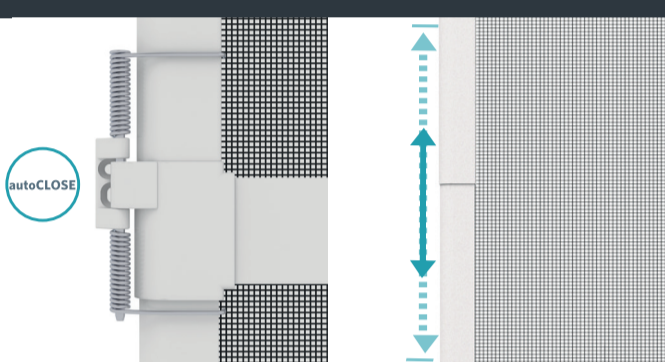

Teleskop-Insektenschutz-Tür

individuell anpassbar

DE Teleskop-Insektenschutz-Tür

Individuell anpassbar

F Cadre pour portes télescopique

adaptable individuellement

I Zanzariere per porte teleskopio

adattabile individualmente

NL Insectenwerende frames voor deuren

Individueel aanpasbaar

S Insektsskyddsramar för dörrar

Individuellt anpassningsbar

CZ Ochranný rám proti hmyzu do dveře

Individuálně přizpůsobitelné

SK Rám dverí so sieťou proti hmyzu

Individuálně přizpůsobitelné

RO Cadru anti-insecte pt ușile

Adaptabil individual

EN Insect screen door with telescope frame

Individually adaptable



www.blauer-engel.de/uz34

DE www.hornbach.de
AT www.hornbach.at
LU www.hornbach.lu
CH www.hornbach.ch
NL www.hornbach.nl
CZ www.hornbach.cz
SK www.hornbach.sk
RO www.hornbach.ro

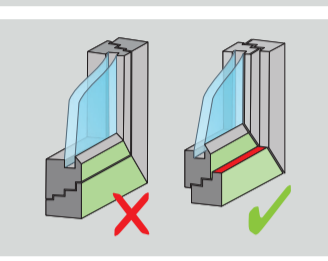
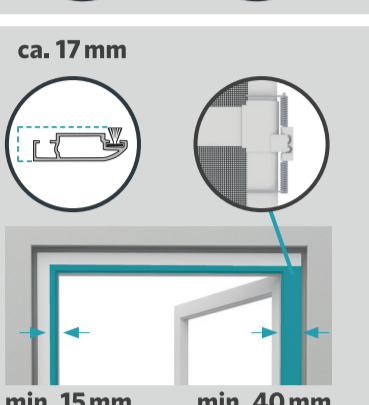
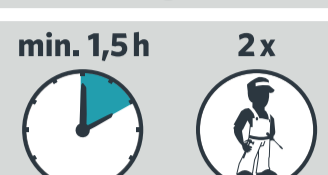
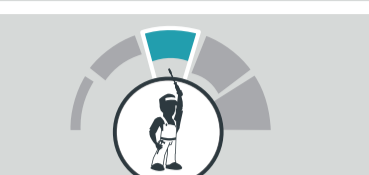

home protect

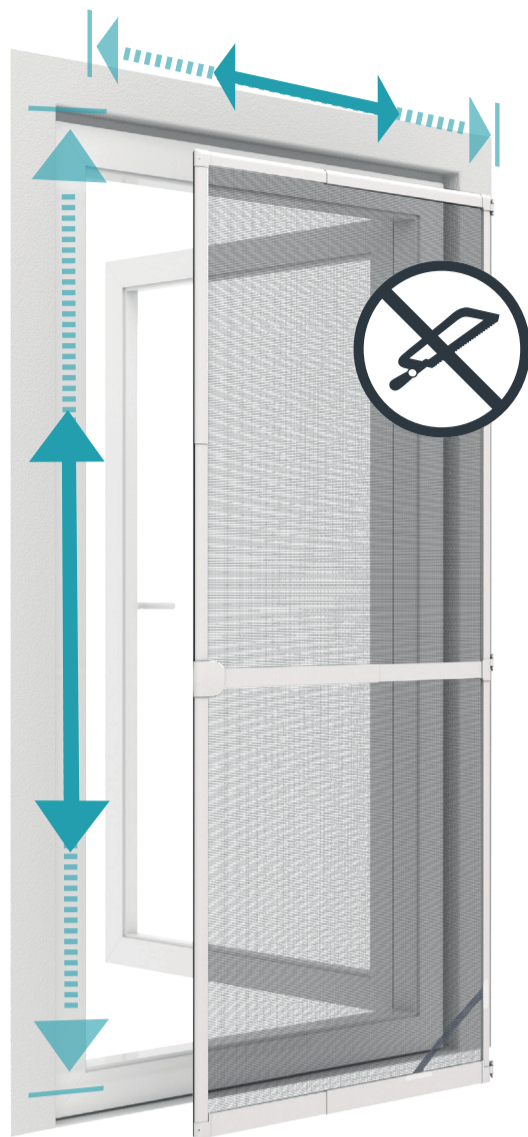

max. 100 x 215 cm
min. 65 x 169 cm

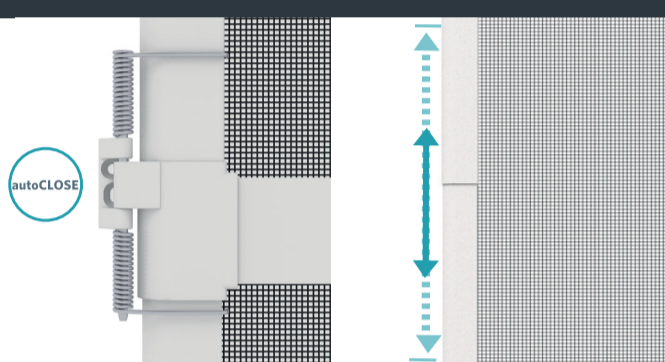

Teleskop-Insektenschutz-Tür

individuell anpassbar

F Cadre pour portes télescopique

adaptable individuellement

I Zanzariere per porte teleskopio

adattabile individualmente

NL Insectenwerende frames voor deuren

Individueel aanpasbaar

S Insektsskyddsramar för dörrar

Individuellt anpassningsbar

CZ Ochranný rám proti hmyzu do dveře

Individuálně přizpůsobitelné

SK Rám dverí so sieťou proti hmyzu

Individuálně přizpůsobitelné

RO Cadru anti-insecte pt ușile

Adaptabil individual

EN Insect screen door with telescope frame

Individually adaptable

F Cadre pour portes télescopique

adaptable individuellement

I Zanzariere per porte teleskopio

adattabile individualmente

NL Insectenwerende frames voor deuren

Individueel aanpasbaar

S Insektsskyddsramar för dörrar

Individuellt anpassningsbar

CZ Ochranný rám proti hmyzu do dveře

Individuálně přizpůsobitelné

SK Insektsskyddsramar för dörrar

Individuálně přizpůsobitelné

RO Cadru anti-insecte pt ușile

Adaptabil individual

EN Insect screen door with telescope frame

Individually adaptable

100% Fiberglas

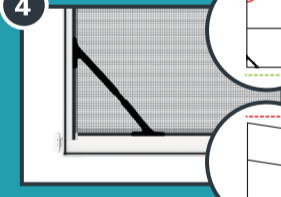
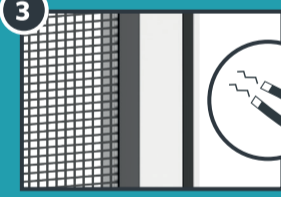
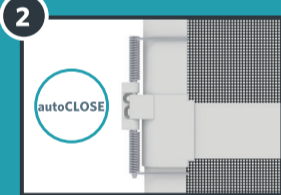
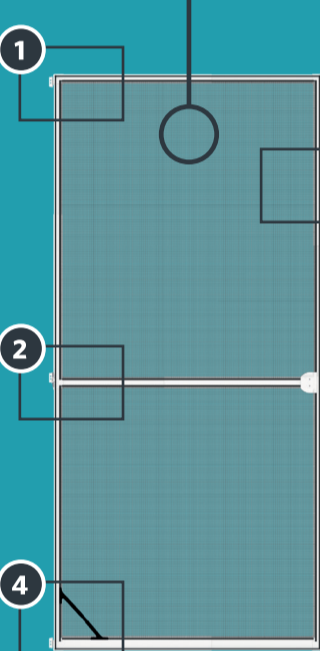

DE: Achtung! Plastiktüten sind kein Spielzeug. Bitte von Kindern fernhalten. Erst bei Rückgabe getrennt entsorgen! Lokale Entsorgungsmöglichkeiten beachten.

F: Attention! Les emballages plastiques ne sont pas des jouets. Tenir à l'écart des enfants. Risque de suffocation. Jeter séparément - Observer les options d'élimination locales.

I: Attenzione! Sacchetti di plastica non sono giocattoli. Tenere lontano dai bambini. Pericolo di soffocamento! Smaltire separatamente. Osservare le opzioni di smaltimento locali.

NL: Let op! Plastic zakken zijn geen speelgoed. Vanwege verstikkingsgevaar weghouden bij kinderen en dieren. Afzonderlijk wegdoen. Neem de plaatselijke verwijderingsmogelijkheden in acht.

S: Varning! Plastpåsar är inga leksaker. Vänligen håll borta från barn. Risk för kvävning. Sortskaffa separat - Observera lokala möjligheter till avfallshantering.

CZ: Upozornění! Plastový sáček není hračka. Udržujte mimo dosahu dětí. Nebezpečí udušení! Likvidujte odděleně - Dodržujte místní možnosti likvidace.

SK: Upozornenie! Plastové vrecko nie je hračka. Udržujte mimo dosahu detí. Nebezpečenstvo udusenia! Zlikvidujte oddelene. Dodržujte miestne možnosti likvidácie.

RO: Atenție! Pungile de plastic nu sunt jucării. Țineți departe de copii. Pericol de sufocație! Eliminați separat și respectați posibilitățile locale de eliminare.

EN: Warning! Plastic bags are not toys. Keep away from babies and children. Danger of Suffocation! Dispose of separately - Observe local disposal options.



24
easy life GmbH
Industriestraße 5
D-91583 Schillingsfürst

Artikel-ID: 580-2130
DOP_580-2130_580-2132
www.easy-life.de/kontakt/datenschutz-copy

Widerstand gegenüber Windlasten
Résistance aux charges de vent
Resistenza ai carichi del vento
Weerstand tegen windbelasting
Motståndskraft mot vindlast
Odolnost proti zatížení větrem
Odolnost proti zatíženiu vetrom
Rezistență la vânt
Resistance to wind loads

EN 13561:2015 / AC:2016

DE: Insektenschutzgitter für den Außenbereich von Gebäuden F: Moustiquaires pour l'extérieur des bâtiments I: Zanzariere per l'esterno degli edifici NL: Insectenhorren voor de buitenkant van gebouwen. S: Insektsskyddsramar för utsidan av byggnader CZ: Síť proti hmyzu pro exteriér budov SK: Sieť proti hmyzu pre exteriér budov RO: Plase împotriva insectelor pentru exteriorul clădirilor EN: Insect screens for the exterior of buildings



Made in: PRC
easy life GmbH
Industriestraße 5
91583 Schillingsfürst/Germany
info@easy-life.de
www.easy-life.de

home protect

Art.-Nr. 580-2130
Charge: MMXIV-01



4 052329 014141